



LEVEL
 PRESSURE
 TEMPERATURE
 INSTRUMENTATION
 PASTEURIZATION CONTROLS

MICROBASED 1/4 DIN SINGLE LOOP CONTROLLER

AIC200

Installation, Wiring, Operation Manual

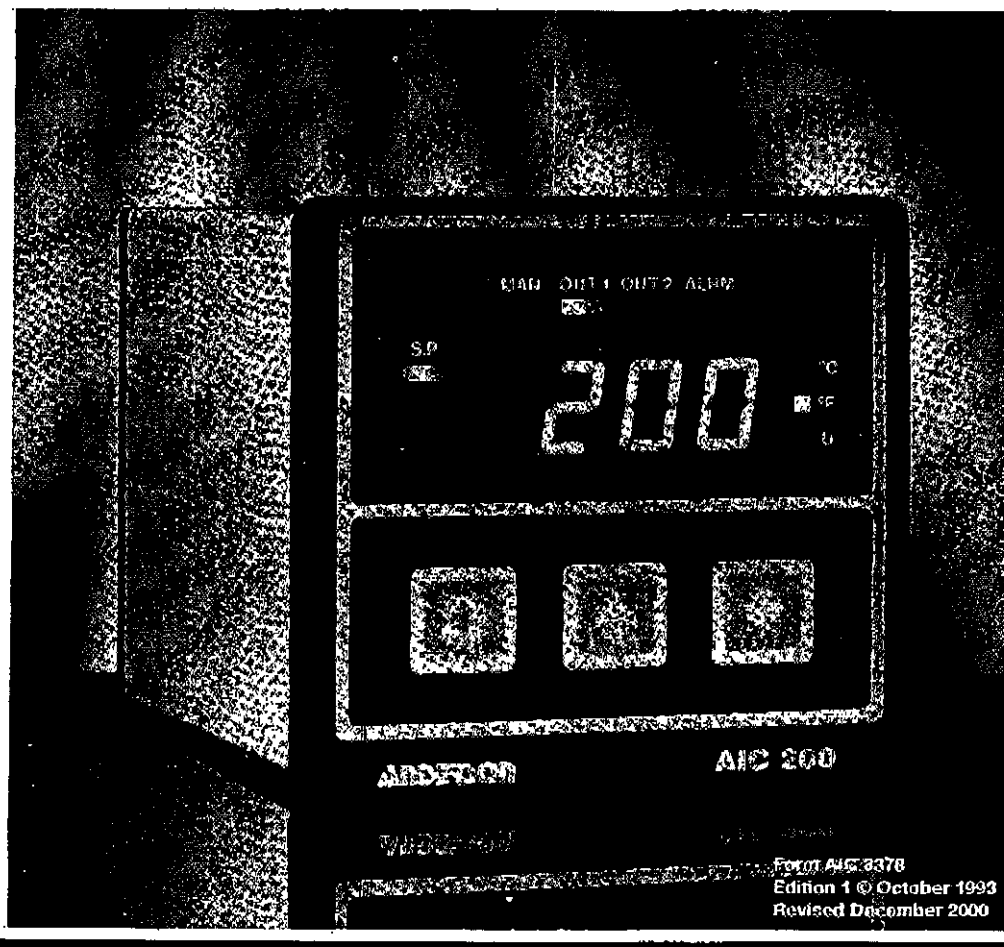

PAGE 2

Would you like information on our other products?

**Make a copy of this page, check next to the products you
are interested in and fax it to us at 1-518-922-8997 or
just call us at 1-800-833-0081**

Gauges
 Thermometers
 Transmitters*
 RTDs

Recorders
 Controllers
 Liquid Level Systems

Your Name

Company Name

Street Address

City, State, Zip/ Postal Code, Country, and Telephone Number

Request form from AIC 200 Manual

Table of Contents

SECTION 1 - GENERAL

1.1 Product Description

Page Number

5

SECTION 2 -

INSTALLATION & WIRING

2.1 Installation and Wiring

7

2.2 Preparation for Wiring

8

2.3 Input Connections

13

2.4 Output Connections

19

SECTION 3 -

CONFIGURATION & OPERATION

3.1 Configuration and Operation

22

3.2 Operation Summary

22

3.3 Configuration Summary

24

3.4 Tune Mode Operation

34

SECTION 4 - CONTROL CAPABILITY

4.1 Control Capability

37

4.2 Control Responses

37

4.3 Direct/Reverse Operation of Control Outputs

37

4.4 On-Off Control/Latched On-Off

38

4.5 Time Proportioning Control

38

4.6 Current Proportioning Control

38

4.7 Position Proportioning Control

38

4.8 Dual Output Control

40

4.9 Manual Operation of Proportional Outputs

41

4.10 Automatic Transfer Function

41

4.11 Setpoint Adjustments

42

SECTION 5 - SERVICE

5.1 Service

44

5.2 Calibration

44

5.3 Test Mode

48

5.4 Troubleshooting and diagnostics

52

APPENDICES

A - Board Layout - Jumper Positioning

Figure A-1 Power Supply Board

59

Figure A-2 Processor Board

60

Figure A-3 Option Board

61, 62

B - Glossary of terms

63

C - Model Number Hardware Matrix Details

66

D - Specifications

67

E - Software Record/Reference Sheet

70

Warranty

Inside back cover

PAGE 4**FIGURES & TABLES**

Figure 1-1	Controller Display Illustration	5
Figure 2-1	Panel Opening Sizes and Installation	7
Figure 2-2	Noise Suppression	9
Figure 2-3	Noise Suppression	10
Figure 2-4	Wiring Label	13
Figure 2-5	AC Power	13
Figure 2-6	Thermocouple Input	14
Figure 2-7	RTD Input	14
Figure 2-8	Volt, mV, mADC Input	15
Figure 2-9A	24VDC Transmitter Power Supply	16
Figure 2-9B	24VDC Power Supply	16
Figure 2-10	Remote Setpoint Input	17
Figure 2-11	Remote Digital Communications	18
Figure 2-12	Relay Output	19
Figure 2-13	SSR Driver Output	20
Figure 2-14	mADC Output	21
Figure 2-15	Position Proportioning Output	21
Figure 4-1	Proportional Bandwidth effect on Output	39
Figure 4-2	Dual Proportional Outputs	40
Figure 4-3	Setpoint Ramp Rate Example	42
Figure 4-4	Re-transmission Example	43
Figure 4-5	Setpoint Re-transmission Example	43
Table 3-1	Enable Mode Configuration Procedures	24
Table 3-2	Program Mode Configuration Procedures	28
Table 3-3	Tune Mode Configuration Procedures	33
Table 5-1	Calibration Procedures	45
Table 5-2	Test Procedures and Description	49

FLOW CHARTS

Flow - Calibration	44
Flow - Enable Mode	25
Flow - Program Mode	26
Flow - Setpoint	42
Flow - Standby Mode	41
Flow - Test Mode	48
Flow - Tune Mode	32

Product Description 1.1

1.1.1 GENERAL

This instrument is a microprocessor based single loop controller capable of measuring, displaying and controlling temperature, pressure, flow, and level from a variety of inputs.

Control functions, alarm settings and other parameters are easily entered through the front keypad. All user's data can be protected from unauthorized changes with it's ENABLE MODE security system. Battery back-up protects against data loss during AC power outages.

The input is user configurable to directly connect to either thermocouple, RTD, mVDC, VDC or mADC inputs. Thermocouple and RTD linearization, as well as thermocouple cold junction compensation is performed automatically. The sensor input is isolated. The instrument can operate on either 115VAC or 230VAC power at 50/60Hz. It is housed in an extruded aluminum enclosure suitable for panel mounting. It may be surface mounted using an optional adaptor.

FIGURE 1-1

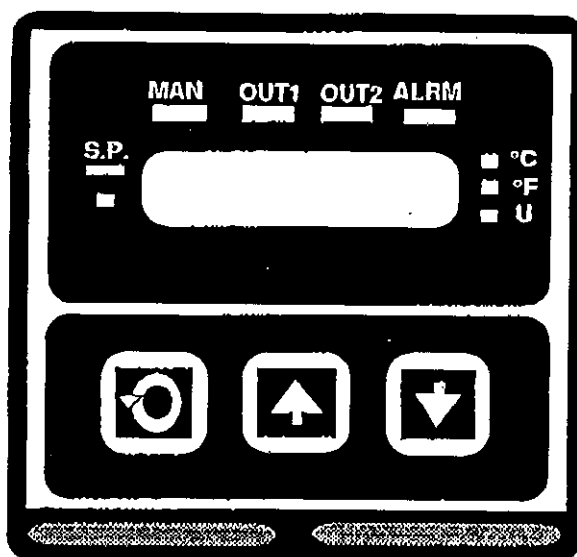

1.1.2 DISPLAYS

Each instrument is provided with a digital display and status indicators as shown in Figure 1-1. The digital display is programmable to show the process variable only, process variable and setpoint, deviation from setpoint only, deviation and setpoint, or setpoint continuously. Status indication is as shown (Figure 1-1). Display resolution is programmable for 0 to 3 decimal places depending upon the input type selected.

PAGE 6**1.1.3 CONTROL**

The instrument can be programmed for on-off, time proportioning, current proportioning, or position proportioning control implementations depending on the model number. A second control output is an available option. Proportional control implementations are provided with fully programmable separate PID parameters.

1.1.4 ALARM

Alarm indication is standard on all instruments. Alarm type may be set as PROCESS DIRECT or REVERSE (High or Low), DEVIATION DIRECT or REVERSE (Above or Below setpoint), or DEVIATION BAND TYPE (Closed or Open within the band). Alarm status is indicated by LED. An alarm output can be provided by assigning any output(s) SPST relay(s) or SSR Driver(s) to the alarm.

1.1.5 EXTENDED FEATURES SOFTWAREEA Software Features

Fast Scan	Provides an optional faster scan rate of 3 scans per second. Normal scan is one scan per second.
Process Rounding	Provides rounding of the process value displayed to reduce display fluctuation. For example, the displayed value can be rounded to the nearest 5 (display -5, 0, 5, 10, etc.). This is for display only and does not affect the control action.
Extended Current Output Ranges	The current outputs available can be extended to include 0-20mA and 0-5VDC (with the appropriate shunt resistor), rather than the standard 4-20mA and 1-5VDC outputs.
Process/Setpoint Retransmit Capability	The process or setpoint value can be scaled over any desired range and retransmitted using one of the current outputs. (This precludes the use of the output for control).
Percent Output Relay Actuation	Provides a relay actuation based upon a proportional output being above or below a specified value.
Contact Closure Sensing for SP = PV	This feature provides the following action: When a contact closure is sensed, the setpoint will be set equal to the current process value. This is only done on the transition from open to closed, and not continuously while the switch is closed.

EB Software Features

Setpoint Ramp Rate	Provides a limitation on how fast the process value will ramp to setpoint by limiting the rate of change of an internal setpoint used for control versus the setpoint the operator specifies.
--------------------	---

Installation and Wiring 2.1

Prior to proceeding with installation, verify the AC power input required by the instrument. AC power input is either 115 VAC or 230 VAC and is specified in the model number and on the wiring label affixed to the instrument housing. See Figure 2-2 (page 8) for a wiring label description.

230 VAC models may be converted to 115 VAC operation by the user, by changing the position of jumpers soldered on the Power Supply Board, see Appendix A-1 (page 59) for details.

Electrical code requirements and safety standards should be observed and installation performed by qualified personnel.

The electronic components of the instrument may be removed from the housing during installation. To remove the components, loosen the locking screw located in the lower center of the instrument's front panel. Pull the entire instrument straight out of the housing. During re-installation, the vertically mounted circuit boards should be properly aligned in the housing. Be sure that the instrument is installed in the original housing. This can be verified by matching the serial number on the unit to the serial number on the housing. (Serial numbers are located on the inside of the housing enclosure and on the label on the underside of the front panel). This will insure that each instrument is accurate to its published specifications. The ambient compensator on the rear of the housing enclosure is calibrated to the electronics of the instrument at the factory.

Recommended panel opening sizes are illustrated below (Figure 2-1). After the opening is properly cut, insert the instrument housing into the panel opening. Insert the two panhead screws provided, through the holes in the mounting bracket into the holes in the rear of the instrument as shown in Figure 2-1. Firmly tighten the screws. Instruments are shipped standard for panel mounting. To surface mount, an adaptor is required and should be specified when ordering. For installation in wash-down areas, a watertight cover is available.

FIGURE 2-1 PANEL OPENING SIZES AND INSTALLATION

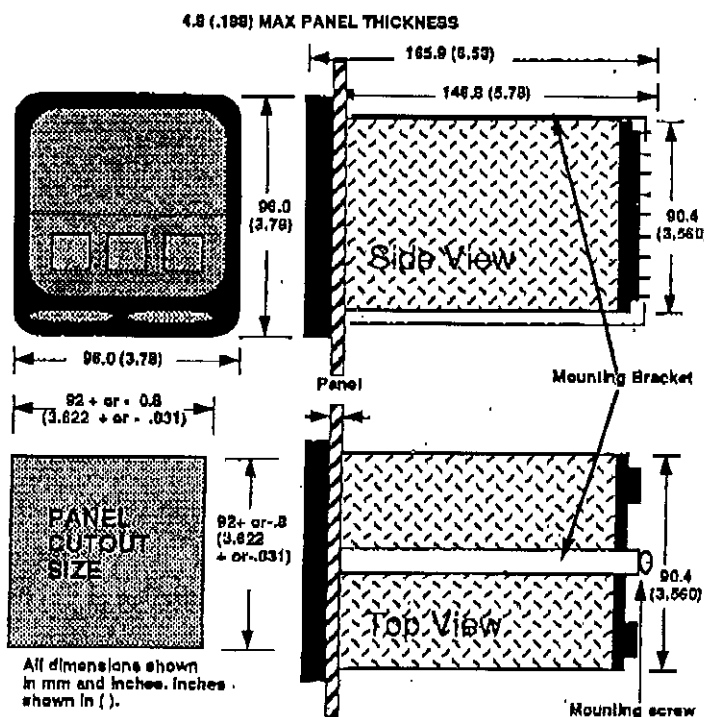

Preparation for Wiring 2.2

2.2.1 WIRING GUIDELINES

Electrical noise is a phenomenon typical of industrial environments. The following are guidelines that must be followed to minimize the effect of noise upon any instrumentation.

2.2.1.1 INSTALLATION CONSIDERATIONS

Listed below are some of the common sources of electrical noise in the industrial environment:

- Ignition Transformers
- Arc Welders
- Mechanical contact relay(s)
- Solenoids

Before using any instrument near the devices listed, the instructions below should be followed:

1. If the instrument is to be mounted in the same panel as any of the listed devices, separate them by the largest distance possible. For maximum electrical noise reduction, the noise generating devices should be mounted in a separate enclosure.
2. If possible, eliminate mechanical contact relay(s) and replace with solid state relays. If a mechanical relay being powered by an instrument output device cannot be replaced, a solid state relay can be used to isolate the instrument.
3. A separate isolation transformer to feed only instrumentation should be considered. The transformer can isolate the instrument from noise found on the AC power input.
4. If the instrument is being installed on existing equipment, the wiring in the area should be checked to insure that good wiring practices have been followed.

2.2.1.2 AC POWER WIRING

Earth Ground

The instrument includes noise suppression components that require an earth ground connection to function. To verify that a good earth ground is being attached, make a resistance check from the instrument chassis to the nearest metal water pipe or proven earth ground. This reading should not exceed 100 ohms. Use a 12 gauge (or heavier) insulated stranded wire.

Neutral (For 115VAC)

It is good practice to assure that the AC neutral is at or near ground potential. To verify this, a voltmeter check between neutral and ground should be done. On the AC range, the reading should not be more than 50 millivolts. If it is greater than this amount, the secondary of this AC transformer supplying the instrument should be checked by an electrician. A proper neutral will help ensure maximum performance from the instrument.

2.2.1.3 WIRE ISOLATION

Four voltage levels of input and output wiring may be used with the unit:

- Analog input or output (i.e. thermocouple, RTD, VDC, mVDC or mADC)
- SPST Relays
- SSR driver outputs
- AC power

The only wires that should be run together are those of the same category. If they need to be run parallel with any of the other lines, maintain a minimum 6 inch space between the wires. If wires must cross each other, do so at 90 degrees. This will minimize the contact with each other and reduces "cross talk" "Cross talk" is due to the EMF (electro Magnetic Flux) emitted by a wire as current passes through it. This EMF can be picked up by other wires running in the same bundle or conduit.



In applications where a High Voltage Transformer is used, (i.e. ignition systems) the secondary of the transformer should be isolated from all other cables.

This Instrument has been designed to operate in noisy environments, however, in some cases even with proper wiring it may be necessary to suppress the noise at its source.

2.2.1.4 USE OF SHIELDED CABLE

Shielded cable helps eliminate electrical noise being induced on the wires. All analog signals should be run with shielded cable. Connection lead length should be kept as short as possible, keeping the wires protected by the shielding. The shield should be grounded at one end only. The preferred grounding location is the sensor, transmitter or transducer.

2.2.1.5 NOISE SUPPRESSION AT THE SOURCE

Usually when good wiring practices are followed no further noise protection is necessary. Sometimes in severe electrical environments, the amount of noise is so great that it has to be suppressed at the source. Many manufacturers of relays, contactors, etc. supply "surge suppressors" which mount on the noise source.

For those devices that do not have surge suppressors supplied, RC (resistance-capacitance) networks and/or MOV (metal oxide varistors) may be added.

Inductive Coils - MOV's are recommended for transient suppression in inductive coils connected in parallel and as close a possible to the coil. See Figure 2-2. Additional protection may be provided by adding an RC network across the MOV.

FIGURE 2-2

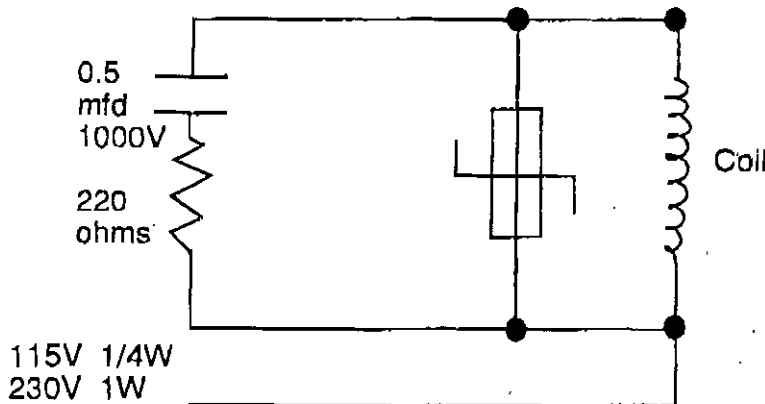

(Continued on next page)

PAGE 10

Contacts - Arcing may occur across contacts when the contact opens and closes. This results in electrical noise as well as damage to the contacts. Connecting a RC network properly sized can eliminate this arc.

For circuits up to 3 amps, a combination of a 47 ohm resistor and 0.1 microfarad capacitor (1000 volts) is recommended. For circuits from 3 to 5 amps, connect 2 of these in parallel. See Figure 2-3.

FIGURE 2-3

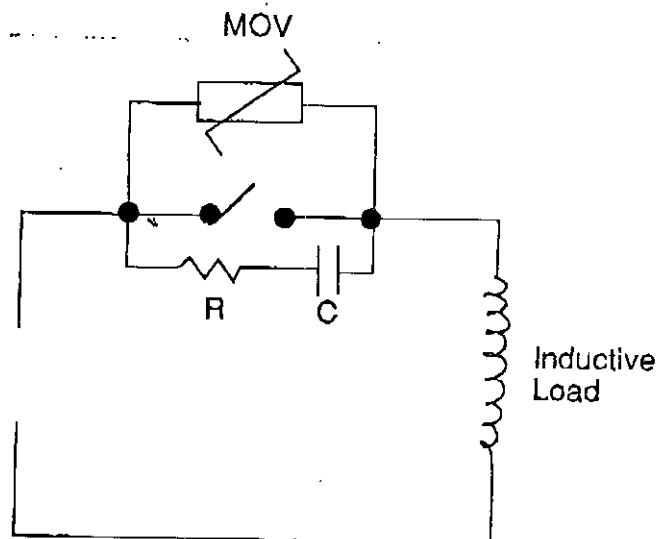

2.2.2 SENSOR PLACEMENT (Thermocouple or RTD)

Two wire RTD's should be used only with lead lengths less than 10 feet.

If the temperature probe is to be subjected to corrosive or abrasive conditions, it should be protected by the appropriate thermowell. The probe should be positioned to reflect true process temperature:

- In liquid media - the most agitated area.
- In air - the best circulated area

THERMOCOUPLE LEAD RESISTANCE

Thermocouple lead length can affect instrument since the size (gauge) and the length of the wire affect lead resistance.

To determine the temperature error resulting from the lead length resistance, use the following equation:

$T_{err} = TLe * L$ where; TLe = value from appropriate table below
L = length of leadwire in thousands of feet.

TABLE 1

Temperature error in °C per 1000 feet of Leadwire									
AWG No.	Thermocouple Type:								
	J	K	T	R	S	E	B	N	C
10	.34	.85	.38	1.02	1.06	.58	7.00	1.47	1.26
12	.54	1.34	.61	1.65	1.65	.91	11.00	2.34	2.03
14	.87	2.15	.97	2.67	2.65	1.46	17.50	3.72	3.19
16	1.37	3.38	1.54	4.15	4.18	2.30	27.75	5.91	5.05
18	2.22	5.50	2.50	6.76	6.82	3.73	44.25	9.40	8.13
20	3.57	8.62	3.92	10.80	10.88	5.89	70.50	14.94	12.91
24	8.78	21.91	9.91	27.16	27.29	14.83	178.25	37.80	32.64

TABLE 2

Temperature Error in °F per 1000 feet of Leadwire									
AWG No.	Thermocouple Type:								
	J	K	T	R	S	E	B	N	C
10	.61	1.54	.69	1.84	1.91	1.04	12.80	2.65	2.27
12	.97	2.41	1.09	2.97	2.96	1.64	19.80	4.21	3.66
14	1.57	3.86	1.75	4.81	4.76	2.63	31.50	6.69	5.74
16	2.47	6.09	2.77	7.47	7.52	4.14	49.95	10.64	9.10
18	4.00	9.90	4.50	12.17	12.28	6.72	79.95	10.64	9.10
20	6.43	15.51	7.06	19.43	19.59	10.61	126.90	26.89	23.24
24	15.80	39.44	17.83	48.89	49.13	26.70	320.85	68.03	58.75

Example:

A 1/4 Din unit is to be located in a control room 660 feet away from the process. Using 16 AWG, type J thermocouple, how much error is induced?

$T_{err} = TLe * L$
TLe = 2.47 (°F/1000 ft) from Table 2

$T_{err} = 2.47 (°F/1000 ft) * 660 ft$

$T_{err} = 1.6 °F$

PAGE 12

RTD LEAD RESISTANCE

RTD lead length can affect instrument accuracy, since the size (gauge) and length of the wire affect lead resistance.

To determine the temperature error resulting from the lead length resistance, use the following equation:

$$T_{err} = TLe \cdot L \quad \text{where; } TLe = \text{value from Table 3 if 3 wire RTD or Table 4 is 2 wire RTD}$$

$L = \text{length of lead wire in thousands of feet}$

TABLE 3 3 Wire RTD

AWG No.	Error °C	Error °F
10	± 0.04	± 0.07
12	± 0.07	± 0.11
14	± 0.10	± 0.18
16	± 0.16	± 0.29
18	± 0.26	± 0.46
20	± 0.41	± 0.73
24	± 0.65	± 1.17

TABLE 4 2 Wire RTD

AWG No.	Error °C	Error °F
10	± 5.32	± 9.31
12	± 9.31	± 14.6
14	± 13.3	± 23.9
16	± 21.3	± 38.6
18	± 34.6	± 61.2
20	± 54.5	± 97.1
24	± 86.5	± 155.6

Example:

An application uses 2000 feet of 18 AWG copper lead wire for a 3 wire RTD sensor. What is the worst case error due to this leadwire length?

$$T_{err} = TLe \cdot L$$

$TLe = \pm .46 \text{ (°F/1000 ft) from Table 3}$

$$T_{err} = \pm .46 \text{ (°F/1000 ft)} \cdot 2000 \text{ ft}$$

$$T_{err} = \pm 0.92 \text{°F}$$

FIGURE 2-4 WIRING LABEL

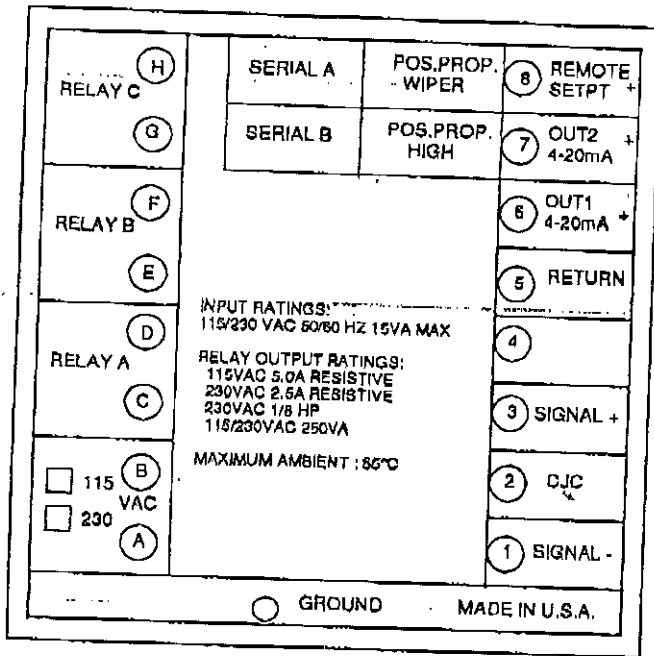

Input Connections 2.3

In general, all wiring connections are made to the instrument after it is installed. **Avoid electrical shock. AC power wiring must not be connected to the source distribution panel until all wiring connection procedures are completed.**

2.3.1 INPUT CONNECTIONS

FIGURE 2-5

AC Power

Connect 115 VAC hot and neutral to terminals B and A respectively as illustrated below. Connect 230 VAC as described below. Connect Earth ground to the ground screw as shown.

115 VAC INSTRUMENT VOLTAGE

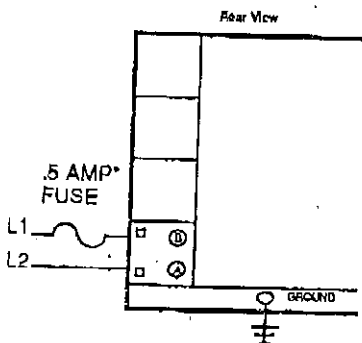

*Supplied by customer

230 VAC INSTRUMENT VOLTAGE

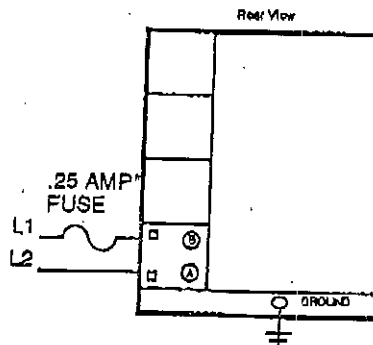

*Supplied by the customer

PAGE 14

FIGURE 2-6

Thermocouple (T/C) Input

Make thermocouple connections as illustrated below. Connect the positive leg of the thermocouple to terminal 3, and the negative to terminal 1. For industrial environments with comparatively high electrical noise levels, shielded thermocouples and extension wire are recommended. Be sure that the input conditioning jumpers are properly positioned for a thermocouple input. See Appendix A-2 (page 60) and A-3 (page 61, 62).

THERMOCOUPLE INPUT

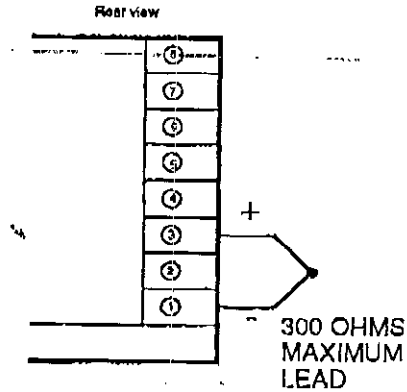
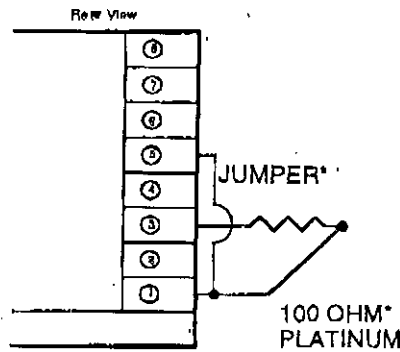

FIGURE 2-7

RTD Input

Make RTD connections as illustrated below. For a three wire RTD, connect the resistive leg of the RTD to terminal 3, and the common legs to terminal 1 and 5. For a two wire RTD, connect one wire to terminal 1 and the other wire to terminal 3 as shown below. A jumper wire supplied by the customer must be installed between terminals 1 and 5. Be sure that the input conditioning jumpers are properly positioned for an RTD input. See Appendix A-2 (page 60) and A-3 (page 61, 62).

2 WIRE RTD INPUT



*Supplied by customer

3 WIRE RTD INPUT

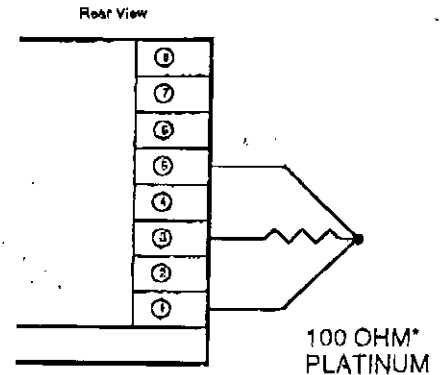

*Supplied by the customer

FIGURE 2-8

Volt, mV, mADC Input

Make volt, millivolt and milliamp connections as shown below. Terminal 3 is positive and terminal 1 is negative. Milliamp input requires a 250 ohm shunt resistor (supplied with the instrument) installed across the input terminals and by configuring the Instrument for either 0 to 5 or 1 to 5 VDC input. If desired, milliamp DC Input can be facilitated by installing an optional 2.5 ohm resistor across the input terminals and configuring the Instrument for either 0 to 50 or 10 to 50 mVDC. Be sure that the input conditioning jumpers are properly positioned for the input type selected. See Appendix A-2 (page 60) and A-3 (page 61, 62).

MILLIAMP DC INPUT

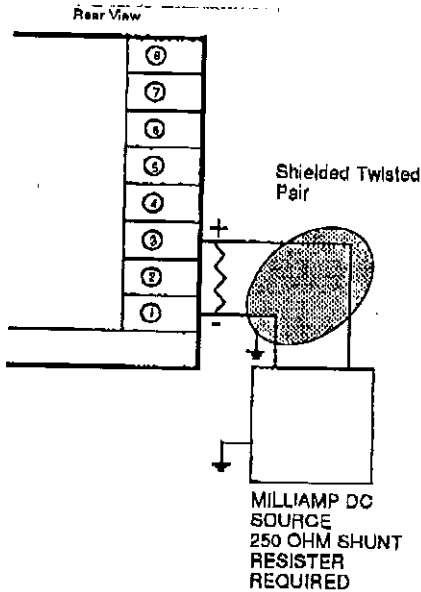

MILLIAMP DC INPUT

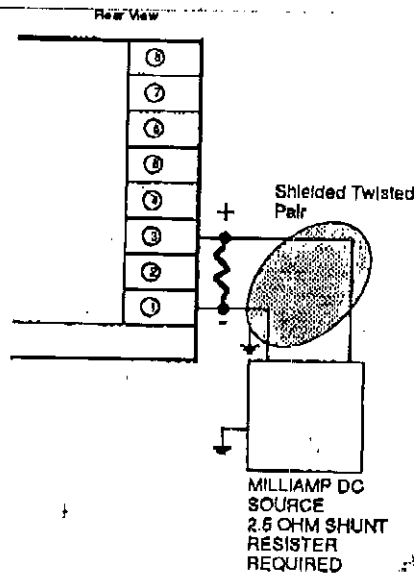

MILLIVOLT DC INPUT

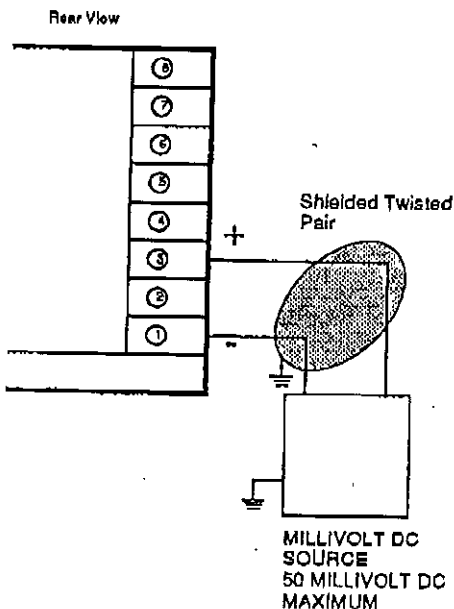

VOLT DC INPUT

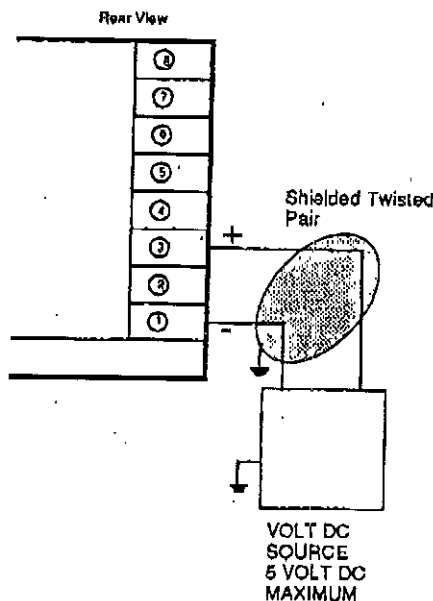

PAGE 16

FIGURE 2-9A

24 Volt Transmitter Power Supply (XP Option)

Make connections as shown below. Terminal 3 is positive (+) and terminal 1 is negative (-). Be sure the input conditioning jumpers are properly positioned for the input type selected. See Figure A-2 Processor Board, page 60, and Figure A-3 Option Board, page 61 or 62. Note the 250 ohm shunt resistor is not required.

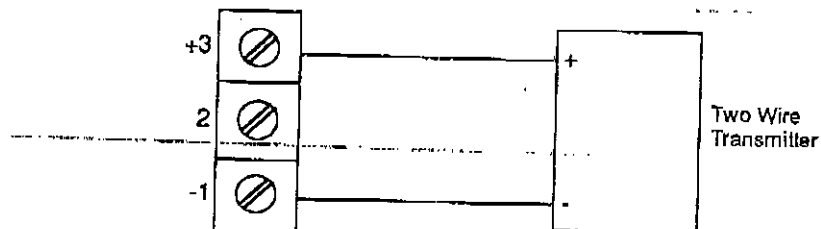

FIGURE 2-9B

24 Volt Power Supply (XA Option)

Make connections as shown below. Terminal G is positive (+) and terminal H is negative (-). Be sure the input conditioning jumpers are properly positioned. See Figure A-2 Processor Board, page 60 and Figure A-3 Option Board, page 61 or 62.

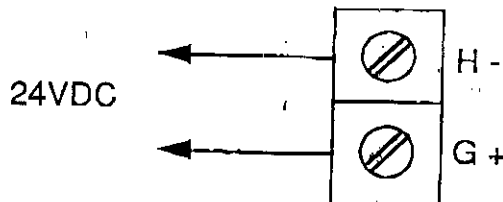
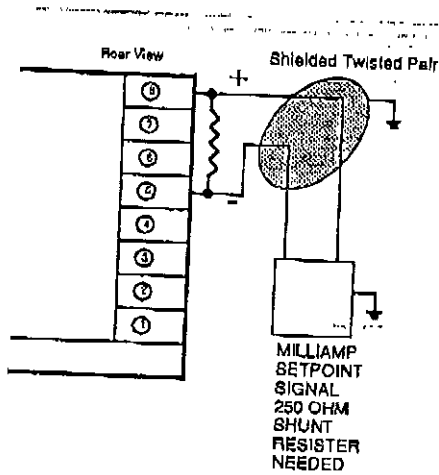

FIGURE 2-10

Remote Setpoint Input - VDC, mA DC and Potentiometer
 Input connections are illustrated below. Terminal 8 is positive and terminal 5 is negative.
 The remote setpoint input can be configured for either 0 to 5VDC or 1 to 5 VDC input. Make
 sure that the voltage input matches the voltage configuration selected in the Program mode.
 For mA inputs, a 250 ohm shunt resistor must be installed between terminals 5 and 8. For
 remote setpoint using a potentiometer, JU1 on options board must be in MM/PP (see page
 61, 62).

CURRENT DC REMOTE SETPOINT



VOLT DC REMOTE SETPOINT

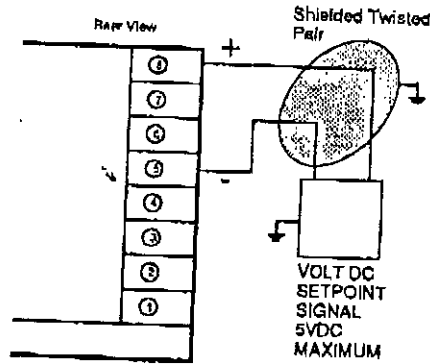

POTENTIOMETER

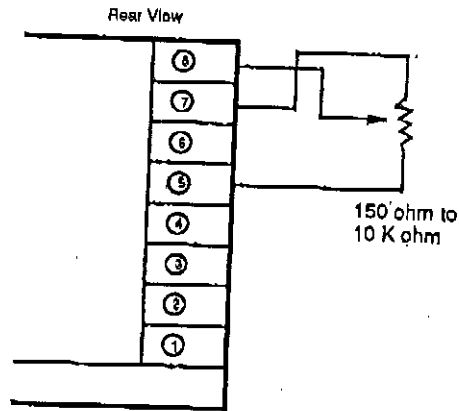

PAGE 18

FIGURE 2-11

Remote Digital Communications RS 485 Terminals 7 & 8

If the communications network continues on to other units, connect the shields together, but not to the instrument. A terminating resistor should be installed at the terminals of the last instrument in the loop. The shield should be grounded at the computer or the converter box, if used. See the Protocol Manual (Form 2878) for more details on the use of the digital communications option.

DIGITAL COMMUNICATIONS CONNECTIONS - TERMINALS 7 & 8

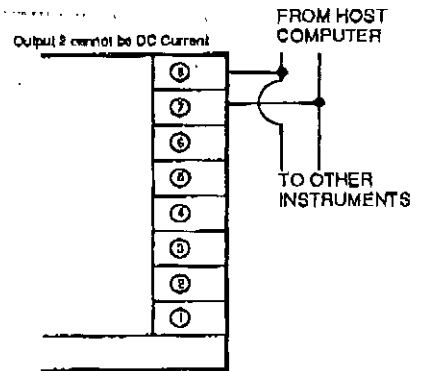

Output Connections 2.4

FIGURE 2-12

Relay Output

Connections are made to relay A as illustrated below. Connect relay(s) B & C (if present) in the same manner. Relay contacts are rated at 5 amp Resistive load 115 VAC.

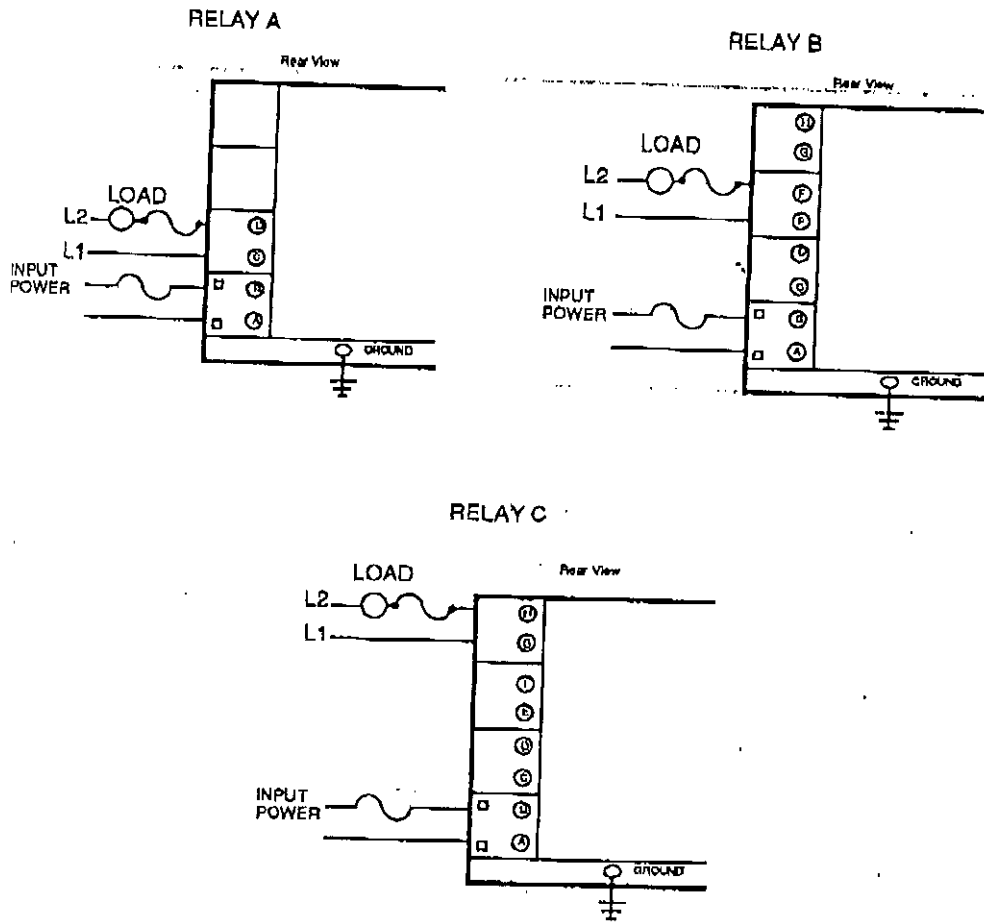

FIGURE 2-13

SSR Driver Output

Connections are made to the solid state relay driver output located in the Relay A position as shown. The solid state relay driver is a 5 VDC current sink output type. Connect the solid state relay driver(s) in the Relay B and C position (if present) in the same manner.

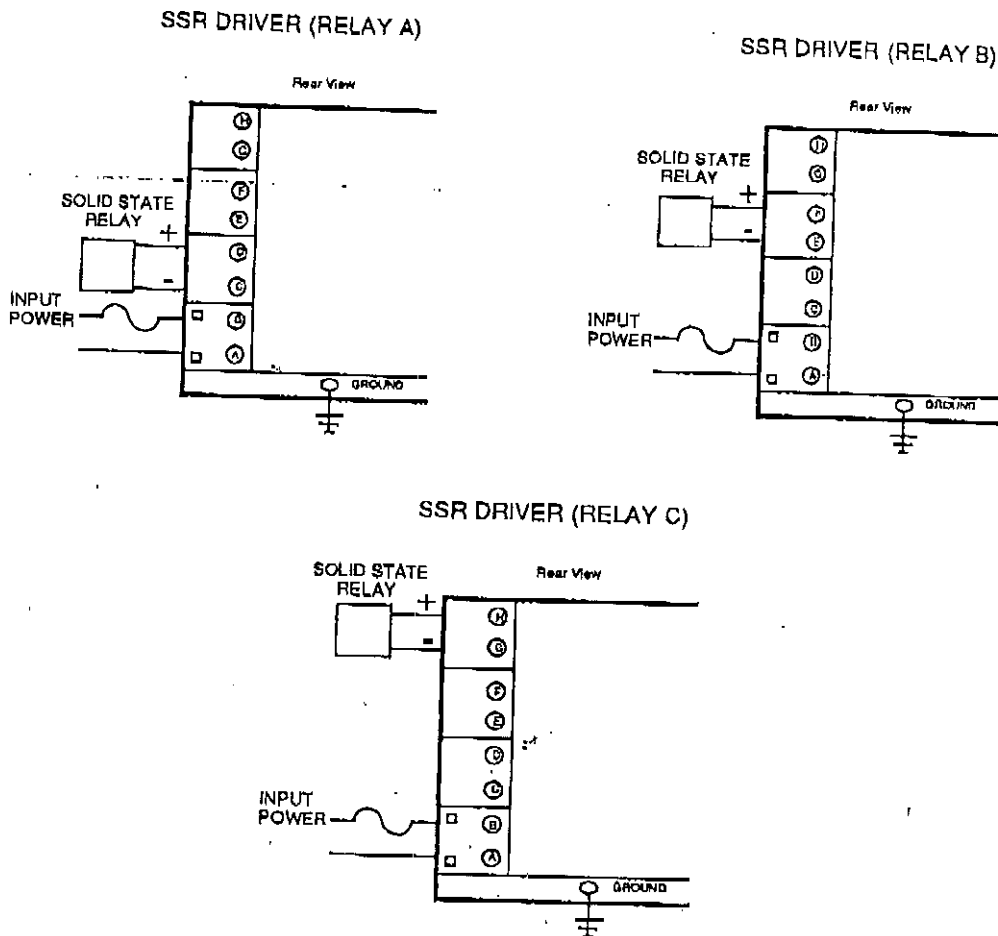

FIGURE 2-14

mADC Output

Connections are made for current outputs 1 or 2 as shown below. Connect the positive lead to terminal 6 for Output 1 or terminal 7 for Output 2, the negative leads connect to terminal 5. Current outputs will operate up to 650 ohms maximum load. The current output(s) are 4 - 20 mADC. With the EA option, they can be selected for either 4-20 or 0-20 mADC.

DC CURRENT OUTPUT 1

DC CURRENT OUTPUT 2

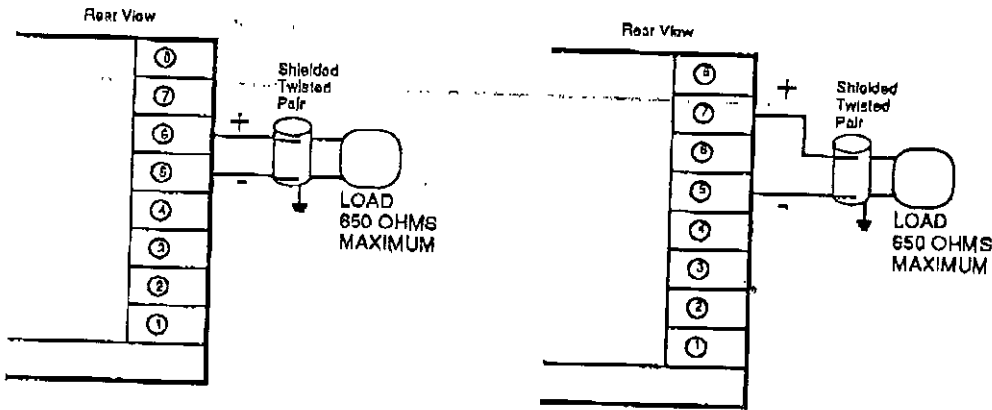
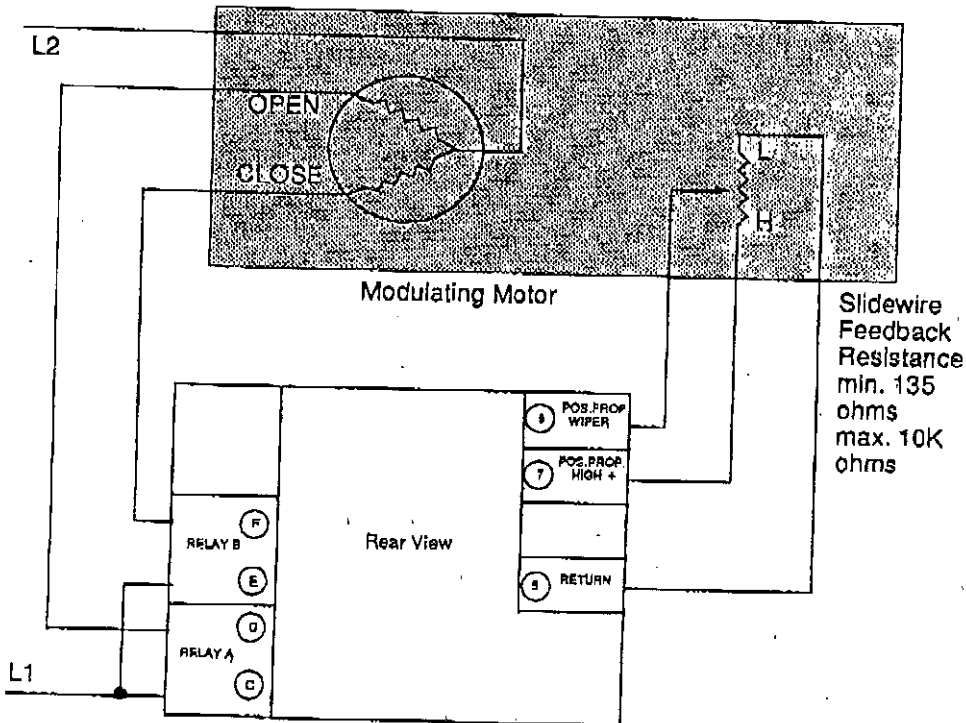

FIGURE 2-15

Position Proportioning Output

The relay and slidewire feedback connections are made as illustrated below. The relay assigned to Output 1 will be used to drive the motor in the open direction and the relay assigned to Output 2 will be used to drive the motor in the closed direction. The minimum slidewire feedback resistance is 135 ohms, the maximum resistance is 10K ohms.



Configuration and Operation 3.1

3.1.1 POWER UP PROCEDURE

Verify all electrical connections have been properly made before applying power to the instrument.

If the instrument is being configured (set up) for the first time, it may be desirable to disconnect the controller output connections. The instrument will go into the Control mode following the power up sequence and the output(s) may turn on. During power up, the seven digit model number will be displayed. Next, the software revision level will be displayed, followed by the EPROM tab number. Instrument self test 1 through 3 will take place as they are displayed. After completion of the tests Ctrl will be displayed for 3 seconds. At this time another mode of operation may be selected by pressing the SCROLL key.

3.1.2 CONFIGURATION PROCEDURE

Parameter selections and data entry are made via the front keypad. To ease configuration and operation, the user selectable features have been divided into several sections (modes). Data and parameter entries are made by stepping through each mode and making an appropriate response or entry to each step as necessary for the application.

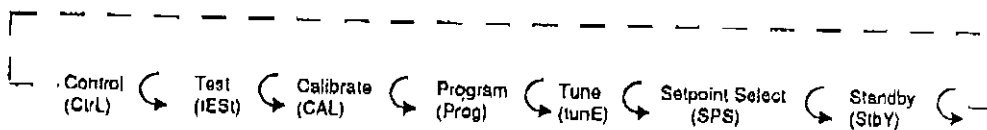

Operation Summary 3.2

3.2.1 KEYPAD OPERATION

SCROLL KEY

This key is used to:

1. Display enabled modes of operation
2. Display a mode parameter value
3. Advance display from a parameter value to the next parameter code
4. Exit some calibration/test functions
5. Used with other keys:
 - A. With UP key to view output percentages of proportional output(s)
 - B. With DOWN key
 1. On power up to alter model number
 2. Enter calibration/test functions

**UP KEY**

This key is used to:

1. Increase displayed parameter value
2. View setpoint (press and release)
3. Increase setpoint (press and hold)
4. With a parameter code displayed
 - A. Press once to exit mode
 - B. Press twice to enter Control mode
5. Used with other keys
 - A. In Control mode with SCROLL key to view output percentages of proportional output(s).
 - B. With DOWN Key
 1. On power up resets instrument
 2. Lamp test (press and release)
 3. Enter Enable Mode (press and hold)

DOWN KEY

This key is used to:

1. Decrease displayed parameter value
2. View setpoint (press and release)
3. Decrease setpoint (press and hold)
4. Enter modes
5. While in a mode, will sequence the parameter codes
6. Used with other keys
 - A. With SCROLL key
 1. On power up to alter model number
 2. Enter calibration/test functions
 - B. With UP key
 1. On power up resets instrument
 2. Lamp test (press and release)
 3. Enter enable mode (press and hold)

3.2.2 CONFIGURATION DISPLAYS

During configuration, the display shows the parameter codes and values. During operation, the display is used to indicate process value, setpoint, deviation from setpoint, proportional output percentage, etc.

3.2.3 MODE SELECTION

If the instrument is in the Control mode, repeated depressions of the SCROLL key will cause the instrument to display the code corresponding to each mode that is enabled. To enter a mode, with the mode displayed, depress the DOWN key. Entry into any mode except the Control, Tune and Enable modes will cause the output(s) to turn off.

Note: If Display Select = 5 (Setpoint Continuously) It takes two depressions of the SCROLL key to exit Control.

Configuration Summary 3.3

All configurable parameters are provided in Tables 3-1 thru 3-3 on the following pages. These tables illustrate the display sequence, parameter adjustment and factory setting for each step.

The instrument is provided with a "time-out" feature. If the instrument is in any mode, other than the Control mode, and no keypad activity takes place for 30 seconds, the mode will be exited automatically. The instrument will then display the code for the respective mode. If a mode code is displayed for five seconds with no key stroke actively the "time-out" will cause the instrument to return to the Control mode of operation.

3.3.1 ENABLE MODE CONFIGURATION

The Enable Mode provides a means of enabling or disabling access to setpoint changes and each of the non-control modes. In the Enable mode, each mode except Control, will be displayed. Either "on" (enabled) or "oFF" (disabled) may be selected. See Table 3-1 (below) for the Enable mode procedure. For additional security, the Enable mode may be locked out by using a hardware jumper, JU 2, located on the Processor board. See Appendix A-2 (page 59).

3.3.2 PROGRAM MODE CONFIGURATION

The Program mode is used to configure or re-configure the instrument. All possible parameters are illustrated in Table 3-2 (page 29) for illustrative purposes. Only those parameters that are applicable to the hardware options chosen or to previous parameter selections will be displayed.

3.3.3 TUNE MODE CONFIGURATION

The Tune mode is used to adjust the tuning parameters and the alarm setting needed for operation of the instrument.

TABLE 3-1 ENABLE MODE CONFIGURATION PROCEDURE

To enter the Enable mode depress and hold the UP and DOWN keys. All display lamps will light, after ten seconds the display will read EnAb. If EnAb does not appear, check the position of the Enable mode jumper, JU 2, located on the Processor board (See Appendix A-2, page 60). Release the keys and the display will then change to EtSt. Depress the SCROLL key to review the state (on or off) of the mode. Use the UP key to enable a mode that is off. Use the DOWN key to disable a mode that is on. When all selections have been made, to exit the Enable mode depress the UP key with a mode code displayed EtSt, ECAL, etc.

STEP	DESCRIPTION	DISPLAY CODE	AVAILABLE SETTINGS	FACTORY SETTING	YOUR SETTING
1	Test Mode	EtSt	on or oFF	oFF	
2	Calibration Mode	ECAL	on or oFF	oFF	
3	Program Mode	EPro	on or oFF	on	
4	Tune Mode	Etun	on or oFF	on	
5	Standby Mode	ESby	on or oFF	on	
6	Setpoint Select	ESPS	on or oFF	oFF	
7	Setpoint Changes	ESPC	on or oFF	on	

ENABLE MODE FLOW CHART

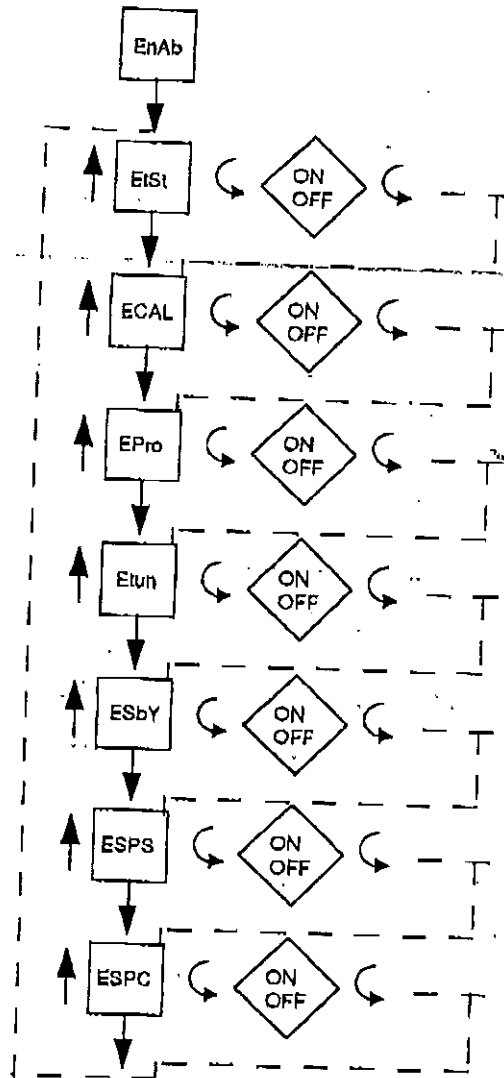



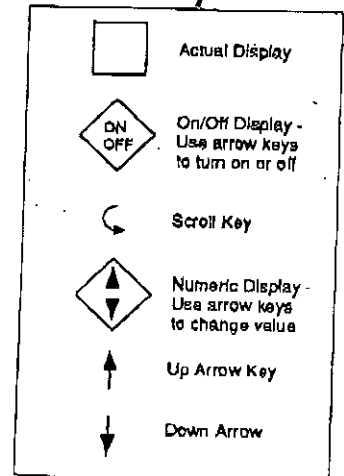

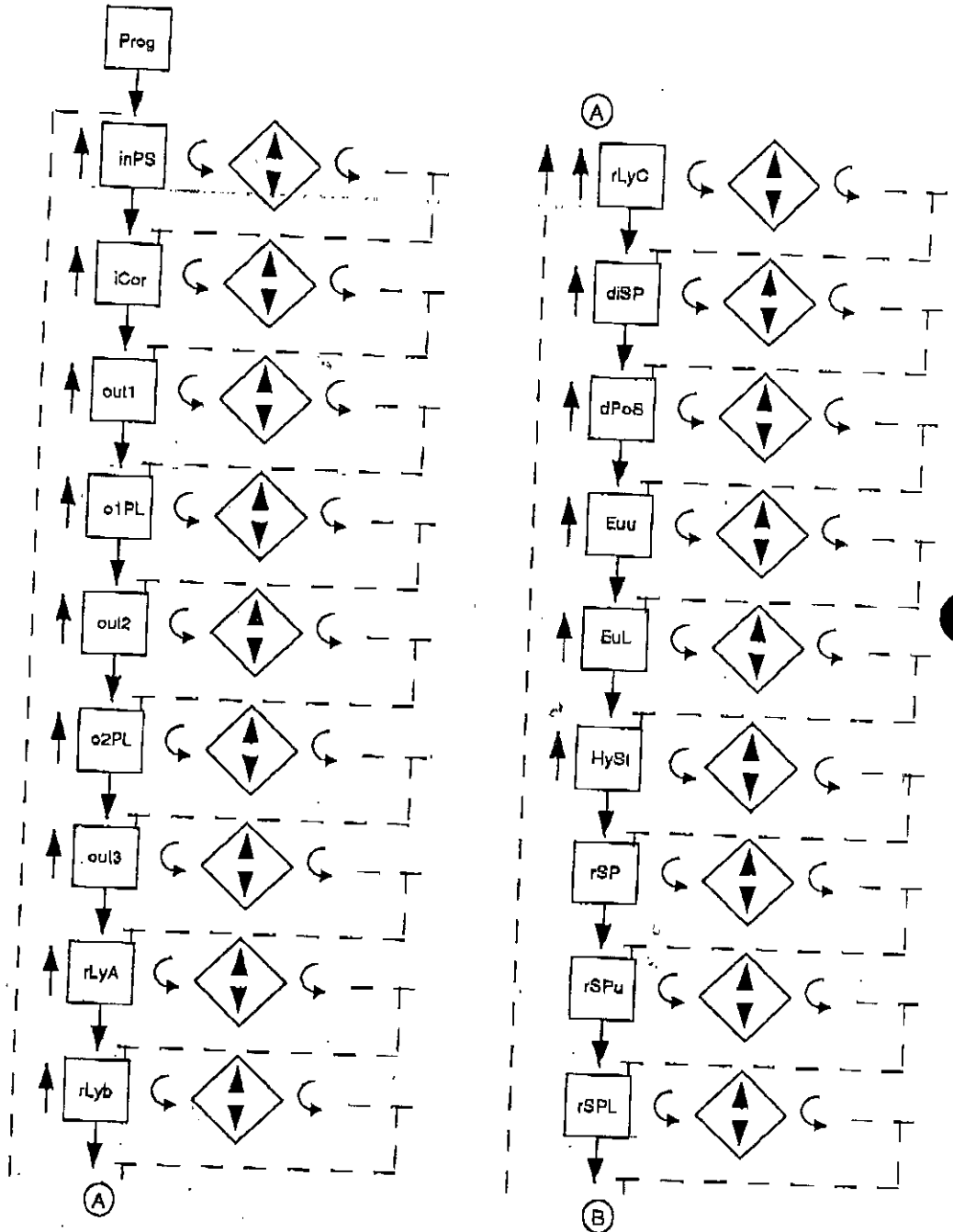

Key



PROGRAM MODE



Key

-  Actual Display
-  On/Off Display - Use arrow keys to turn on or off
-  Scroll Key
-  Numeric Display - Use arrow keys to change value
-  Up Arrow Key
-  Down Arrow

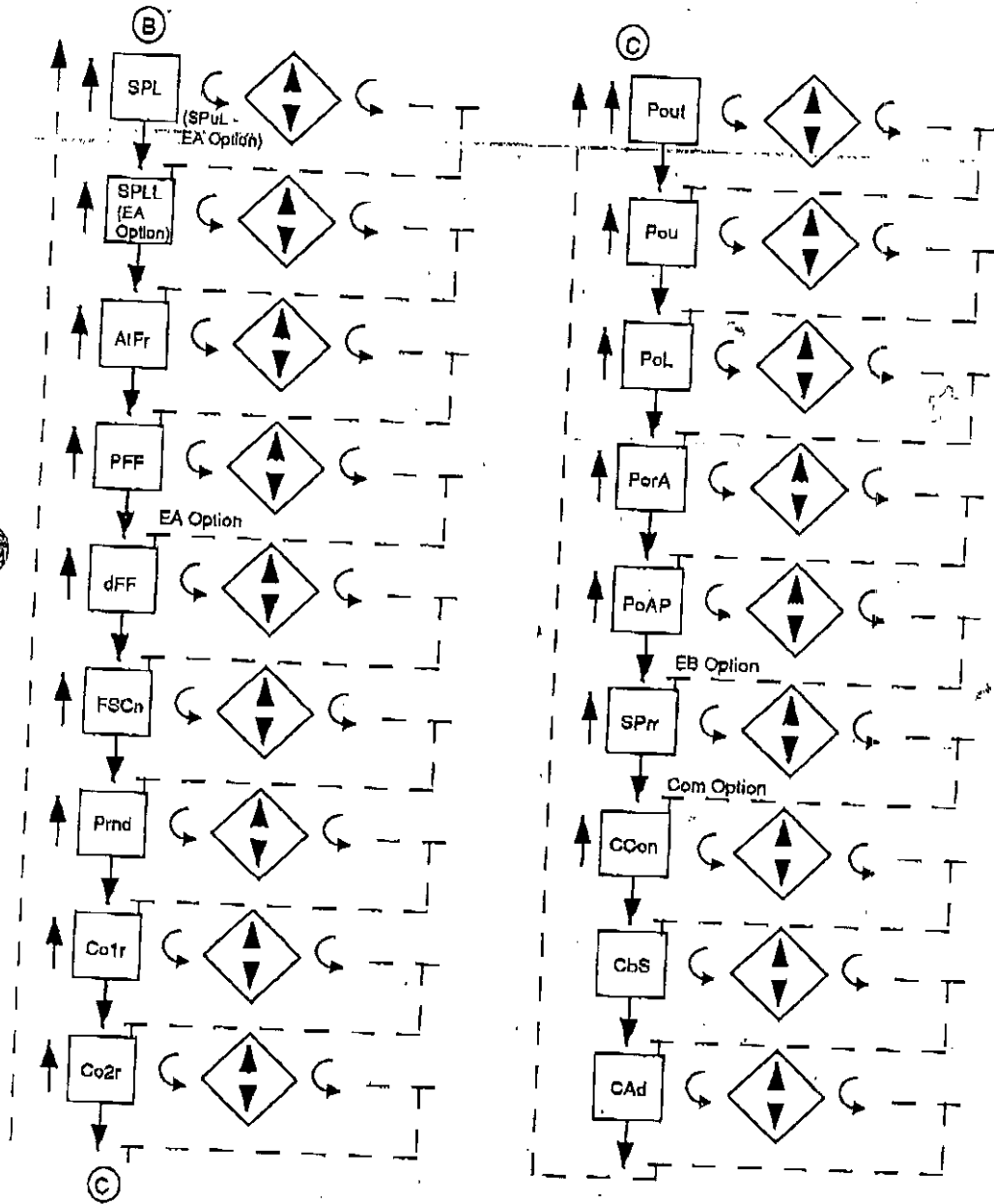

TABLE 3-2 PROGRAM MODE CONFIGURATION PROCEDURE

Press and release the SCROLL key until Prog is displayed. Use the DOWN key to enter the Program mode. Depress and release the SCROLL key to advance the display through the parameters and their values. Use the UP and DOWN keys to adjust the parameter values. After adjusting a parameter, depress the SCROLL key to proceed to the next parameter. After all selections have been made, depress the UP key with a parameter code in the display (not a setting) to exit the mode.

Note that parameter values are referred to in Degrees (°) and Engineering Units in the following tables. The input selection determines what the parameter values will be.

STEP	DESCRIPTION	DISPLAY CODE	AVAILABLE SETTINGS	FACTORY SETTING	YOUR SETTING
1	Input Select	InPS	0 = J °C Thermocouples 1 = J °F 2 = K °C 3 = K °F 4 = T °C 5 = T °F 6 = R °C 7 = R °F 8 = S °C 9 = S °F 10 = E °C 11 = E °F 12 = B °C 13 = B °F 14 = N °C 15 = N °F 16 = C °C 17 = C °F 20 = RTD °C 21 = RTD °F 30 = 0 to 5VDC / 0 to 20mA 31 = 1 to 5VDC / 4 to 20mA 32 = 0 to 50mVDC 33 = 10 to 50mVDC 34 = 0 to 25mVDC	7	
2	Input Correction	ICor	-300° to 300°/Units	0	
3	Output 1	out1	1 = On-Off Direct (Cooling) 2 = On-Off Reverse (Heating) 3 = Time Proportioning - Direct (Cooling) 4 = Time Proportioning - Reverse (Heating) 5 = Current Proportioning - Direct (Cooling) 6 = Current proportioning - Reverse (Heating) 7 = Position Proportioning Reverse (Open) 8 = On-Off Latched * Direct 9 = On-Off Latched * Reverse * Relays latch in the open position	2	
4	Output 1 Percent Limit	o1PL	0 to 100%	100	

STEP	DESCRIPTION	DISPLAY CODE	AVAILABLE SETTINGS	FACTORY SETTING	YOUR SETTING
5	Output 2	out2	0 = None Position Proportioning Direct (Close) 1 = On-Off Direct (Cooling) 2 = On-Off Reverse (Heating) 3 = Time Proportioning-Direct (Cooling) 4 = Time Proportioning-Reverse (Heating) 5 = Current Proportioning-Direct (Cooling) 6 = Current Proportioning-Reverse (Heating) 7 = Position Proportioning Reverse (Close)	0	
6	Output 2 Percent Limit	o2PL	0 to 100%	100	
7	Output 3	out3	0 = None 1 = Process Alarm-Direct 2 = Process Alarm-Reverse 3 = Deviation Alarm-Direct 4 = Deviation Alarm-Reverse 5 = Deviation Band Alarm-Open within band 6 = Deviation Band Alarm-Closed within band	0	
8	Relay A Assignment	rLyA	0 = Not assigned 1 = Assigned to Output 1 2 = Assigned to Output 2 3 = Assigned to Output 3 4 = % Output Relay Actuation (EA Option)	1	
9	Relay B Assignment	rLyb	Same selection as Relay A	2	
10	Relay C Assignment	rLyC	Same selection as Relay A	3	
11	Display Select	diSP	1 = Process Value (PV) 2 = PV and Setpoint 3 = Deviation 4 = Deviation and Setpoint 5 = Setpoint	1	
12	Decimal Position	dPoS	0 or 1 for T/C and RTD Input 0 to 3 for vol/mV Input	0	
13	Engineering units Upper Value	Euu	-9999 to 9999	1000	
14	Engineering units Lower Value	EuL	-9999 to 9999	0	
15	Hysteresis for On/Off Outputs	HysT	0 to 300%/Units (width of hysteresis band)	3	
16	Remote Setpoint	rSP	0 = None 1 = 1 to 5 Volts DC 2 = 0 to 5 Volts DC 3 = Contact Closure Sensing for SP=PV (EA Option)	0	

PAGE 30

STEP	DESCRIPTION	DISPLAY CODE	AVAILABLE SETTINGS	FACTORY SETTING	YOUR SETTING
17	Remote Setpoint Upper Value	rSPu	-9999 to 9999°/Units	1400*	
18	Remote Setpoint Lower Value	rSPL	-9999 to 9999°/Units	0	
19	Setpoint Upper Limit	SPL (SPuL - EA Option)	-9999 to 9999°/Units	1400*	
20	Setpoint Lower Limit	SPLL (EA Option) ± 9999		0	
21	Automatic Transfer	AtFr	0 = No automatic transfer 1 = Transfer when PV goes below setpoint 2 = Transfer when PV goes above setpoint	0	
22	Process Filter Factor	PPF	1 to 20 (# of scans averaged) 1 = no filtering	1	
23	Display Filter Factor	dFF	1 to 20 (# of scans averaged) 1 = No Filtering	1	

* Whenever INPS is changed, the parameter is set to the upper limit of advertised span.

Extended Features Software Options (EA)

24	Fast Scan	FSCn	0 = Standard Scan - 1 scans/second 1 = Fast Scan - 3 scans/second	0	
25	Process Rounding	Prnd	1 to 100 degrees/units 1, 0.1, 0.01, 0.001 = no rounding, depending on dPoS	1	
26	Current Output 1	Co1r	0 = 0 to 20mADC 1 = 4 to 20mADC	1	
27	Current Output 2	Co2r	0 = 0 to 20mADC 1 = 4 to 20mADC	1	
28	Process Output	Pout	0 = Not selected 1 = Process Assigned to Current Output 1 2 = Process Assigned to Current Output 2 3 = Setpoint Assigned to Current Output 1 4 = Setpoint Assigned to Current Output 2	0	
29	Process/Setpoint Output Upper Value	Pou	-9999 to 9999 degrees/units	2000	
30	Process/Setpoint Output Lower Value	Pol	-9999 to 9999 degrees/units	0	

STEP	DESCRIPTION	DISPLAY CODE	AVAILABLE SETTINGS	FACTORY SETTING	YOUR SETTING
31	Percent Output Relay Actuation	PorA	0 = None 1 = Based upon proportional Output 1 On when process is above PoAP 2 = Based upon proportional Output 1 On when process is below PoAP 3 = Based upon proportional Output 2 On when process is above PoAP 4 = Based upon proportional Output 2 On when process is below PoAP	0	
32	Percent Output Actuation Point	PoAP	0 to 100 percent The relay assigned to "Special Actuation 1" will activate per PorA at the percentage output specified by PoAP.	95	

Extended Features Software Options (EB)

33	Setpoint Ramp Rate	SPrr	0 to 100%/Units per minute 0 = not used	0.0	
----	--------------------	------	--	-----	--

Communication Parameters 33-35 are optional

34	Communications Configuration	CCon	0 = Off 1 = Monitor Mode (Read Only) 2 = Normal Mode (Read & Write) 3 = Total Access with Limit Checking 4 = Total Access without Limit Checking	0	
35	Communications Bit Rate	CbS	1 = 300 bit rate 2 = 600 bit rate 3 = 1200 bit rate 4 = 2400 bit rate 5 = 4800 bit rate 6 = 9600 bit rate	6	
36	Communications Address	CAd	0 to 99	0	

TUNE MODE FLOW CHART

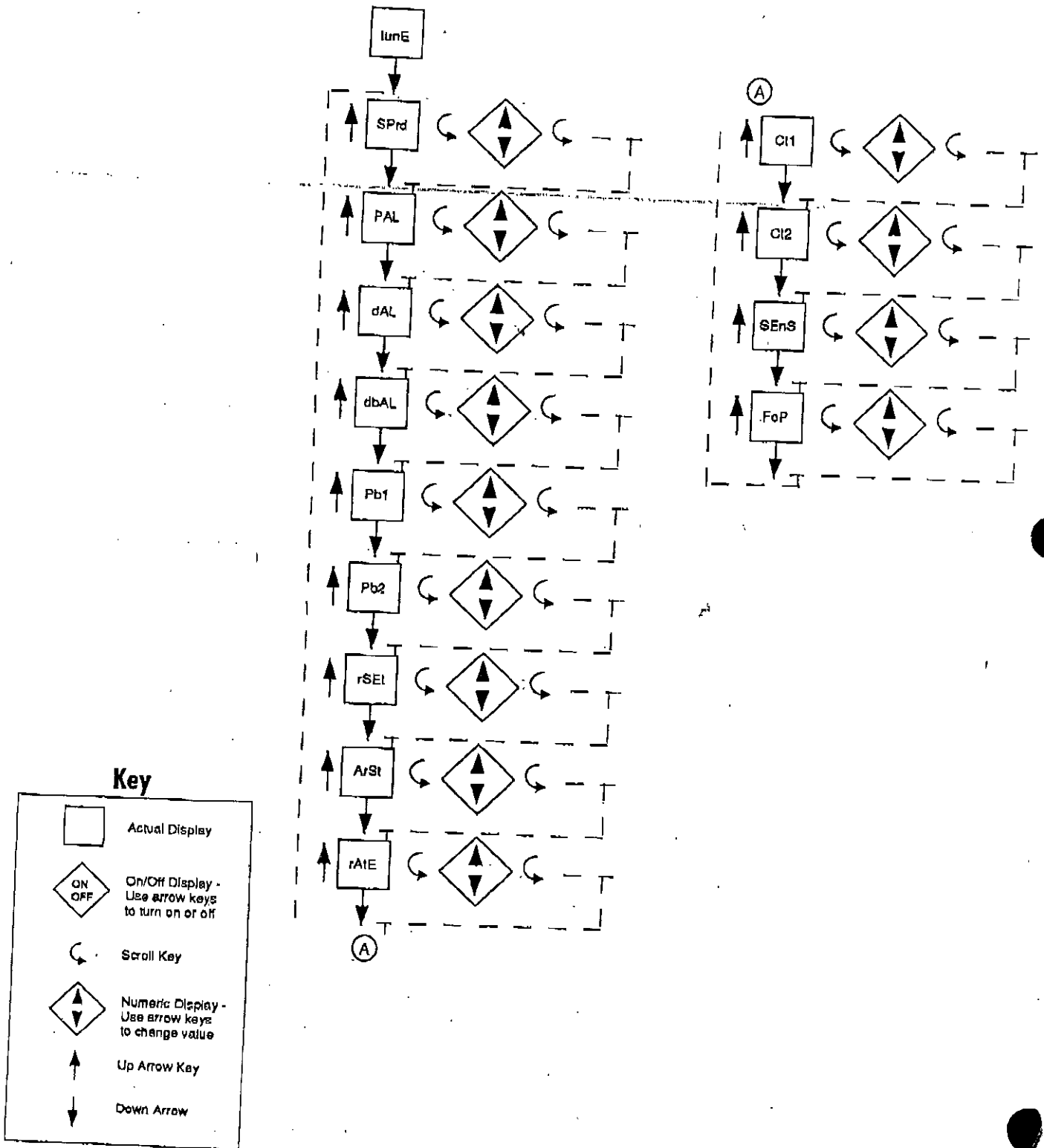



TABLE 3-3 TUNE MODE CONFIGURATION PROCEDURE

Depress the SCROLL key until tunE is displayed. Use the DOWN key to enter the Tune mode. Depress and release the SCROLL key to sequence through the parameters and their values. Use the UP and DOWN keys to adjust the values. After adjusting a parameter, depress the SCROLL key to proceed to the next parameter. After all selections have been made, depress the UP key with a parameter code displayed (not a setting) to exit the mode.

STEP	DESCRIPTION	DISPLAY CODE	AVAILABLE SETTINGS	FACTORY SETTING	YOUR SETTING
1	Spread (Second Output Position)	SPrd	-1000 to 1000 %/units	0	
2	Process Alarm	PAL	-9999 to 9999 %/units	0	
3	Deviation Alarm	dAL	-3000 to 3000 %/units	0	
4	Deviation Band Alarm	dbAL	1 to 3000 %/units	1	
5	1st Output Proportional Band Width	Pb1	1 to 3000 %/units	100	
6	2nd Output Proportional Band Width	Pb2	1 to 3000 %/units	100	
7	Manual Reset	rSEt	-1500 to 1500 %/units	0	
8	Automatic Reset (Integral)	ArSt	0.0 to 100.0 repeats per minute	0.0	
9	Rate (Derivative)	rATE	0.0 to 10.0 minutes	0.0	
10	Cycle Time Output 1	CI1	1 to 240 seconds	30	
11	Cycle Time Output 2	CI2	1 to 240 seconds	30	
12	Position Prop. Sensitivity	SEnS	0.0 to 50.0 %	1.0	
13	First Output Position	FoP	-1000 to 1000 %/units	0	

Note: The Program, Tune and Enable Mode selections can be conveniently recorded on the Software Reference Sheet located in Appendix E (page 70).

Tune Mode Operation 3.4

Proportional output control may require the adjustment (tuning) of the PID and other related parameters. This provides a means for the instrument's control algorithm to be adjusted to meet specific application requirements.

3.4.1 SYSTEMATIC TUNING METHOD

1. Changes in tuning parameters should be made one at a time.
2. After making any changes in tuning parameters, a disturbance should be introduced into the process so that the process reaction may be observed. This process reaction, or recovery, will tell whether the tuning parameters provide the desired control. It is usually easiest to make a step change in setpoint to introduce this disturbance.
3. The change in setpoint, or disturbance, referenced above should be large enough to cause an observable deviation of process from setpoint. However, this change should not be so large that it will cause the controller output to proceed to either extreme limit.
4. Controller tuning for optimal control is not hard and fast, **BE PATIENT**. The process will take a certain amount of time to react to the setpoint changes during tuning. The amount of time depends upon the specific process, however, a period of 8 to 12 minutes should be allowed between changes. The important point to remember is to allow the process to react completely, do not rush through tuning of the controller. If the complete process reaction is not observed, optimum control may never be achieved.
5. Time Proportioning control output(s) require(s) the cycle time to be adjusted for the application. Short cycle times typically result in the most accurate process control, but will cause the quickest wear out of any mechanical components.
6. Leave all other tuning parameters (except for the alarm settings, if used) at the factory default settings. Obtain the best possible process reaction by adjusting the Proportional Bandwidth parameter. The setting that achieves the best response for the process should be left in the controller programming, and should be noted on the Software Reference Sheet in Appendix E (page 70).
7. If there are to be no setpoint or load changes in the process, the Proportional Band adjustment may be all that is necessary for proper control. If an offset still exists (the process does not settle out at setpoint with the best possible proportional band adjustment) Manual Reset may be added to eliminate this offset.
8. Auto Reset may be added to eliminate offsets and improve response to setpoint and load changes. Increase Auto Reset from 0 to 0.2 increments. Start with a small amount. Increase this increment if there is no apparent reaction. Remember to allow the process 8 to 12 minutes to react.
9. If necessary, Rate may be added. Rate is a dynamic tuning parameter. Rate may be required to compensate for process lags or to help inhibit reset windup when a large amount of Auto Reset (4 or 5 repeats per minute) is being used.
10. Controller tuning is not hard and fast. It may be necessary to adjust the tuning parameters over a period of time to obtain optimal control of the process.

3.4.2 ZIEGLER NICHOLS TUNING METHOD

This procedure has been determined empirically to yield 1/4 amplitude decay tuning parameters that are determined by watching the system in a sustained oscillation (curve C, page 36, the ultimate proportional band and ultimate time period) and then using these values from this sustained oscillation to calculate ideal parameters.

Determining Ultimate Proportional Band and Ultimate Time Period

1. Set Manual Reset rSet to 0.0, set ArSt to 0.0 and set rAtE to 0.0
2. Enter the Control mode of operation, observe the process reaction.
3. Set the Proportional Band (PB) at 100 and upset the process and observe the response. One easy method for imposing the upset is to move the setpoint for a few seconds and then return it to its original value.
4. Achieve a response curve similar to the sustained oscillation (curve C), this is the Ultimate Proportional Band (UPB) and Ultimate Time Period (UTP).
 - a) If the response curve from step 3 does not damp out, as in Curve A from the drawing, the PB is too low. The PB should be increased and step 3 repeated.
 - b) If the response in step 3 damped out, the PB is too high. The PB should be decreased and step 3 repeated.

These values obtained for Ultimate Proportional Band (UPB) and Ultimate Time Period (UTP) are used to calculate ideal P, PI, PD, PID tuning parameters using the following Ziegler-Nichols equations:

Proportional only control (P) -

$$P (Pb) = 2 \times UPB \text{ (degrees or units)}$$

Proportional plus automatic reset (PI)

$$P (Pb) = 2.2 \times UPB \text{ (degrees or units)}$$

$$I (ArSt) = 1.2 / UTP \text{ (repeats per minute)}$$

Proportional plus derivative (or rate) (PD) -

$$P (Pb) = 1.7 \times UPB \text{ (degrees or units)}$$

$$D (rAtE) = UTP / 8 \text{ (minutes)}$$

Proportional plus automatic reset plus derivative (PID)

$$P (Pb) = 1.7 \times UPB \text{ (degrees or units)}$$

$$I (ArSt) = 2 / UTP \text{ (repeats per minute)}$$

$$D (rAtE) = UTP / 8 \text{ (minutes)}$$

If an overdamped response is desired, multiply the proportional band by two.

PAGE 36

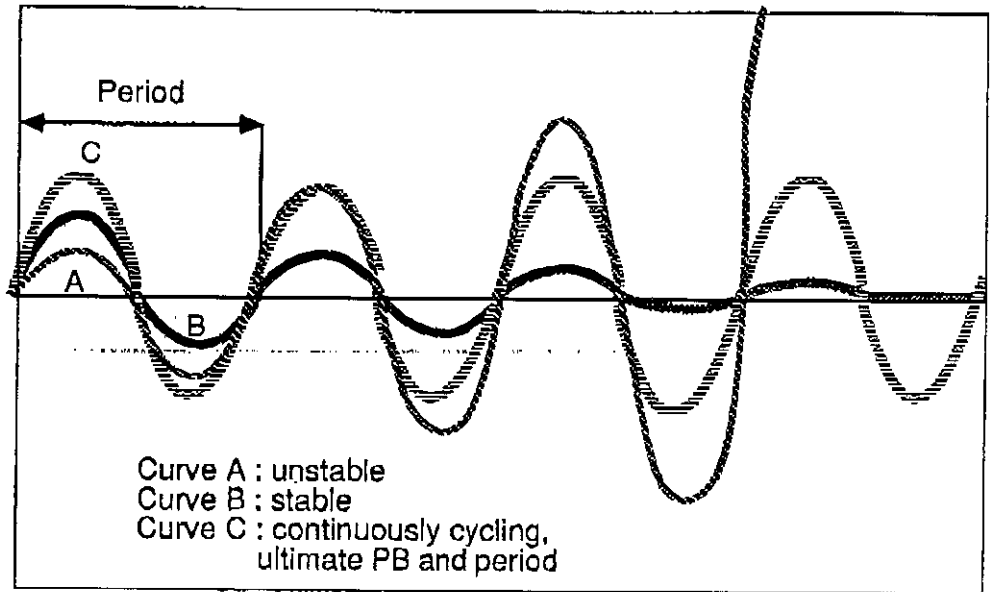

Control Capability 4.1

A variety of user programmable control features and capabilities are available including:

- On-Off Control
- Current Proportioning
- Alarm Functions
- Auto/Manual Switching
- Setpoint Adjustment
- Time Proportioning Control
- Position Proportioning Control
- Dual Output Control
- Automatic Transfer
- Process Re-transmission

The capabilities available in a specific unit are dependent upon the hardware options specified when the instrument is ordered. Refer to Appendix C (page 61) for the decoding of the instrument model number. Current proportioning control cannot be implemented if a current output was not ordered. Position proportioning cannot be implemented if two relays (Outputs 1 and 2) and the option have not been ordered. The available output types and quantity of each are as follows:

Type of Output	Quantity Available
• SPST mechanical relay output	Up to three
• SSR Driver	Up to three
• mADC current output	Up to two

The maximum number of SPST relay and/or SSR driver outputs available on a single instrument is three. Relay and SSR drivers may be assigned as either control or alarm outputs. The mADC current output(s) may be assigned control or process value retransmission output functions.

Control Responses 4.2

Each instrument may be configured to provide 3 mode proportional control. Proportional control is provided with Proportional Band, Integration, and Derivative responses.

Manual Reset is provided for use in lieu of, or in conjunction with automatic reset. A cycle time adjustment parameter is provided for use with each time proportioning control output.

Direct/Reverse

Operation of Outputs 4.3

Direct operation is typically used with cooling applications. On-Off direct output(s) will turn on when the process variable exceeds setpoint. Proportional direct output(s) will increase the percentage of output as the process value increases within the proportional band.

Reverse operation is typically used with heating applications. On-Off reverse output(s) will turn off when the process variable exceeds setpoint. Proportional reverse output(s) will decrease the percentage of output as the process value increases within the proportional band.

PAGE 38

On-Off Control / Latched On-Off 4.4

On-Off control can be implemented with SPST relay or SSR driver output(s). On-Off operation can be assigned to either or both Output 1 and 2. A hysteresis adjustment is provided for On-Off Outputs. This adjustment is in terms of degrees/engineering units and defines the bandwidth of the hysteresis. The hysteresis value straddles the setpoint. Relay chatter can be eliminated by proper adjustment of this parameter. When operating in On-Off control, the output(s) will turn on or off depending upon the setpoint, the process value, Tune mode selections, and the hysteresis adjustment.

Resetting of an On-Off latched output (out1 = 8 or 9) is accomplished by pressing the UP arrow. The relay will stay reset only if the condition is cleared.

Time Proportioning Control 4.5

Time Proportioning control can be implemented with a SPST relay or SSR driver. Time Proportioning control can be selected for Output 1 and/or Output 2, depending on hardware configuration. Time Proportioning control is accomplished by cycling the output on and off during a prescribed period of time when the process variable is within the proportional band.

Ex: Calculated output % = 40%; Cycle time adjustment = 20 seconds
 Output on time = $.4 \times 20 = 8$ seconds
 Output off time = $.6 \times 20 = 12$ seconds

When the unit is operating in the Control mode, the control algorithm determines the output % required to correct for any difference between the process value and the setpoint. The output calculation is affected by Tune mode parameter adjustments.

See Figure 4-1 (page 39) for proportional bandwidth effect on the output.

Current Proportioning Control 4.6

Current Proportioning control can be implemented on units provided with mA/DC current output(s). Current Proportioning control provides a 4 to 20mA/DC or 0 to 20mA/DC output in response to process value and setpoint. As with Time proportioning, the calculated output % for Current proportioning control is affected by the Tune mode parameter adjustments.

See Figure 4-1 (page 39) for proportional bandwidth effect on the output.

Position Proportioning Control 4.7

Position Proportioning Control can be implemented on those units provided with two SPST relay or two SSR driver outputs and the Position Proportioning (slidewire feedback) option.

Position Proportioning control permits the use of PID control when the final control element is a modulating device such as a motorized valve. Two outputs are required to control the valve. One output opens the valve, the second output closes the valve. The slidewire feedback is used to indicate the valve position to the instrument. The valve position will be dependant upon the process value, the setpoint and Tune mode parameters.

A Position Proportioning sensitivity adjustment is provided, which specifies a deadband around the setpoint to prevent the valve from oscillating. The valve rotation time must be entered, for proper operation, into the Tune mode parameter Ct1.

See Figure 4-1 for proportional bandwidth effect on the output.

FIGURE 4-1

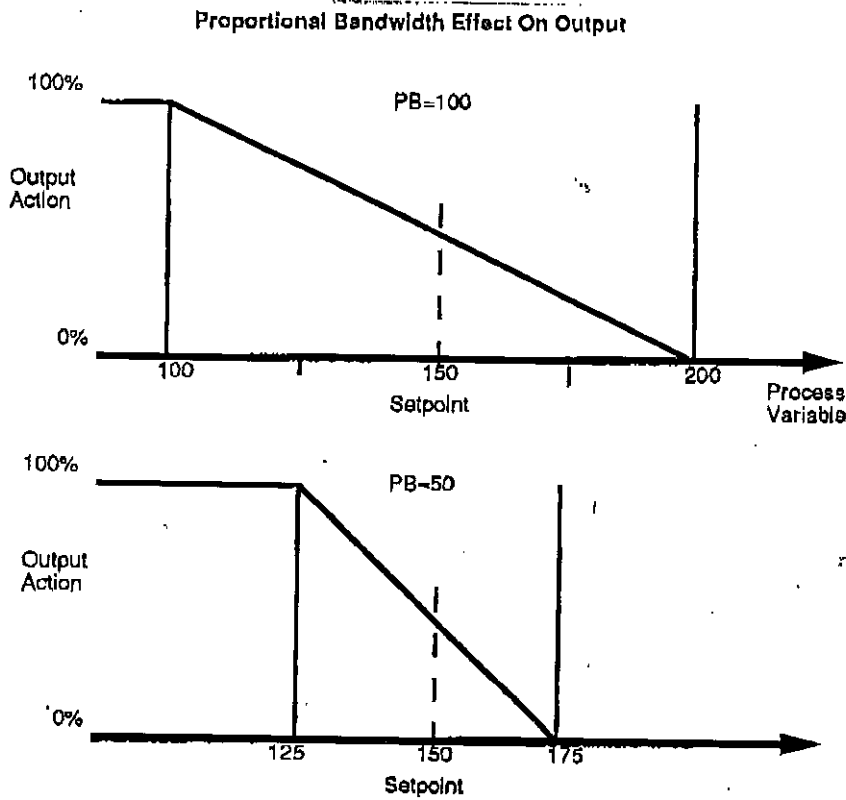

The Proportional Bandwidth is the area where the output is a percentage of the full output. The size of the proportional band determines what change in the output will result from a change in the process variable. In the upper figure when the process variable is at 125 the output will be at 75% of full output. In the lower figure the proportional bandwidth is smaller. When the process variable is at 125 the output is now at 100%. The larger the proportional band the smaller the "gain" and vice versa.

Dual Output Control 4.8

Dual output control can be performed when two outputs are specified. The outputs may be programmed for On-Off, Time Proportioning, or Current Proportioning, as applicable.

The output action is dependent upon the setpoint, the process value, and Tune mode parameters. If two proportional outputs are selected, both output proportional bands will be biased so that 0% of output is seen when the process value equals setpoint. The output(s) can be biased by the use of the Tune mode parameters FOP and SPPrd as shown below.

FIGURE 4-2

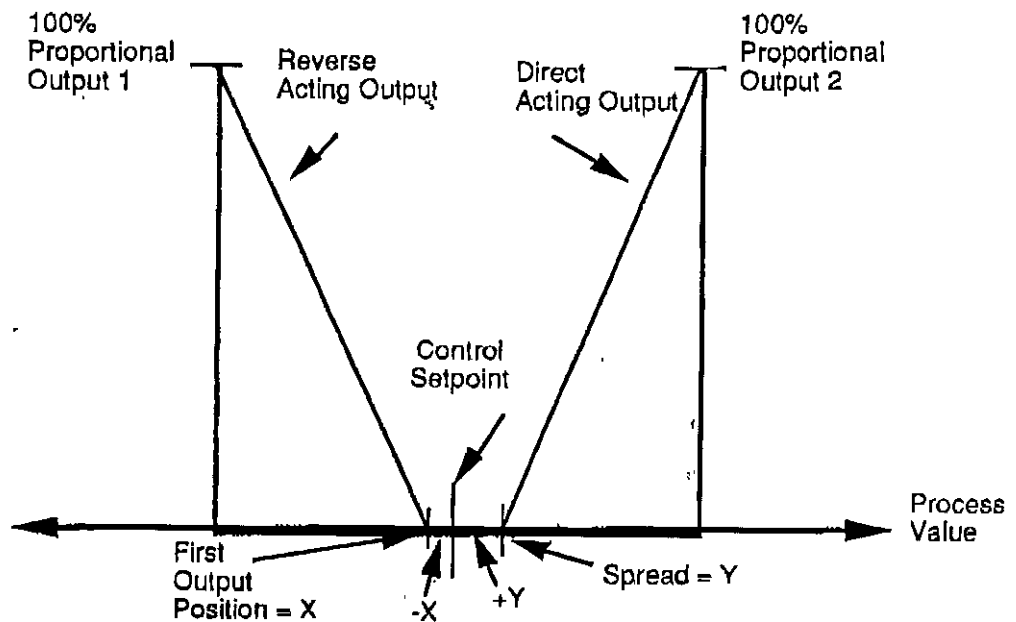

The first output is programmed as a proportional reverse output and the second as a proportional direct output. (See Glossary, page 63, for definitions of these terms). Dual proportioning outputs are provided with separate proportional band and cycle time adjustments for each output.

Manual Operation of Proportional Outputs 4.9

The Auto/Manual switching function applies to proportional control outputs only.

Switching between the automatic and manual control modes is accomplished by scrolling to the Standby mode and pressing the DOWN key to enter the mode. Switching from automatic to manual is always bumpless.

CAUTION: If the unit is in the Manual mode, be careful not to leave the process unwatched. Since the unit is intentionally ignoring the setpoint, it is possible to unintentionally let the process exceed safe limits. Limit devices must be used to guarantee the process does not get out of control.

The proportional output values initially displayed upon entry into the Standby mode will be the last output values calculated by the control algorithm. Changes made to output values are made "on-line".

When the unit is placed in manual, Po1 and/or Po2, as appropriate, will appear in the display. If the keys are depressed within 5 second intervals, the units will respond as follows:

If a code is displayed:

SCROLL - The corresponding value will be displayed

DOWN - The next code will be displayed

If a value is displayed:

SCROLL - The next code will be displayed

UP - The value will increment

DOWN - The value will decrement

To exit from the Standby mode (manual operation), depress the UP key twice. (Pressing the UP key once stops the cyclic display and leaves the controller in Standby) The controller will be in automatic control with Stby displayed. After a time-out period, the unit will display Ctrl. To get directly to the Ctrl display, press the UP key three times instead of twice. Shifting to the Control mode is balanceless.

STANDBY MODE FLOW CHART

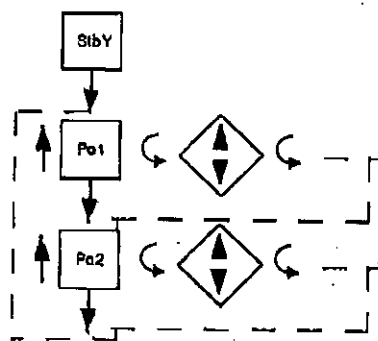

Key

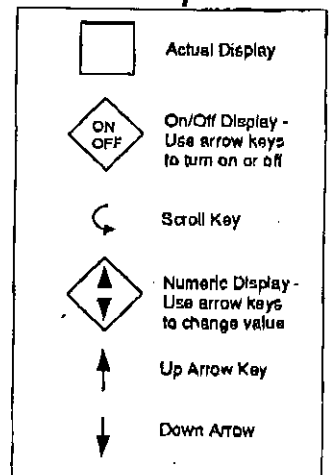

Automatic Transfer Function 4.10

Automatic transfer provides automatic switching from the Manual mode to the Control mode of operation when the process value reaches setpoint. This feature is selectable in the Program mode.

NOTE: If an error condition occurs while in the Manual mode and Automatic Transfer Function is selected, the output will go to a Failsafe condition.

Setpoint Adjustments 4.11

Local

Local setpoint adjustment is accomplished by using the keypad. Press the UP key to increase the setpoint value. Press the DOWN key to decrease the setpoint value. Holding the key pressed will cause the value to change slowly at first then increasingly faster. The range of the setpoint value can be limited by selecting the setpoint upper limit SPL in the Program mode. The setpoint value can be protected from inadvertent changes by disabling the Setpoint Change, ESPC, in the Enable mode.

Ramp Rate - EB Option Only

A selectable Ramp Rate function can be used to limit the rate at which the setpoint used by the control algorithm will change. This feature will also establish a soft startup. Upon power up, the instrument will take the initial process value as the setpoint. A setpoint ramp will be calculated to increase the setpoint from the initial process value to the setpoint that was seen prior to the power outage.

Sudden changes in the setpoint value entered via the keypad can be inhibited from effecting the control outputs by use of this feature. The internal setpoint used to control the process will ramp to the setpoint value entered at the rate of change selected.

FIGURE 4-3

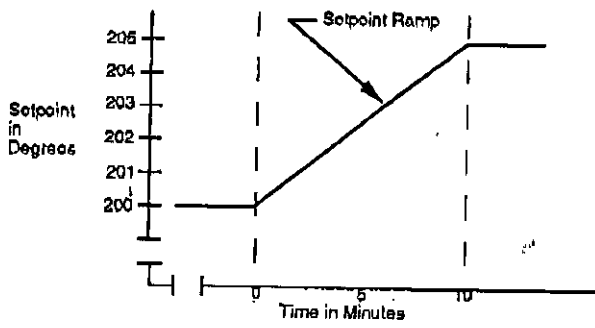

Remote Setpoint

Remote Setpoint adjustment is an optional feature. The instrument setpoint can be adjusted by supplying a signal to the remote setpoint terminals as indicated in the installation section. Local or Remote setpoint operation is selected by pressing and releasing the SCROLL key until the display reads setpoint select SPS. Press the DOWN key to enter the Setpoint Select mode, either local loc or remote rSP. To change the setpoint mode press the SCROLL key. To exit the setpoint mode press the UP key. To prevent unwanted setpoint mode changes, the Setpoint Select mode can be disabled in the Enable mode. The setpoint value can be adjusted by using the Digital Communications Option. Refer to the Protocol Manual (Form 2878) for more details about this option.

SETPOINT FLOW CHART

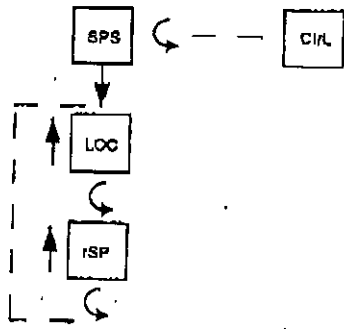

Key

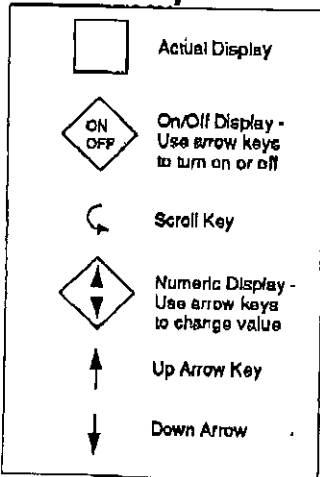

Process Re-transmission Output - EA Option Only

If the instrument is provided with a current output not used for process control, this output may be assigned to provide a linear re-transmission of the process value. This output can be used to provide a process signal to remotely installed recorders, panel meters, or data loggers. The process output is scaled for the application by using the Program mode parameters process/setpoint output value upper **Pou** and process/setpoint output value lower **PoL**. The current output resolution is @ 200 steps, so for the best re-transmission accuracy, the span between **Pou** and **PoL** should be as small as possible. If a current output is used for re-transmission, the corresponding control output, **out1** or **out2**, cannot be assigned to it.

The example illustrated in Figure 4-4 (below) shows a process re-transmission application for 0 to 200 degrees F.

FIGURE 4-4

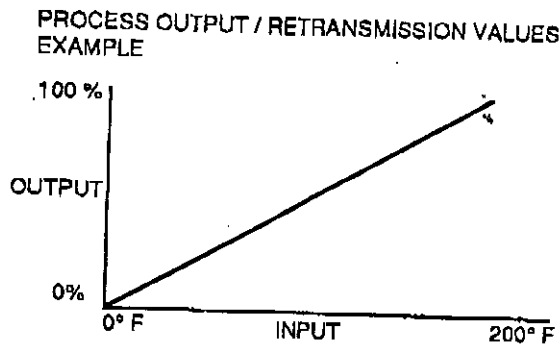

Setpoint Re-transmission Output - EA Option only

If the instrument is provided with a current output not used for process control, this output may be assigned to provide a linear re-transmission of the setpoint value. The setpoint output is scaled for the application by using the Program mode parameters process/setpoint output value upper **Pou** and process/setpoint output value lower **PoL**. The current output resolution is @ 200 steps, so for the best re-transmission accuracy, the span between **Pou** and **PoL** should be as small as possible. If a current output is used for re-transmission, the corresponding control output, **out1** or **out2**, cannot be assigned to it.

The example illustrated in Figure 4-5 (below) shows a setpoint re-transmission application for 0 to 400 degrees F.

FIGURE 4-5

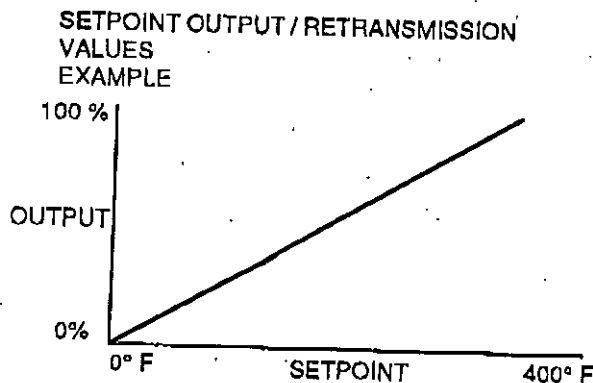

Service 5.1

This section contains Calibration, Test and Trouble-shooting procedures that can be performed by the user. Instruments are calibrated to its input type at the factory prior to shipment. Re-calibration should not be necessary under normal operating conditions.

Calibration 5.2

Caution: Do not attempt any of these calibrations without the proper test equipment with specifications equal to or better than those listed.

Press and release the SCROLL key to sequence the display until CAL appears. If CAL does not appear, refer to Section 3 for instructions on how to enable the Calibration mode. When CAL appears on the display, press the SCROLL key to advance the display to the other calibrations available.

CALIBRATION FLOW CHART

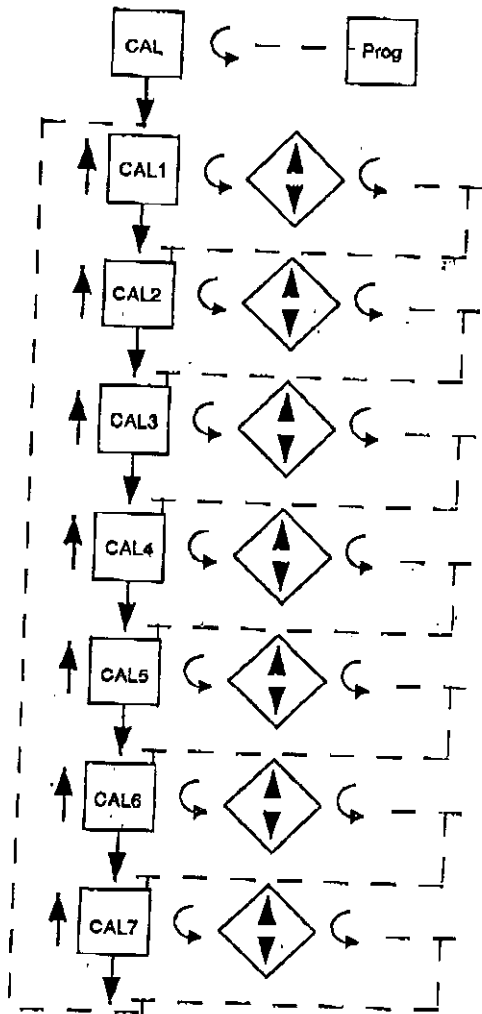

Key

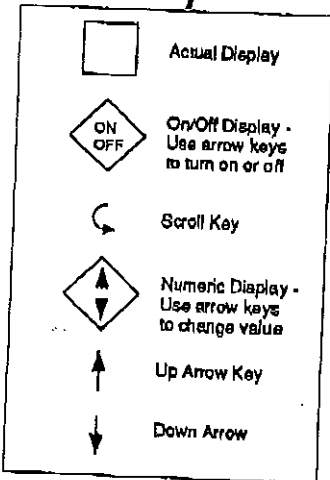

TABLE 5-1 CALIBRATION PROCEDURES

Calibration Procedure	Description
CAL 1	Re-Initialization of Program and Tune Mode values.
CAL 2	Main Calibration used by all inputs. This is the only calibration required for voltage and millivolt inputs.
CAL 3	Cold Junction Compensation calibration used to correct for component variation in CJC circuit.
CAL 4	Cold Junction utility. The temperature of the cold junction is displayed. No adjustment is made with this procedure.
CAL 5	RTD input calibration used to correct for component differences in the RTD input circuit.
CAL 6	CJC turn on/off
CAL 7	Factory Use Only

5.2.1 CAL 1 PARAMETER INITIALIZATION

This procedure is performed to erase the information that was entered in the Program and Tune modes. All parameters will be reset to default values. Prior to beginning this procedure record the Program and Tune mode parameters so that they can be re-entered. No special test equipment is required.

With CAL1 displayed, depress and hold the DOWN key, then press the SCROLL key. The display will momentarily go blank. Release the keys. CAL1 will reappear on the display. This calibration can be done again or another may be selected.

5.2.2 CAL2 MAIN CALIBRATION

This procedure determines and saves calibration values which correct for component variations relating to the input measuring function of the instrument. This is the only calibration required for the volt and millivolt inputs. Additional calibration procedures are required for thermocouple and RTD inputs.

A $50.00 \pm .01$ mVDC source is required for calibrating. In addition make sure that JU1 on the Processor board is in the "non volt" position. See Appendix A-2 (page 60).

Make sure all input wiring is disconnected. Short the input terminals 1 and 3 or apply 0.00 mV to the input. With CAL2 displayed, press and hold the DOWN key, then press the SCROLL key. Release both keys and the instrument will display hLd1. Depress the DOWN key; dELy will appear for up to ten seconds, then SCAn will appear for up to ten seconds. If the calibration reference number which appears is not between -50 and +50, proceed per note below. Otherwise, connect a $50.00 \pm .01$ mV source to the input terminals. Press the DOWN key and dELy will be displayed for ten seconds and then SCAn for ten seconds. Then CAL2 will reappear. If there is a problem, the appropriate error code will be displayed. Restore JU1 to the position necessary for the input type.

NOTE: If the calibration reference number falls outside the -50 to +50 range, depress the SCROLL key and CAL2 will be displayed. Depress the DOWN key and perform the calibration once more. Repeat the calibration until the number falls within the tolerance limits. If the calibration number remains outside these limits, check the connections to the test equipment and try the calibration again. If the number still does not approach the tolerance limits contact an Applications Service Engineer at the factory or a local representative.

PAGE 46

Error Recovery - see 5.4 (page 52) for details. However, be sure that the millivolt source is securely connected, functioning properly and the polarity is correct. Press the DOWN key to bring the instrument back to **dELy** and try the calibration again. The calibration can be exited at anytime **hLd1** or the reference number is displayed by pressing the SCROLL key.

CAL 2 QUICK CALIBRATION

This routine will allow the operator to execute a rough calibration on their unit via the keypad with no other equipment or disturbance to established wiring. It is intended to provide a partial recovery from a calibration corruption where the necessary equipment indicated in Cal 2-5 may not be available. It should be noted that this is not intended as a substitution to the main calibration procedure described earlier and may considerably deter from the accuracy of the instrument.

With **CAL2** displayed, press and hold the DOWN ARROW key, then press the SCROLL key. Release both keys and the instrument will display **hLd1**. Press and hold the UP ARROW key, then press the SCROLL key. The display will momentarily blank and then **CAL1** will be displayed. Release both keys and depress the UP ARROW key. **CAL** will be displayed.

5.2.3 CAL 3 COLD JUNCTION COMPENSATION

This procedure determines and saves calibration values which correct component variations relating to the cold junction compensation. This calibration must be preceded by **CAL2**, the main calibration, to properly calibrate the instrument. These two calibrations are the only ones needed for proper operation with a thermocouple input.

Test equipment: one type J thermocouple and one mercury thermometer, accurate to $\pm .25$ degree C or equivalent are required.

Make sure all input wiring is disconnected and connect the J thermocouple to the input. Place the thermometer next to the thermocouple and allow the controller to warm up for 30 minutes, before proceeding with the calibration.

With **CAL3** displayed, depress and hold the DOWN key. Then press the SCROLL key and the unit will display **hLd**. Release both keys. Press the DOWN key and **dELy** will be displayed for ten seconds, then **SCAN** for ten seconds. If **SCAN** remains in the display for much longer than ten seconds, refer to the note below. The instrument will compute and display the cold junction temperature to the nearest tenth of a degree C. Compare reading with thermometer and use the UP and DOWN keys to correct the reading, if necessary. To end the procedure press the SCROLL key and **CAL3** will be displayed again.

NOTE: If the instrument continues to display in **SCAN**, proceed as follows. With **SCAN** displayed, press the SCROLL key. **CAL3** should be displayed. With **CAL3** displayed, while pressing the DOWN key, press and release the SCROLL key. The instrument will display **hLd**. Press the UP key. The instrument will begin the calibration procedure with a default value and proceed to **dELy**. Complete calibration as described above.

Error Recovery - see 5.4 (page 52) for details on specific errors. The calibration can be exited at any time **hLd** is displayed by pressing the SCROLL key.

5.2.4 CAL 4 COLD JUNCTION TEMPERATURE UTILITY

This procedure displays the temperature sensed by the cold junction compensator (CJC).

No special test equipment is required.

With **CAL4** displayed, press and hold the DOWN key then press the SCROLL key and release both keys. **SCAN** will be displayed for ten seconds while the instrument computes the CJC temperature. The result will then be displayed to a tenth of a degree C. The input terminals must be shorted with a jumper wire. Remember, the temperature displayed is that of the CJC terminals not the ambient temperature. To exit, press the SCROLL key and **CAL4** will be displayed.

5.2.5 CAL 5 RTD INPUT

This procedure determines and saves calibration values which correct for component variations relating to RTD inputs. This calibration must be preceded by CAL2 to properly calibrate the unit.

Test equipment needed will include a Decade Box (Resistance Substitution) with .01% resolution or equivalent. Make sure the jumpers JU1 (Processor Board), JU2 and JU3 (Options boards) are in the proper positions for RTD Input. See Appendix A-2 (page 60) and A-3 (page 61, 62).

With CAL5 displayed press and hold the DOWN key, then press the SCROLL key and release both keys. hLd1 will then be displayed. Connect the Decade Box at 100 ohm setting across the input terminals 1 and 3 and Jumper terminals 1 and 5. Press the DOWN key and dELY will be displayed for up to ten seconds, then SCAN for ten seconds. When hLd2 is displayed, connect 277 ohms to the input and press the DOWN key. Again dELY will display for up to ten seconds, followed by SCAN for ten more seconds. CAL5 will be displayed after the calibration is completed.

Error Recovery - See section 5.4 (page 51) for details about specific errors.

The Calibration mode can be exited any time the unit displays hLd1 or hLd2 by pressing the SCROLL key.

5.2.6 CAL 6 COLD JUNCTION ON/OFF

With CAL 6 displayed, while pressing the DOWN ARROW key, press the SCROLL key. The instrument will display C6 and the number of the mode in effect. Mode 0 is the normal operating mode. The cold junction compensation is on. Mode 1 is the cold junction compensation disabled (off). Pressing the UP ARROW or DOWN ARROW will change the mode selection. The Mode 1 functions to facilitate input testing with a non-temperature compensated millivolt source used to simulate thermocouple input.

Test Mode 5.3

The Test mode can be entered, if enabled, by pressing and releasing the SCROLL key until tEST is displayed. Press the DOWN key and tSt1 will be displayed. This test can be initiated at this time or press the SCROLL key to advance to the desired test. Test 1, 2 and 3 are performed as a block so the display will advance from tSt1 to tSt4.

All available test procedures are listed in TABLE 5-2 (page 49). Test 1, 2, and 3 are performed on start up, periodically during Control, and on entry into the Test mode. Test 4 is executed on entry into and periodically during the Control mode. These tests can be used as trouble-shooting aids.

TEST MODE FLOW CHART

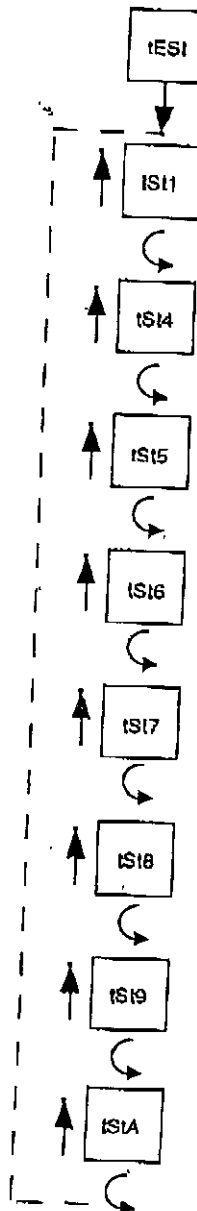
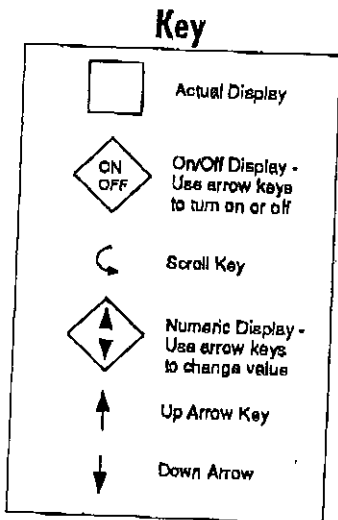

TABLE 5-2 TEST PROCEDURES AND DESCRIPTION

TEST	DESCRIPTION
Test 1	Microprocessor internal RAM test.; used to verify that the processor RAM is functioning correctly.
Test 2	External RAM test; used to test the instrument's RAM for proper function.
Test 3	EPROM checksum test; used to check program for correct data.
Test 4	External RAM checksum test; displays the number of times Error 16 and 17 have occurred.
Test 5	Verifies that all keys are functional and all LED displays are working.
Test 6	Used to verify that all relays and/or solid state relay driver outputs are working.
Test 7	Used to check the operation of Output 1, mA current output.
Test 8	Used to check the operation of Output 2, mA current output.
Test 9	Auxiliary input test; used to test position proportioning (slidewire feedback or remote setpoint voltage levels).
Test A	Communications hardware test; tests the send and receive functions.

5.3.1 TEST 1 - INTERNAL RAM TEST

Checks the Random Access Memory in the microprocessor. No special test equipment is required for this test. With Test 1 displayed tSt1 press and hold the DOWN key then press the SCROLL key. tSt1 will be displayed momentarily while the test is in progress. Upon successful completion the instrument will initiate Test 2 automatically.

5.3.2 TEST 2 - EXTERNAL RAM TEST

Checks the operation of the RAM external to the microprocessor. No special test equipment is required. After completion of Test 1, tSt2 will be displayed momentarily while the test is in progress. Upon successful completion of Test 2, Test 3 will be initiated.

5.3.3 TEST 3 PROGRAM - EPROM TEST

This is a checksum test to verify data integrity of the stored program. No special test equipment is required for this test. After completion of Test 2, tSt3 will be displayed momentarily while the test is in progress. Upon successful completion the instrument will display tSt1.

5.3.4 TEST 4 - EXTERNAL RAM CHECKSUM TEST

This is a checksum test to verify the integrity of data stored in RAM and indicate the number of times the instrument has had an Error 16 or 17. No special test equipment is required for this test. With tSt4 displayed, press and hold the DOWN key then press the SCROLL key. The display will go blank momentarily, then briefly display two numbers and then tSt4 will be displayed. These numbers indicate the number of times Error 16 and 17 have occurred respectively. Test 4 can be executed again, or another test may be selected. Test 4 occurs when the instrument enters the Control mode and periodically during Control mode operation.

5.3.5 TEST 5 - KEYPAD/DISPLAY TEST

This test allows the operator to verify that the keys work and that all display elements can be lighted. No special test equipment is required for this test. With tSt5 displayed press and hold the DOWN key then press the SCROLL key. The display will go blank. Release both keys, then press each key to be tested.

<u>KEY</u>	<u>DISPLAY</u>
SCROLL	SCRL
UP KEY	uAro
DOWN KEY	dAro
UP AND DOWN KEYS	ALL LED's AND SEGMENTS LIGHTED

To exit Test 5, press the SCROLL and UP key simultaneously. tSt5 will be displayed.

5.3.6 TEST 6 RELAY/SSR DRIVER OUTPUT TEST

Verifies that the Relay/SSR Driver output(s) are working. A volt/ohm meter will be useful to verify the output operation. With tSt6 displayed press and hold the DOWN key then press the SCROLL key. oFF will be displayed. For SPST relay outputs, connect the volt/ohm meter, set to ohms, across the relay outputs. For SSR driver outputs, connect the volt/ohm meter across the output terminals in the volt/DC mode. Depress the DOWN key repeatedly to advance through the following sequence:

<u>DISPLAY</u>	<u>RELAY ON</u>
rLYA	A Only
rLYb	B Only
rLYC	C Only
oFF	None

The relays should be checked for continuity when on and high impedance when off. SSR drivers will output 5 VDC when on and 0 VDC when off. This sequence may be repeated by using the DOWN key. To exit press the SCROLL key and tSt6 will be displayed. The existence of relay SSR outputs is dependent upon the hardware configuration.

5.3.7 TEST 7 - CURRENT OUTPUT 1 TEST

This test allows the user to verify that current Output 1 is functioning properly and will allow the adjustment of the current output value for testing of associated equipment. A volt meter with an appropriate shunt resistor or milliamp meter will be needed to execute this test. With tSt7 displayed, depress and hold the DOWN key, then press the SCROLL key. Connect the DVM or milliamp meter across the output terminals 5 and 6. The display will indicate 4 milliamps output. Use the UP and DOWN keys to vary the output in 1mA steps. The current output reading should be $\pm 0.5mA$ at any output value. To exit the test, press the SCROLL key and "tSt7" will be displayed. The existence of the mADC current output is dependent upon the hardware configuration as indicated by the model number.

5.3.8 TEST 8 - CURRENT OUTPUT 2 TEST

This test is the same as Test 7 except for Output 2. Check the output at terminals 7 and 5.

5.3.9 TEST 9 - AUXILIARY INPUT TEST

This test allows the operator to verify that the auxiliary inputs used for position proportioning (slidewire) feedback or remote setpoint is functioning properly. A variable voltage source, 5 VDC will be required to execute this test. With **tSt9** displayed, press and hold the DOWN key then press the SCROLL key. The Auxiliary input voltage will be displayed to the nearest hundredth of a volt. Connect the +5V source across the Auxiliary input terminals (terminals 8 and 5) and adjust the voltage. Verify that the voltage displayed changes accordingly. The displayed voltage should be typically $0 - 5VDC \pm 0.3$ volts. To terminate the test, press the SCROLL key. The display will show **tSt9**.

The existence of the auxiliary input tested in Test 9 depends upon the hardware configuration as indicated by the model number.

5.3.10 TEST A - COMMUNICATIONS HARDWARE TEST

(Communications Option only)

This test allows the operator to verify that the communications hardware is functioning properly. With **tStA** displayed, press and hold the DOWN key then press the SCROLL key. The display will indicate **SEnd**. Each time the DOWN key is depressed, the unit will toggle between **SEnd** and **rEC** (receive). With the desired function selected, depress the SCROLL key.

In the **SEnd** (send or transmit) mode, the instrument will repeat the following sequence. First, the transmitter will go logic 1 for one second. Next, the transmitter will change the logic level to 0 for one second. Then, the transmitter will be disabled for one second. In the **rEC** mode, the transmitter will be disabled. In either mode, the instrument will monitor the line logic level. The display will be **rEC0** when a logic 0 is on the line. The display will be **rEC1** when logic 1 is on the line. In the **SEnd** mode, the unit will display **rEC** when the transmitter is disabled.

To perform an internal test to verify the operation of the hardware, place the instrument in the Send mode. Verify that the display cycles through **rEC1**, **rEC0**, and **rEC**. To verify that the transmitter functions properly, two LED's, each with a current limiting resistor, can be connected to the communications terminals, with their polarities connected opposite of each other. The following three states will be produced: one LED on, then the other LED on, then both off. Alternately, a load resistor can be placed on the terminals, the voltage generated across the load resistor is as follows: $> +3$ VDC then > -3 VDC and then 0 VDC. The terminals used are 7 & 8.

Another test method, would be to connect one or more instruments in the Receive mode to an instrument in the Send mode. The instruments in the Receive mode should have their display alternating in sync with the instrument that is in the Send mode. When the sending unit displays **rEC**, the receiving units should display **rE1**.

To terminate the test, press the SCROLL key for one second. Upon exit, **tStA** will be displayed.

Trouble-shooting and Diagnostics 5.4

This section consists of two columns. The first column is a list of some possible instrument conditions. The second column is a list of steps that should improve the condition. The steps should be performed in order until the condition improves or all the steps have been tried. If the instrument condition has not improved, contact the nearest representative or the factory for assistance.

Trouble-shooting should be performed by qualified personnel using the proper equipment and following all safety precautions. Whenever possible, the trouble-shooting should be accomplished with the electrical-power disconnected. The instrument contains static sensitive components so care should be taken to observe anti-static procedures.

Condition	Correction Steps
Display is blank (dark)	<ol style="list-style-type: none"> 1. Verify that the correct instrument power, as indicated on the wiring label on the housing, is supplied to terminals A & B. If the voltage is not correct, check the power source. 2. Turn off the instrument power. Wait about 5 seconds, then turn the power on again. 3. Turn off the instrument power, loosen the front panel screw, and remove the instrument from the housing. Inspect the instrument for poor connections. <ol style="list-style-type: none"> a. The white ribbon cable that connects the Processor board (Appendix A-2, page 60) to the Power Supply Board (Appendix A-1, page 59) must be properly aligned and seated. b. The Front Display board pins should be properly aligned and seated in the sockets on the Processor board (Appendix A-2, page 60) and the Power Supply board (Appendix A-1, page 59). c. The Display Driver (U-1), located on the Display board, must be free of corrosion and firmly seated in the socket. Reinsert the instrument in the housing, tighten the panel screw, and turn on the power. 4. Turn off the instrument power. Press and hold the UP and DOWN keys. Turn on the power. Hold the keys depressed for about 10 seconds. If the display lights the model number, Program and Tune mode parameters will need to be re-entered (page 28 & 33 or the Software Ref. Sheet, page 70, if already filled out).
Model Number Displayed is Incorrect	<ol style="list-style-type: none"> 1. Turn off the instrument power, wait 5 seconds then reapply the power. Verify that the number displayed during the power up sequence is the same as indicated on the label affixed to the lower front of the display bezel.

Note: To re-initialize, follow steps 2 & 3.

2. Turn off the power to the instrument. Press and hold the UP and DOWN keys and turn on the power. Keep the keys depressed until the model number resets to 2100-000. Release the keys and turn off the power.
3. To enter the correct model number, press and hold the SCROLL and DOWN keys and turn on the instrument power, 2100 should be displayed. Wait about 5 seconds and release the keys. The display should remain 2100. Use the UP/DOWN keys as necessary to change the displayed number to match the first 4 digits of the model number. After adjusting the first 4 digits to the proper values, press the SCROLL key and the display will change to 000-. Use the UP/DOWN keys to set the last 3 digits of the model number to the correct values. Press the SCROLL key and the power up sequence will complete. The Program and Tune mode parameters will need to be re-entered (page 28 & 33 or the Software Ref. Sheet, page 70, if already filled out).

Relay/SSR Driver Output(s) Malfunction

1. Verify that the Program and Tune mode parameters are correctly set (pages 28 & 33 or the Software Ref. Sheet, page 70, if already filled out).
2. Turn off the power to the instrument. Wait about 5 seconds and turn the power on again. Confirm that the model number displayed during the power up sequence indicates that the output(s) is/are present in the instrument. This number should match the number on the label affixed to the lower front of the display bezel. If model # is incorrect, follow steps for "Model # displayed is incorrect".
3. Turn off the power to the instrument. Loosen the front panel screw and remove the unit from the housing. Inspect the Power Supply board (Appendix A-1, page 59) for the presence of the output device(s). Relay A is located at K1, Relay B at K2, and Relay C at K3. A relay output will appear to be a cube. The SSR Driver will appear as a resistor and a jumper wire. The output will not work if the hardware is not present.
4. Check the output operation by performing Test 6 as described in the Test section (page 48). If the output(s) function(s) in the Test Mode re-examine the Program and Tune Mode Parameters settings (page 28 & 33, or the Software Ref. Sheet, page 68, if already filled out).
5. If the output appears not to turn off, remove the power to the instrument. Loosen the front panel screw and take the unit out of the housing. Clip the resistor located on the Power Supply (Appendix A-1, page 59) for the output(s) that seem to stay on. A .01 microfarad, 1 KV capacitor should be connected from the terminal listed below, to the AC ground for the output where the resistor indicated was removed.

Relay A	R12	Terminal C
Relay B	R13	Terminal E
Relay C	R14	Terminal G

(Continued on next page)

(Continued from page 53)

Return the instrument to the case and tighten the front panel screw. Turn the power on to the instrument and check the operation of the output(s).

**mADC Output(s)
Malfunction**

1. Verify that the Program and Tune mode parameters are correctly set (page 28 & 33 or the Software Ref. Sheet, page 70, if already filled out).
2. Turn off the power to the instrument . Wait about 5 seconds and turn the power on again. Confirm that the model number displayed during the power up sequence indicates that the output is present in the instrument...The number should match the model number on the label located on the lower front of the display bezel. If model # is incorrect, follow steps for "Model # displayed is incorrect" (page 52).
3. Turn off the power to the instrument. Loosen the front panel screw and remove the unit from the housing. Inspect the Option board (Appendix A-3, page 61, 62) for the presence of the Current Output Driver IC. Current 1 output is U-1 and Current 2 output is U-5. The current output cannot function without the hardware being present . Return the instrument to the housing and tighten the front panel screw.
4. Refer to the Test section (page 48) and carry out the procedure for the output(s) that is/are not working. Test 7 operates current Output 1 and Test 8 for current Output 2. If the current output operates properly in the Test mode re-check the Program and Tune mode parameters (page 28 & 33 or the Software Ref. Sheet, page 70, if already filled out).

Error Code Displayed - The display of error codes will cause on/off outputs and proportional outputs to turn off.

**SnSr
Sensor Break or out of range**

1. Inspect the sensor for proper operation and connection to the instrument. Acceptable sensor ranges for the instrument are listed in the Specifications section of Appendix D (page 67).
2. Verify that the Program Mode input selection matches the sensor input connected.
3. Check that the input conditioning jumpers on the Processor board (Appendix A-2, page 60) and the Option Board (Appendix A-3, page 61, 62) are in the proper position for the sensor input.
4. Perform the calibration procedure(s), as described in the Calibration section (page 44) , for the sensor input type.

rSEr
Remote Setpoint Error

1. Check that the Remote Setpoint signal is present and of the correct polarity between terminals 8 (+) and 5 (-).
2. Perform the Auxiliary Input Test, Test 9 as described in the Test section (page 51), the voltage indicated during the test should be the same as measured in the preceding step.
3. Verify that the Remote Setpoint input voltage range selected in the Program Mode (page 28) is the same as the voltage that is present as the Remote Setpoint input terminals.

FbEr
Slidewire Feedback Error

1. Inspect the Slidewire Feedback connections at terminals 8, 7, and 5. Be sure that the connections are the same as shown in the position proportioning illustration (page 21).
2. Measure the resistance of the Slidewire segment. The minimum resistance must be 135 ohms, the maximum 10 K ohms.
3. Perform the Auxiliary Input Test, Test 9 as described in the Test section, the voltage indicated should be between 0 and 5 VDC.
4. Turn off the power to the instrument. Loosen the front panel screw and take the instrument out of the housing. Verify that the jumper JU-1 on the Option Board (Appendix A-3, page 61, 62) is in the Motor Modulation position.

Hi - Input more than 10% Over Span

1. Perform the steps listed for the SnSr error condition (page 54).

Lo - Input more than 10% Under Span

1. Perform the steps listed for the SnSr error condition (page 54).

6 - display overrange (the "broken 6" appears on the left side of the display)

1. If this error code is displayed as a Program or Tune mode parameter value, perform the CAL 1 procedure as described in the Calibration section (page 45).
2. If this error code appears as part of the model number during the power up sequence, follow the steps listed for the Model number incorrect condition (page 52).

Er 1 - Microprocessor RAM Failure

1. Turn off the power to the instrument.
2. Loosen the front panel screw and remove the instrument from the housing. Inspect that the microprocessor (U1) is properly seated in the socket located on the Processor board (Appendix A-2, page 60). Return the instrument to the housing and tighten the front panel screw. Turn on the power.

Er 2 - External RAM Failure

1. Turn off the power to the instrument. Wait 5 seconds, and turn the power on.

Er 3 - EPROM Checksum Failure

1. Perform the steps listed for Er 1 except that the EPROM (U2) on the Processor board should be inspected.

PAGE 56

-
- Er 4 - RTD Mismatch Error**
1. Check the connections to the instrument for the RTD Input Calibration CAL5 as described in the Calibration section (page 47). Repeat the RTD Input Calibration.
-
- Er 5 - No Zero Crossings Detected**
1. Turn off the power to the instrument. Wait 5 seconds and turn the power on.
 2. Turn off the instrument power. Loosen the front panel screw and remove the instrument from the housing. Inspect the white ribbon cable that connects the Processor board to the Power Supply board. Be sure that the cable is properly aligned and seated in the socket on the Power Supply board. Return the instrument to the housing and tighten the front panel screw. Turn on the power to the instrument.
 3. Connect the instrument to another AC power source.
-
- Er 6 - AC line below 45 HZ**
1. Turn off the power to the instrument. Wait 5 seconds and turn the power on.
 2. Turn off the instrument power. Loosen the front panel screw and remove the instrument from the housing. Inspect the white ribbon cable that connects the Processor board to the Power Supply board. Be sure that the cable is properly aligned and seated in the socket on the Power Supply board. Return the instrument to the housing and tighten the front panel screw. Turn on the power to the instrument.
 3. Connect the instrument to another AC power source.
-
- Er 7 - AC line over 65 HZ**
1. Turn off the power to the instrument. Wait 5 seconds and turn the power on.
 2. Turn off the instrument power. Loosen the front panel screw and remove the instrument from the housing. Inspect the white ribbon cable that connects the Processor board to the Power Supply board. Be sure that the cable is properly aligned and seated in the socket on the Power Supply board.
-
- Er 8 - Cal 2 Volt Input Error**
1. Check that 50 mVDO is properly connected to the instrument and is within the tolerance limits as indicated in the CAL 2 procedure of the Calibration section (page 45).
 2. Loosen the front panel screw and remove the instrument from the housing. Inspect the Processor board (Appendix A-2, page 60) to insure that the input conditioning Jumper JU 1 is in the non-volt position.
 3. Perform the CAL 2 procedure as described in the Calibration section (page 45).
-
- Er 9 - ADC Reference Number Error**
1. Perform the CAL 2 procedure as described in the Calibration section (page 45).

Er 10 - ADC Reference Voltage Error

1. Perform the CAL2 procedure as described in the Calibration section (page 45).

Er 11 - Cold Junction Compensation Error

1. Be sure the Cold Junction Sensor is firmly attached to terminals 2 and 4.
2. Perform the CAL 3 procedure as described in the Calibration section (page 46).

Er 12 - CAL 2 Voltage Error

1. Check that 50 mVDC is properly connected to the instrument and is within the tolerance limits as indicated in the CAL 2 procedure of the Calibration section (page 45).
2. Loosen the front panel screw and remove the instrument from the housing. Inspect the Processor board (Appendix A-2, page 60) to insure that the input conditioning jumper JU1 is in the non-volt position.
3. Perform the CAL 2 procedure as described in the Calibration section (page 45).

Er 13 - RTD CAL 5 Input Error

1. Check that the resistance device is of the correct value and properly connected to the instrument and is within the tolerance limits as indicated in the CAL 5 procedure of the Calibration section (page 47).
2. Loosen the front panel screw and remove the instrument from the housing. Inspect the Processor board (Appendix A-2, page 60) to insure that the input conditioning jumper JU1 is in the non-volt position and that the Option board jumpers JU2 and JU3 are in the RTD position.
3. Perform the CAL 5 procedure as described in the Calibration section (page 47).

Er 14 - Cold Junction Compensation Error

1. Be sure the Cold Junction Sensor is firmly attached to terminals 2 and 4.
2. Perform the CAL 3 procedure as described in the Calibration section (page 46).

Er 15 - Ground Reference Tolerance Error

1. Perform the CAL 2 procedure as described in the Calibration section (page 45).

Er 16 - Program/Tune Mode Checksum Error

1. Record all Program and Tune mode Parameters. Perform the CAL 1 procedure as described in the Calibration section (page 45). Re-enter the Program and Tune mode Parameters (page 28 & 33 or the Software Ref. Sheet, page 70, if already filled out).

Er 17 - Calibration Checksum Error

1. Perform the calibration procedures that are needed for the input sensor that will be used.

Er 20 - Setpoint Validation Error

1. Use the UP or DOWN key to change the setpoint value.
2. Record all Program and Tune mode Parameters. Perform the CAL 1 procedure as described in the Calibration section (page 45). Re-enter the Program and Tune mode Parameters.

PAGE 58

Er 36 - Incorrect Crystal For Digital Comm.	<ol style="list-style-type: none">1. Turn off the power to the instrument, wait 5 seconds, then turn the power on.2. Check crystal, Y1, for 11 MHZ (see Appendix A-2, Page 60).
Er 37 - Incorrect Micro. For Digital Comm.	<ol style="list-style-type: none">1. Turn off the power to the instrument, wait 5 seconds, then turn the power on.2. Check to see if U1 is marked "8032" (see Appendix A-2, Page 60).
Momentary Er 70 - Controller unable to respond within 250 milliseconds.	<ol style="list-style-type: none">1. Tried to communicate while unit was in a non-control mode.
Momentary Er 71 - Byte received before the response was transmitted.	<ol style="list-style-type: none">1. The unit received a request before proper amount of time has elapsed since last request.
Momentary Er 72 - Incorrect Block check character was received.	<ol style="list-style-type: none">1. Data received not valid, possible corruption on the comm link. Possible noise.
Momentary Er 73 - Byte received with incorrect parity.	<ol style="list-style-type: none">1. Improper parity selection on the transmitting terminal.2. Incorrect baud rate.3. Noise

Appendix A Board Layout - Jumper Positioning

FIGURE A-1 - Power Supply Board

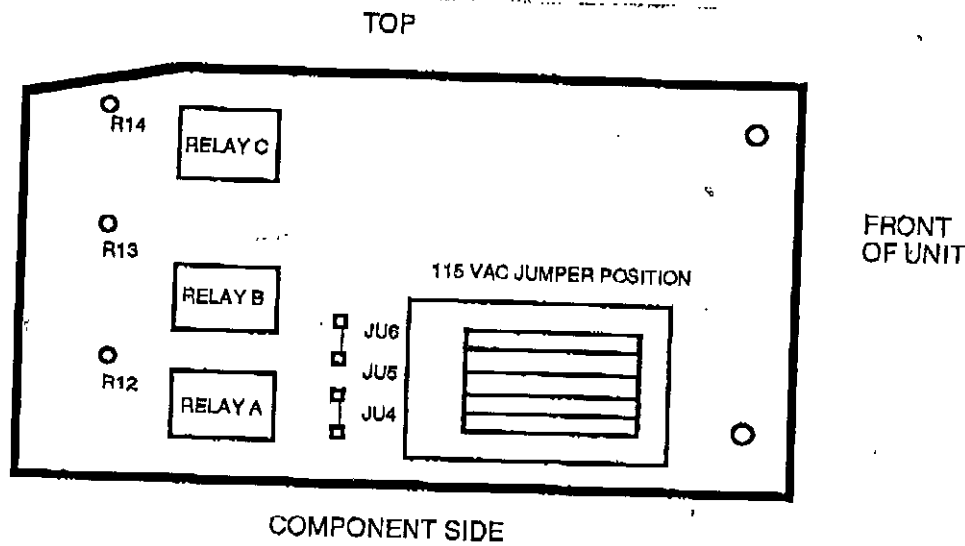

230 VAC UNITS MAY BE
FIELD CONVERTED
TO 115 VAC BY MOVING
JUMPERS AS SHOWN
ABOVE .

115 VAC UNITS CANNOT
BE FIELD CONVERTED
TO 230 VAC!

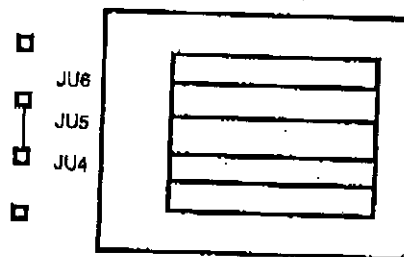

FIGURE A-2 - Processor Board

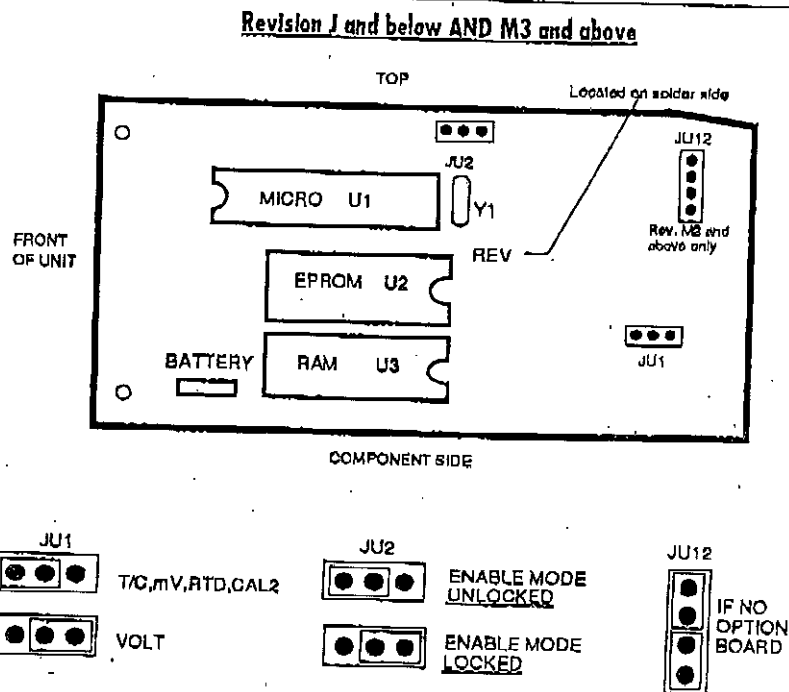
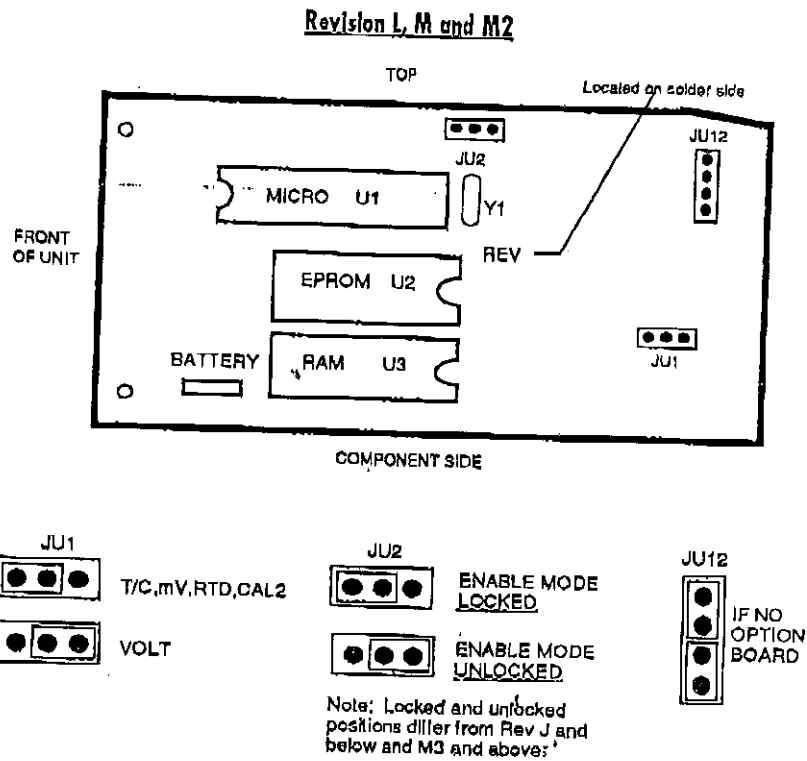
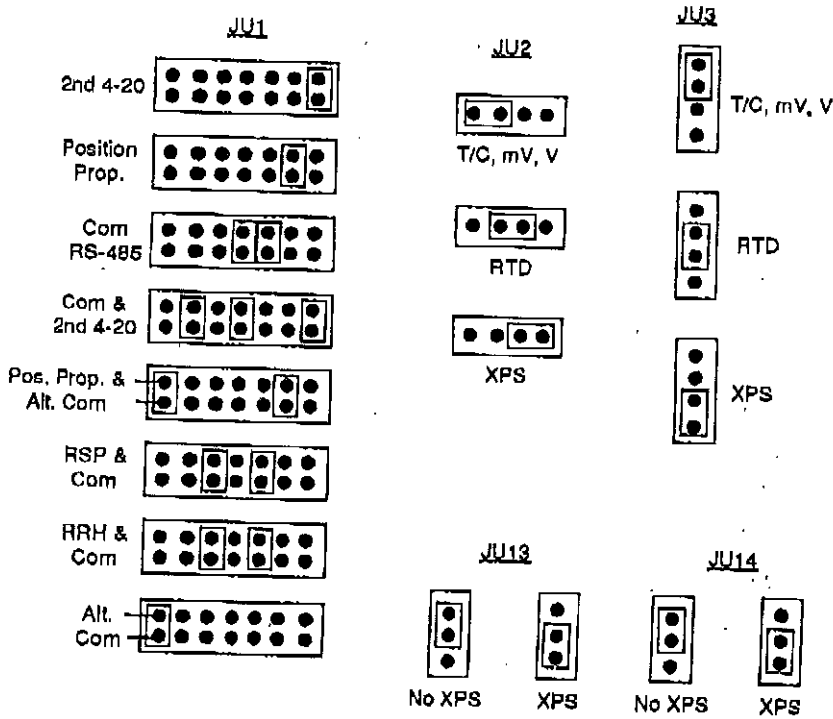
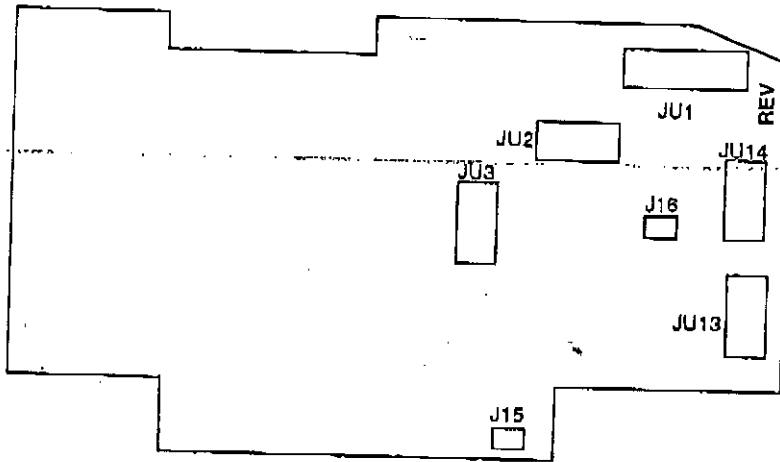
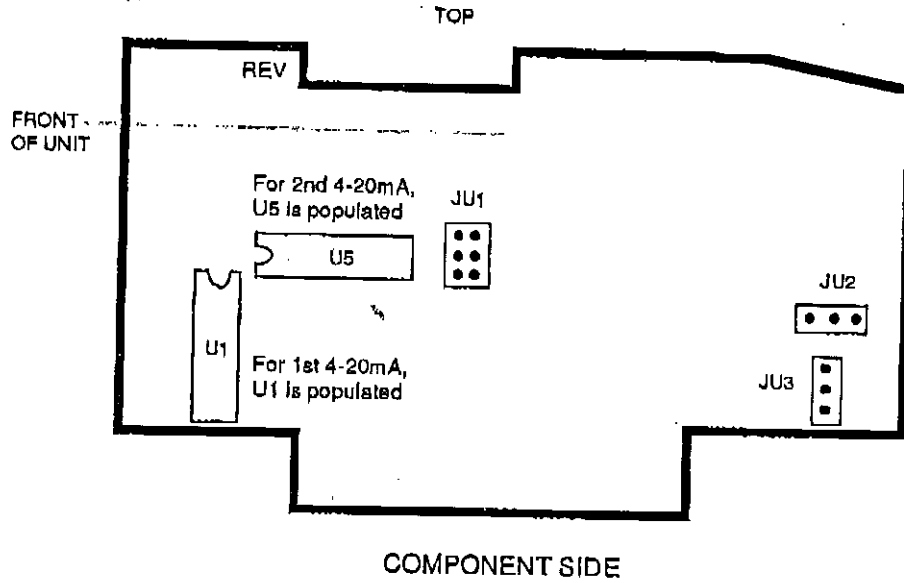

FIGURE A-3 - Option Board, Revision E and above (For Rev. D and below, see next page)



J15 - AC Input XPS cable from transformer
 J16 - XPS to Relay C

FIGURE A-3 - Option Board, Revision D and below



JU1

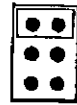

2ND 4-20 mADC

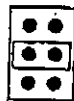

MOTOR MODULATION/
POSITION PROPORTIONING
POTENTIOMETER REMOTE
SETPOINT



DIGITAL
COMMUNICATIONS
422/485

JU2

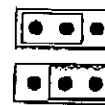

RTD

JU3



RTD



T/C, mV, VOLT
(NON-RTD)

T/C, mV, VOLT
(NON-RTD)

Appendix B

Glossary of Terms

Automatic Reset (Integration)

Automatic reset is a Tune mode parameter that will bias the proportional output(s) to compensate for process load variations. This parameter is adjustable from 0.0 to 100.0 repeats per minute. Factory default is 0.0. The display codes is ArSt.

Automatic Transfer

Automatic transfer is a Program mode parameter that will allow the instrument to switch from the Manual to the Control mode of operation automatically when the process value reaches setpoint.

Balanceless Transfer

This feature prevents changes in proportional output when changing from the Manual to Control mode of operation. When transferring from the manual mode to the control mode, the proportional outputs will be "balanceless" regardless of whether the unit is inside or outside the proportional band. This only holds true if the Auto Reset (ArSt) value is greater than 0.

Bumpless Transfer

This feature prevents changes in proportional outputs when changing from the Control to the Manual mode of operation only.

Control Algorithm

A pre-programmed series of instructions that are used by the instrument when determining the status of the output(s).

Cycle Time

This Tune mode parameter is used to select the on/off cycle time for time proportioning outputs (Ct1 for Output 1 and/or Ct2 for Output 2). (See page 29, section 4.5)

When using the Position Proportioning option, Ct1 must be selected for the stroke time of the motor.

Display Filter Factor

This Program mode parameter is used to dampen the process value displayed. The selections range from 1 through 20, the value represents the number of process scans that will be averaged for the display value. Factory default is 1, no filtering.

Engineering Units Upper and Engineering Units Lower

These Program mode parameters are used with volt, millivolt, and milliamp inputs. The Engineering Units Upper EUu should be selected as the value to be displayed when the input is at maximum. The Engineering Units Lower EuL should be selected as the value to be displayed when the input is at minimum.

First Output Position

This parameter is adjustable from -1000 to 1000 units and represents a shift or offset of the on-off actuation points or proportional band for the first output relative to the normal position. For example, a negative value could be used to offset an expected overshoot. First Output Position also shifts the proportional band with respect to the process value range outside of which integral action is inhibited. Factory default is 0. Display code FoP.

PAGE 64**Hysteresis**

This parameter is adjustable from 0 to 300 units representing the width of the band (half above and half below setpoint). Used with On-Off or Alarm outputs to reduce cycling. For instance, with a value of 4 and a setpoint of 70, the output will turn On when the process variable drops to 68 and stays On until 72 is reached, then turns Off the output. Factory default is 3. Display code is HySt.

Input Correction

This parameter is used to adjust the process variable value to compensate for sensor errors. This Program mode parameter is selectable from -300 to + 300 degrees/units. The factory default is 0.

Manual Reset

This parameter is adjustable from -1500 to 1500 units representing a manual shift of proportional band(s) relative to the normal position. Manual reset is intended to be used when automatic reset is not used to allow compensation for deviations from setpoint which remain after the process has stabilized. Factory default is 0. Increasing the value increases the process variable, i.e. if the process variable stabilized too low, increase the manual set. Integral action, and conversely reset-windup inhibit apply over the same process value range regardless of the manual reset value. Display code rSEt.

Position Proportioning Sensitivity

A percentage of the first output proportional band width (Pb1).

Process Filter Factor

This Program mode parameter is used to dampen the process value used to calculate output action. The process value is averaged to dampen the control outputs. This parameter is adjustable from 1 to 20. Factory default is 1.

Process Retransmission Output (EA Software Option)

This parameter allows for a linear milliamp proportional output relative to the process value. The current output may be scaled over a range selectable by the user. This output can be used to supply the process variable signal to remote chart recorders, panel meters, and data logger instruments.

Process Output Upper and Lower Values (Used In conjunction with process or setpoint retransmission output)

These parameters specify the process or setpoint value range over which the assigned current output will vary in a linear manner from 100% to 0%. If the process or setpoint value is greater than Pou, the output will be 100%. If the process or setpoint value is less than PoL, the output will be 0%. Factory default values are 2000 for the upper value and 0 for the lower value. Display codes Pou (upper) and PoL (lower).

Process Rounding

This Program mode parameter is used to determine the step size of the process value that will be seen on the display. This feature can be used to reduce display fluctuation. This parameter is adjusted from 1 to 100 degrees/units. The factory default is 1, no rounding (e.g. Process rounding = 2, Process Value Display - 4, -2, 0, 2, 4, etc.).

Process Variable

The process variable refers to the condition of the process being measured (sensed). The instrument will accept process inputs other than temperature (pressure, level, flow, etc.).

Proportional Band

This Tune mode parameter selects the span of the proportional output range. This parameter is adjustable from 1 to 3000 degrees/units. Factory default is 100. If Output 1 is selected as a proportional output, a display code of Pb1 will be seen. If Output 2 is selected as a proportional output, the display code will be Pb2.

Rate (Derivative)

This parameter is adjustable from 0.0 to 10.0 minutes and specifies how the control action responds to the rate of change in the process variable. For example, if the process variable is rising rapidly to setpoint, power is turned off sooner than it would be if the rise were slow. In effect, derivative action anticipates lags within the system and shifts the proportioning band by an amount determined by the rate of change of the input sensor. Magnitude of the shift is determined by a derivative time constant. If the time constant is, say, .1 minute (6 seconds), for every unit per second rate of change of the process variable at the sensor, the proportioning band is moved 7 units in the direction that helps control. Likewise, if the time constant is 1 minute (60 seconds), for every unit per second rate of change of the process variable at the sensor, the proportioning band is moved 60 units in the direction that helps control. Factory default is 0.0. Display code rAtE.

Setpoint Re-transmission Output (EA Software Option)

This parameter allows for a linear milliamp output relative to the setpoint value. The current output may be scaled over a range selectable by the user. This output can be used as a manual setting station.

Spread (Second Output Position)

This parameter is adjustable from -1000 to 1000 units and represents a shift or offset of the on-off actuation points or proportional band for the second output relative to the normal position. A positive value creates a gap where no control outputs are on, a negative value creates an overlap of control outputs (if the first output position is at the normal position). Second Output Position also shifts the proportional band with respect to the process value range outside of which Integral action is highlighted (reset-windup inhibit). Factory default is 0. Display code SPrd.

Setpoint Ramp Rate

This Program mode parameter provides a rate of change control of the instrument setpoint value. This parameter is used to inhibit sudden upsets in the instrument control caused by large setpoint changes. This feature also creates a soft start when the instrument power is turned on. The instrument will read the process value at the time the power was turned on as the setpoint value. A rate of change ramp will change the internal setpoint to the setpoint seen by the instrument at the time the power was turned off.

Appendix C - Order Matrix

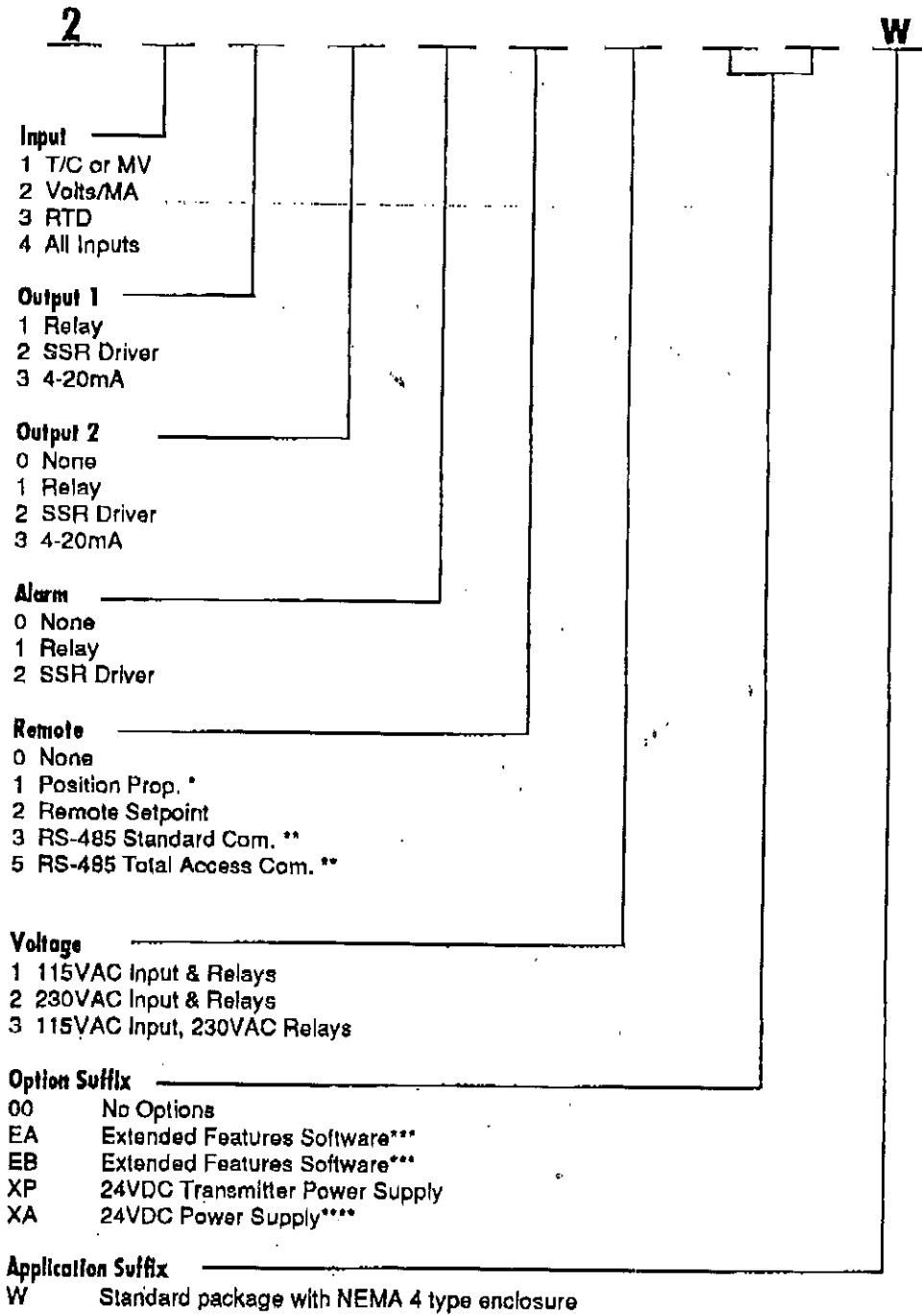

* Limited to Model 2X11X1X or 2X22X1X
 ** Cannot be included when Output 2 selection is 3.
 *** Suffix Option EB includes the EA features.
 **** Cannot be included when Output 3 selection is 1 or 2.

Note: RS-485 Total Access Com. includes Options EA and EB at no charge, therefore do not order them with this option.

Appendix D - Specifications

Input Specifications

THERMOCOUPLE

TYPE	RANGE	TYPE	RANGE
J	-130 TO 760C -200 TO 1400F	E	0 TO 750C 0 TO 1400F
K	-130 TO 1370C -200 TO 2500F	B	200 TO 1800C 400 TO 3300F
T	-200 TO 400C -330 TO 750F	N	0 TO 1300C 0 TO 2370F
R	200 TO 1650C 400 TO 3000F	C	200 TO 2300C 390 TO 4170F
S	200 TO 1650C 400 TO 3000F		

RTD

100 ohm
(.00385 OHM/OHM/C)
-140 to 400C
-220 to 750F

VOLTS

0 to 5 VDC
1 to 5 VDC

MILLIVOLTS

0 to 25 mVDC
0 to 50 mVDC
10 to 50 mVDC

MILLIAMPS

* 0 to 20 mADC

REMOTE SETPOINT

0 to 5 VDC
1 to 5 VDC

* 4 to 20 mADC is accommodated via the 1-5 VDC with the addition of a shunt resistor.

SENSOR FAULT DETECTION

Displays Hi or Lo process input for thermocouple or RTD inputs (10% above or below range) and sensor break, SnSr. On/Off outputs and proportional outputs go off. Sensor fault detection is not functional for 0 to 5 VDC.

Output Specifications

CONTROL OUTPUT 1 AND 2

Relay Output	SPST 115 VAC: 5.0 A Resistive; 1/8HP or 250 VA 230 VAC: 2.5 A Resistive; 1/8HP or 250 VA
SSR Driver	Open collector output Short circuit protected at 100 mA maximum Provides 4 VDC at 20 mA or 3 VDC at 40 mA
Current Output	0-20mADC or 4-20 mADC into 650 ohms maximum.

ALARM OUTPUT

Relay Output	SPST 115 VAC: 5.0 A Resistive; 1/8HP or 250 VA 230 VAC: 2.5 A Resistive; 1/8HP or 250 VA
SSR Driver	Open collector output Short circuit protected at 100 mA maximum Provides 4 VDC at 20 mA or 3 VDC at 40 mA

Display Specifications

Digital Display Four (4) 7 segment LED's each; .56 inches high

Status Indicators Individual LED indicators for Setpoint, Out 1, Out 2, Manual, Alarm, Degrees F, Degrees C, or Engineering Units, minus sign for negative values

Alarm Adjustment Specifications

Process Alarm	-9999 to 9999 units
Deviation Alarm	-3000 to 3000 units
Deviation Band Alarm	1 to 3000 units

Control Adjustments Specifications

On/Off Hystereels	0 to 300 units
Proportional Band	1 to 3000 units
Manual Reset	-1500 to 1500 units
Auto Reset	0.0 to 100.0 repeats/minute
Rate	0.0 to 10.0 minutes
Cycle Time	1 to 240 seconds
Position Proportioning Sensitivity	0.0 to 50.0 %
First Output Position	-1000 to 1000 units
Spread	-1000 to 1000 units

Performance Specifications

Measurement Error Limit	<ul style="list-style-type: none"> • Type J,K,T,E,N, & C thermocouples and RTD ± 0.25% of reading plus 1 degree at 25 degree C • Type R,S, & B thermocouple ± 0.25% of span at 25C • mVDC, mA DC and VDC ± 0.25% of scaled span plus 1 least significant digit at 25 degrees C
Ambient Temp. Error	0.01% of span per degree C deviation from 25 degrees C
Scan Rate	1 scan per second 3 scans per second with EA Option
Display Resolution	0 to 3 decimal places (depending upon input type selected)
Auto Reset Windup Inhibit	Auto reset is disabled when the process is outside of the proportional band
Cold Junction Compensation	Self compensation for ambient temperature. All calibration values are stored in memory
Noise Rejection	Normal mode, 85dB minimum at 60 Hz or greater. Common mode, 90dB minimum ± 8VDC maximum peak for RTD input, 115 VAC maximum for other inputs
Line Voltage	115/230 VAC ± 10% 50/60 Hz
Power Consumption	15VA maximum
Operating Temperature	0 to 55° C 32 to 131° F
Storage Temperature	-40 to 65° C -40 to 149° F
Humidity	0 to 90% RH, noncondensing
Dimensions	1/4 DIN front panel (96mm X 96mm) 5.8 inches deep
Weight	3 pounds maximum
Vibration	0.5 to 100 Hz at 0.5g
Agency Approvals	UL and CSA pending
Warranty	3 years, see inside back page for more details

Appendix E Software Record/Reference Sheet

Program Mode		EA	EB	Program Mode Continued		Enable Mode				
InPs	ICor			SPrr	CCon	ENAB	ON	OFF		
out1	o1PL			CbS	CAd	EtSt				
out2	o2PL					ECAL				
out3	rLyA					EPro				
rLyb	rLyC					Etun				
diSP	dPoS					ESby				
Euu	EuL					ESPS				
HySt	rSP					ESPC				
rSPu	rSPL									
SPL	SPuL									
SPLL	AtFr									
PFF	dFF									
FScn	Prnd									
Co1r	Co2r									
Pout	Pou									
PoL	PorA									
POAP										
						Tune Mode				
						SPrd				
						PAL				
						dAL				
						dbAL				
						Pb1				
						Pb2				
				rSEt						
				ArSt						
				rAtE						
				Ct1						
				Ct2						
				SEnS						
				FoP						

Warranty and Return Statement

These products are sold by The Anderson Instrument Company (Anderson) under the warranties set forth in the following paragraphs. Such warranties are extended only with respect to a purchase of these products, as new merchandise, directly from Anderson or from an Anderson distributor, representative or reseller, and are extended only to the first buyer thereof who purchases them other than for the purpose of resale.

Warranty

These products are warranted to be free from functional defects in materials and workmanship at the time the products leave the Anderson factory and to conform at that time to the specifications set forth in the relevant Anderson instruction manual or manuals, sheet or sheets, for such products for a period of three years.

THERE ARE NO EXPRESSED OR IMPLIED WARRANTIES WHICH EXTEND BEYOND THE WARRANTIES HEREIN AND ABOVE SET FORTH. ANDERSON MAKES NO WARRANTY OF MERCHANTABILITY OR FITNESS FOR A PARTICULAR PURPOSE WITH RESPECT TO THE PRODUCTS.

Limitations

Anderson shall not be liable for any incidental damages, consequential damages, special damages, or any other damages, costs or expenses excepting only the cost or expense of repair or replacement as described above.

Products must be installed and maintained in accordance with Anderson instructions. Users are responsible for the suitability of the products to their application. There is no warranty against damage resulting from corrosion, misapplication, improper specifications or other operating condition beyond our control. Claims against carriers for damage in transit must be filed by the buyer.

This warranty is void if the purchaser uses non-factory approved replacement parts and supplies or if the purchaser attempts to repair the product themselves or through a third party without Anderson authorization.

Returns

Anderson's sole and exclusive obligation and buyer's sole and exclusive remedy under the above warranty is limited to repairing or replacing (at Anderson's option), free of charge, the products which are reported in writing to Anderson at its main office indicated below.

Anderson is to be advised of return requests during normal business hours and such returns are to include a statement of the observed deficiency. The buyer shall pre-pay shipping charges for products returned and Anderson or its representative shall pay for the return of the products to the buyer.

Approved returns should be sent to:

**ANDERSON INSTRUMENT COMPANY INC.
156 AURIESVILLE ROAD
FULTONVILLE, NY 12072 USA**

ATT: REPAIR DEPARTMENT



ANDERSON INSTRUMENT CO.
156 AURIESVILLE RD.
FULTONVILLE, NY 12072 USA
800-833-0081 • FAX 518-922-8997
www.andinst.com

LATIN AMERICA AND ASIA
Maida International
516-676-3079 • FAX 516-676-3199