

## 2R-SERIES 2R2500 & 2R3500 DOUBLE ACTING & SPRING RETURN SCOTCH YOKE ACTUATORS

### BRIEF INTRODUCTION

TRIAC 2R2500 & 2R3500 scotch yoke actuators have been designed and engineered to provide high cycle-life to meet the demands of our customers. Equipped with dual travel stops and NAMUR accessory mounting.

### !!!WARNING!!!

**FOR YOUR SAFETY, IT IS IMPORTANT THAT THE FOLLOWING PRECAUTIONS BE TAKEN BEFORE ANY DISASSEMBLY OF THE ACTUATOR OCCURS.**

1. Depressurize the lines and cylinder of the actuator before removing any components.
2. On spring return actuators be careful to loosen the end cap bolts evenly due to the preload on the springs.

### Installation of Actuator

Triac actuators are adapted to the valve by means of an intermediate bracket and coupler. The coupler adapts the star output of the actuator to the valve shaft. Standard mounting kits provided for mounting the actuator in the direction of the pipe.

After mounting the actuator, it may be necessary to adjust the travel stops for proper open or closed valve position.

Pneumatically stroke the actuator several times to assure proper operation with no binding of the coupler.

### Air Supply

Pneumatic piping to the actuator and associated accessories should follow the best practices for instrument pneumatic piping systems, I.E. lines free of water, oil, pipe sealant or other contaminants. The operating medium is to be filtered dry air or inert gas which is filtered to 50 micron particles size or less. It is extremely important that the actuator be powered with the proper air pressure and air volume. Maximum working pressure is 150 PSI.

The spring housing on spring return actuators, if not piped, will breathe through the right hand port. It's important that it not be exposed to a corrosive atmosphere. Please contact A-T Controls for possible solutions if this condition exists.

### Lubrication

Triac actuators are factory lubricated for life and additional lubrication is not normally required. However, for actuators performing 100,000 cycles or more, an oil mist lubricator is

recommended. Oil mist lubrication requires a mineral oil type ISO VG32 Class 1 for usage in temperature range 15 to 158 Deg. F. Oil mist lubricator must be set to the lowest setting. Once begun, the oil mist lubrication cannot be discontinued.

### CAUTION

*If the actuator is equipped with a pneumatic positioner or pneumatic controller, oil mist lubricated air cannot be used unless the instrument manufacturer indicates that the instrument is compatible with lubricated air.*

### Orientation of Pistons

#### Double Acting (DA)

The pistons of standard DA actuators are as shown below. This provides for the highest torque at the "closed" valve position for valves that rotate clockwise to close. The pistons are then in their innermost position and the end of travel stop can be fine adjusted + or - 5 degrees (SEE INSTRUCTIONS on page 2).

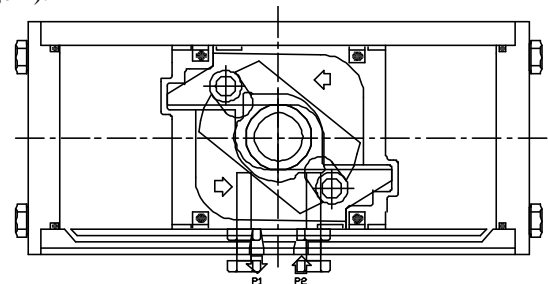

(DL/SAH)

#### Spring Return (SR)

The pistons of standard SR actuators are mounted as shown below. Although spring force is diminished, the geometry of the mechanism provides a greater torque at the end of the spring stroke than at mid stroke. When the actuator is in the "opened" valve position (springs fully compressed), the end of travel stop can be fine adjusted + or - 5 degrees (SEE INSTRUCTIONS on page 2).

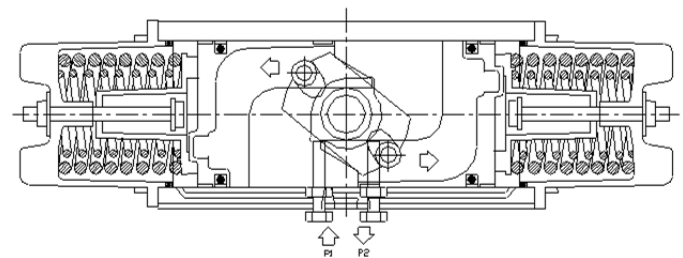

(SAH)

## Travel Adjustment

### !!!WARNING!!!

**TO AVOID CATASTROPHIC FAILURE TO ACTUATOR, AIR MUST BE REMOVED FROM ACTUATOR BEFORE ANY TRAVEL ADJUSTMENTS ARE MADE.**

The + or - 5 degree adjustment of the end of travel stop is accomplished by loosening the lock nut on the center body and turning the adjustment screw clockwise for reduced rotary motion and counterclockwise for increased motion. The spring force or pneumatic force must be relieved before adjusting the travel stops. IE The actuator must be rotated slightly off the stop bolt before adjusting. *It is very important that both travel stops are properly adjusted.*

## Disassembly Procedures

### !!!WARNING!!!

**FOR YOUR SAFETY, IT IS IMPORTANT THAT THE FOLLOWING PRECAUTIONS BE TAKEN BEFORE ANY DISASSEMBLY OF THE ACTUATOR OCCURS.**

1. Depressurize the lines and cylinder of the actuator before removing any components.
  2. On spring return actuators be careful to loosen the end cap bolts evenly due to the preload on the springs.
- 
1. Disconnect electrical supplies and shut off pneumatic supply and vent actuator.
  2. **WARNING:** Do NOT touch the spring bolt (27) This bolt is preset from the factory. Any adjustments could result in injury or death.
  3. Remove end cap bolts (18) on DA, (24) on SR.
  4. Remove end caps (2) on DA, (3) on SR from actuator.
  5. Rotate pinion (4) until the pistons (6) are at the end of the cylinder. This can be done by turning the pinion with a wrench on the flats of the piston.
  6. Remove the piston(s) from the cylinder (1). *See NOTE after step 11.*
  7. Set actuator on its end so the short side of the body is facing upward.
  8. Rotate the pinion until the flat side of the yoke pin (9) is facing upward. (There are two different sides to the yoke pin, flat and a round side, grind off peen)
  9. Take a punch rod and knock out the yoke pin. (Be careful NOT to DAMAGE the yoke (5))
  10. Remove snap ring (15), and washers (13) & (14) from the top of the pinion.
  11. Tap top of pinion *lightly* with a plastic mallet to remove the pinion from the upper (31) and lower drive shaft bushings.
- NOTE: Removal of the pinion and yoke (5) (steps 7-11) is not required for normal maintenance and is not recommended.**

### Changing from "Fail Close" to "Fail Open" 2500

1. Disconnect electrical supplies and shut off pneumatic supply and vent actuator.
2. Remove the eight end cap bolts (24). (14mm hex key wrench)
3. Remove both end caps (3).
4. Loosen travel stop locknut (20).
5. Back out travel stops (21) about six turns so the Stop Cam does not interfere with the travel stop bolts.
6. Mark the piston (6) and body (1) with a black marker to designate placement on how the piston was removed.
7. Rotate the pinion (4) until the piston is at the end of the cylinder. (This can be done by turning the pinion with a wrench on the flats)
8. Remove the piston.
9. Set actuator on its end so the short side of the body is facing upward.
10. Rotate the pinion until the flat side of the yoke pin (9) is facing upward. (There are two different sides to the yoke pin, flat and a round side, grind off peen)
11. Take a punch rod and knock out the yoke pin. (Be careful NOT to DAMAGE the yoke (5))
12. Once the yoke pin is removed, rotate the yoke 180 degrees without letting the pinion rotate.
13. Replace the yoke pin by putting the flat side in first and hitting the pin on the rounded side and peen the flat side.
14. Grease cylinder surface with multi-purpose grease.
15. Rotate the piston 180 degrees from the original position.
16. Ensure the piston roller bearing is properly seated in the yoke for proper alignment.
17. Rotate the pinion 90 degrees counter-clockwise to confirm proper engagement.
18. Set the travel stops.
19. Tighten travel stop locknut.
20. Replace the end caps (Align spring assembly so that one of the four support points falls between the bosses on the piston and pins engage holes in the piston.
21. Tighten bolts to 1,440 in-lbs (14mm hex key wrench)
22. Stroke actuator a couple of times to make sure the travel stops are set correctly and for smooth operation.

### Changing from “Spring Closed” to “Spring Open” 3500

1. Disconnect electrical supplies and shut off pneumatic supply and vent actuator.
2. Remove the eight end cap bolts (24). (14mm hex key wrench)
3. Remove both end caps (3).
4. Loosen travel stop locknut (20).
5. Back out travel stops (21) about six turns so the Stop Cam does not interfere with the travel stop bolts.
6. Mark the piston (6) and body (1) with a black marker to designate placement on how the pistons were removed.
7. Rotate the pinion (4) until the pistons are at the end of the cylinder. (This can be done by turning the pinion with a wrench on the flats)
8. Remove the pistons.
9. Grease cylinder surface with multi-purpose grease.
10. Rotate the pistons 180 degrees from the original position.
11. Ensure the piston roller bearing is properly seated in the yoke (5) for proper alignment.
12. Rotate the pinion 90 degrees Counter-clockwise to confirm proper engagement.
13. Set the travel stops.
14. Replace the end caps (Align spring assembly so that one of the four support points falls between the bosses on the piston and pins engage holes in the piston..)
15. Tighten bolts to 1,440 in-lbs (14mm hex key wrench)
16. Stroke actuator a couple of times to make sure the travel stops are set correctly and for smooth operation.

### Reassembly Procedure

1. Inspect all parts for wear and replace any worn parts as needed. Replace all O-rings.

SEAL KIT			
Temp Range	-65 to +275 F	-15 to +400 F	-45 to +175 F
Size	Nitrile Buna	Fluorocarbon	Low Temperature Buna
2R2500	2BOK2500	VOK2500	LTOK2500
2R3500	2BOK3500	VOK3500	LTOK3500

REPAIR KIT			
Temp Range	-65 to +275 F	-15 to +400 F	-45 to +175 F
Size	Nitrile Buna	Fluorocarbon	Low Temperature Buna
2R2500	2RKB2500	2RKV2500	2RKLT2500
2R3500	2RKB3500	2RKV3500	2RKLT3500

2. Clean all components and lightly grease cylinder bore, and seals with multi-purpose grease.
3. Install piston based on proper orientation.
4. Ensure that pistons are lined up so that roller bearing (8) engages scotch yoke correctly. Once pistons are in, rotate shaft 90 Degrees clockwise to draw pistons in and confirm proper engagement.
5. SR - Align spring assembly so that one of four support points falls between the bosses on the piston and pins engage holes in the piston.
6. DA - Install end caps.
7. Install bolts (18).
8. Tighten locknut (24).
9. The travel adjustment can be accomplished by following the procedure on page 1.

## OPERATION

(Viewed from top of actuator)

### Double Acting

Applying air pressure to port 1 drives the piston(s) outward, which turns the drive shaft *counterclockwise* as the air volume on the outside of the piston(s) exhausts through port 2.

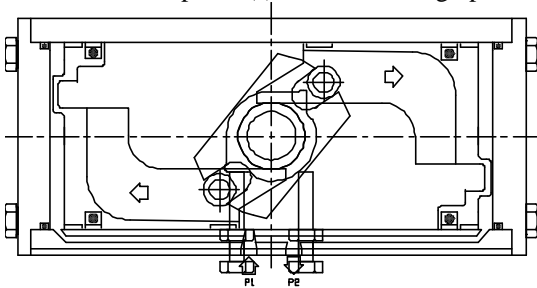

Applying air pressure to port 2 drives the piston(s) inward, which turns the drive shaft *clockwise* as the air exhausts through port 1.

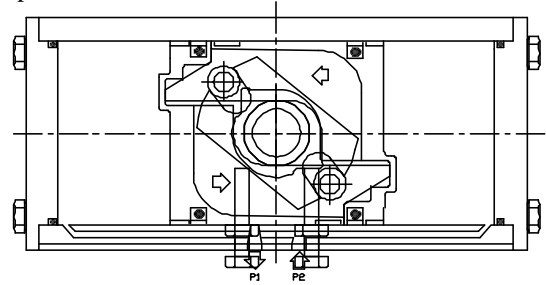

### Spring Return (Fail CW)

Applying air pressure to port 1 drives the pistons outward, which compresses the spring and turns the drive shaft *counterclockwise* as the air volume on the outside of the piston(s) exhausts through port 2.

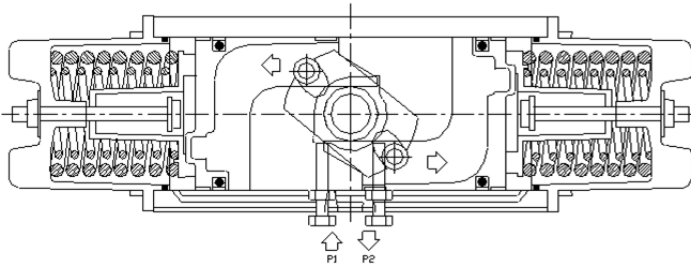

Exhausting the air pressure from port 1 allows stored energy of the spring to drive pistons inward, turning the drive shaft *clockwise*. Air volume on the outside of the pistons vents through port 2.

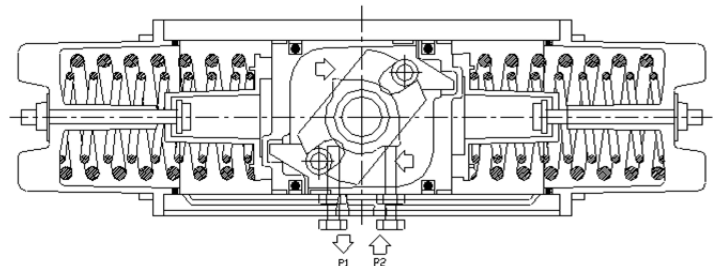

### Spring Return (Fail CCW)

Applying air pressure to port 1 drives the pistons outward, which compresses the spring and turns the drive shaft *clockwise* as the air volume on the outside of the pistons exhausts through port 2.

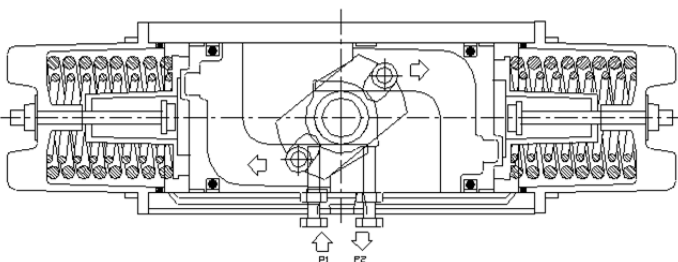

Exhausting the air pressure from port 1 allows stored energy of the spring to drive pistons inward, turning the drive shaft *counterclockwise*. Air volume on the outside of the pistons vents through port 2.

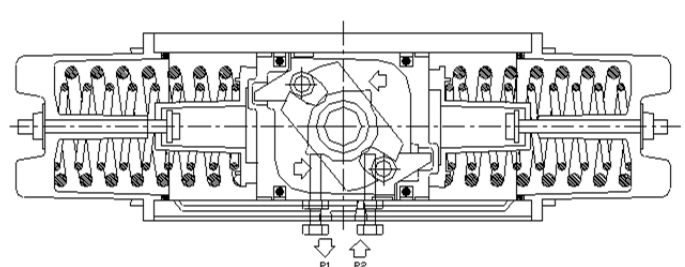

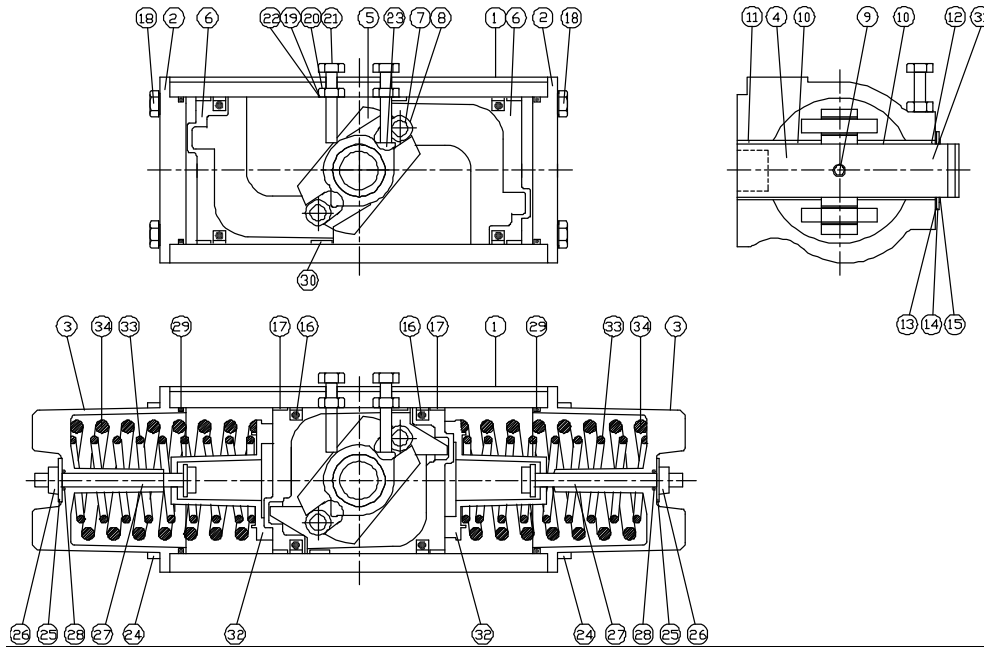

Item No.	Description	Quantity	Quantity	Quantity	Quantity	Material
		2500DA	2500SR	3500DA	3500SR	
1	Actuator Body	1	1	1	1	Hard Anodized Extruded Aluminum
2	DA End cap	2	1	2	--	Epoxy Coated - Aluminum
3	SR End cap	--	1	--	2	Epoxy Coated - Aluminum
4	Pinion	1	1	1	1	Nickel Plated Steel
5	Scotch Yoke	1	1	1	1	Hardened Steel
6	Piston	1	1	2	2	Aluminum
7	Pinion Pin	1	1	2	2	Hardened Steel
8	Roller Bearing	1	1	2	2	Hardened Steel
9	Yoke Pin	1	1	1	1	Hardened Steel
10	Center Bushings ①②	2	2	2	2	Nylon
11	Lower Pinion O-Ring ①②③	1	1	1	1	Nitrile
12	Upper Pinion O-Ring ①②③	1	1	1	1	Nitrile
13	Support Bushing ①②	1	1	1	1	RTFE
14	Support Washer ①②	1	1	1	1	Plated Steel
15	Snap Ring ①②	1	1	1	1	Plated Steel
16	Piston O-Ring ①②③	1	1	2	2	Nitrile
17	Piston Guide Band ①②	1	1	2	2	Nylon
18	End Cap Bolt - DA	8	4	8	--	Stainless Steel
19	Travel Stop Washer	2	2	2	2	Stainless Steel
20	Travel Stop Locknut	2	2	2	2	Stainless Steel
21	Travel Stop Bolt	2	2	2	2	Stainless Steel
22	Travel Stop O-Ring	2	2	2	2	Nitrile
23	Travel Stop Cam	1	1	1	1	Hardened Steel
24	End cap Bolt - SR	--	4	--	8	Stainless Steel
25	Pre-Tensioning Washer - SR	--	1	--	2	Stainless Steel
26	Pre-Tensioning Locknut - SR	--	1	--	2	Stainless Steel
27	Pre-Tensioning Screw - SR	--	1	--	2	Stainless Steel
28	Pre-Tensioning O-Ring - SR	--	1	--	2	Nitrile
29	End Cap O-Ring ①②③	2	2	2	2	Nitrile
30	Wear Band ①②	1	1	2	2	PTFE
31	Top Pinion Bushing ①②	1	1	1	1	Nylon
32	Spring Guide - SR	--	1	--	2	Aluminum
33	Spring Internal - SR	--	1	--	2	Spring Steel
34	Spring External - SR	--	1	--	2	Spring Steel

- ① Recommended Spare Parts
- ② Parts Included in a Repair Kit
- ③ Parts Included in a Seal Kit

*A-T Controls product, when properly selected, is designed to perform its intended function safely during its useful life. However, the purchaser or user of A-T Controls products should be aware that A-T Controls products might be used in numerous applications under a wide variety of industrial service conditions. Although A-T Controls can provide general guidelines, it cannot provide specific data and warnings for all possible applications. The purchaser / user must therefore assume the ultimate responsibility for the proper sizing and selection, installation, operation, and maintenance of A-T Controls products. The user should read and understand the installation operation maintenance (IOM) instructions included with the product, and train its employees and contractors in the safe use of A-T Controls products in connection with the specific application.*

*While the information and specifications contained in this literature are believed to be accurate, they are supplied for informative purposes only. Because A-T Controls is continually improving and upgrading its product design, the specifications, dimensions and information contained in this literature are subject to change without notice. Should any question arise concerning these specifications, the purchaser/user should contact A-T Controls.*

For product specifications go to <http://download.a-tcontrols.com/>

A-T Controls, Inc. • 9955 International Boulevard, Cincinnati, OH 45246 • Phone: (513) 530-5175 • Fax: (513) 247-5462 • [www.a-tcontrols.com](http://www.a-tcontrols.com)