



TEK-FLEX 4100C

Programmable Two-wire TDR Level Transmitter With Hart & Display

Instruction Manual

Document Number: IM-4100C



www.tek-trol.com

NOTICE

Read this manual before working with the product. For personal and system safety, and for optimum product performance, make sure you thoroughly understand the contents before installing, using, or maintaining this product.

For technical assistance, contact

Customer Support

796 Tek-Drive

Crystal Lake, IL 60014

USA

Tel: +1 847 857 6076, +1 847 655 7428

© COPYRIGHT Tek-Trol LLC 2019

No part of this publication may be copied or distributed, transmitted, transcribed, stored in a retrieval system, or translated into any human or computer language, in any form or by any means, electronic, mechanical, manual, or otherwise, or disclosed to third parties without the express written permission. The information contained in this manual is subject to change without notice.

Table of Contents

1	Measurement Principle	2
1.1	Principle	2
2	Product Overview.....	3
2.1	Features	3
3	Mounting Requirement	4
3.1	Basic Requirement for Installation	4
3.1.1	Illustration.....	4
3.1.2	Stand Pipe	5
3.1.3	Mounting	5
3.1.4	Horizontal and Vertical Installation	6
4	Electrical Connections.....	7
4.1	Power Supply	7
4.2	Cable Connection.....	7
4.3	Wiring Diagram	7
5	Adjustment Instructions	8
5.1	Adjustment Method	8
5.1.1	Display/Adjustment Module.....	8
5.1.2	Connect with another unit through HART	9
5.1.3	HART Handheld Programmer	9
6	Dimensions	10
7	Technical Specifications	11
7.1	2-Wire Load Resistance Diagram	11
7.2	Accuracy Curve	12
7.3	Pulling Force.....	12
8	Menu Tree.....	13

1 Measurement Principle

1.1 Principle

High frequency microwave pulses travels along the detecting component (steel rope or rod) and reflects when reaching the product surface. The time from emission to reception is proportional to the distance between the surface and the reference plane on the instrument.



2 Product Overview



2.1 Features

- Wire-loop-powered level meter with HART
- Measuring range up to 60'
- Local display and push button on programming
- Probes and process connections are made of stainless steel
- For process temperature up to 302°F and pressure up to 580 psig
- Not affected foam, vapor or mist

3 Mounting Requirement

3.1 Basic Requirement for Installation

Keep in mind that the cable/rod is kept away from obstructions within vessel. The obstructions like: ladders, limit switches, heating spirals, struts and etc. Further more, rope or rods must not intersect the filling streams.

Be cautious during the installation: the level of the measured cable medium must not be in the blanking zone the mounting location must keep a min distance to the vessel wall, the cable or rod is perpendicular to the surface of the measured medium.

3.1.1 Illustration

The reference plane is the thread or flange surface

1 Blanking Zone (Menu 1.10) F

2 Length (Menu 1.9)

3 Max. Measurement Range (Menu 1.2)

4 Min. Measurement Range (Menu 1.1)

5 Reference plane

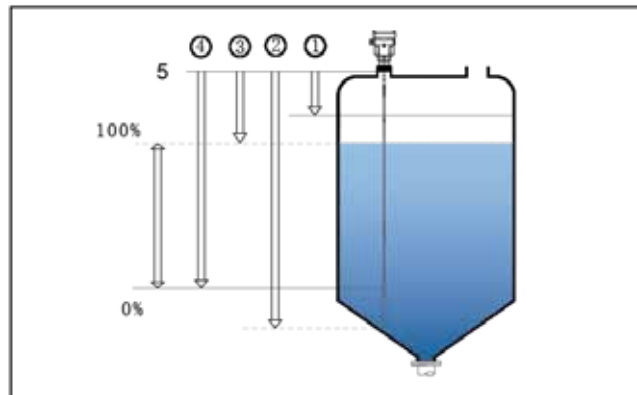

Note: The level of the measured medium must not be in either the blanking zone.

The best mounting location for a conical vessel with flat top is the centre of the vessel's top, as the effective measurement can reach the bottom of vessel.

3.1.2 Stand Pipe

Avoid installation with socket if possible, otherwise try to minimize the length of socket. In case of long stand pipe, small vessel or medium with low dielectric constant.

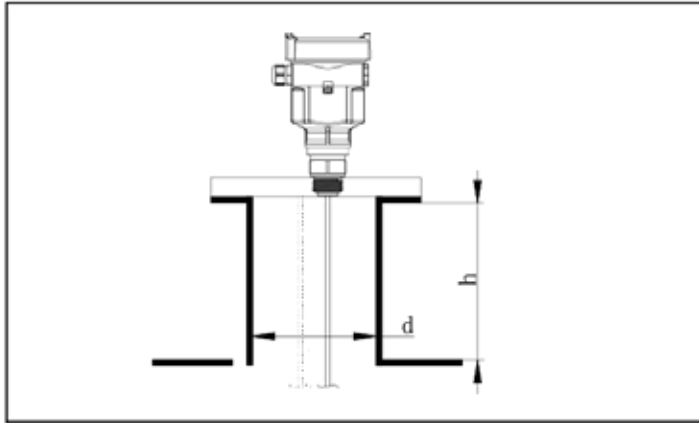

3.1.3 Mounting

1 Wrong: The rod/rope is in/above filling stream, which results in the measurement of filling stream not the target medium.

2 Correct

Note: Sun shield or rain-proof is suggested for outdoor mounting.

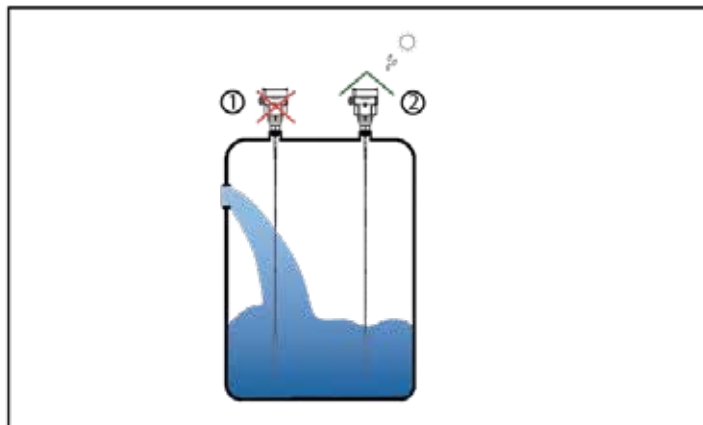

3.1.4 Horizontal and Vertical Installation

When mounting outdoors, humid indoors or on cooling/heating vessels, in order to avoid damp seal rings used on cables should be screwed tight, and the cable must be bended downward outside cable entry, as indicated on the diagram below:

4 Electrical Connections

4.1 Power Supply

Power supply and current signal are carried by the same two-wire connection cable. See the Technical Specifications of this guide for detailed requirement on power supply.

4.2 Cable Connection

The two ends of shielded cable must be connected with earth terminal. The shielded cable must be connected with inner earth terminal directly inside the transducer, while the outside earth terminal on housing must be connected with ground. In the event of earth-connected current, the shielding side of shielded cable must be connected to ground potential via a ceramic capacitor (e.g.: $1\mu\text{F}$ 1500V) in order to dampen the low frequency grounding current and avoid the disturbance caused by high frequency signals

4.3 Wiring Diagram

2 Wire

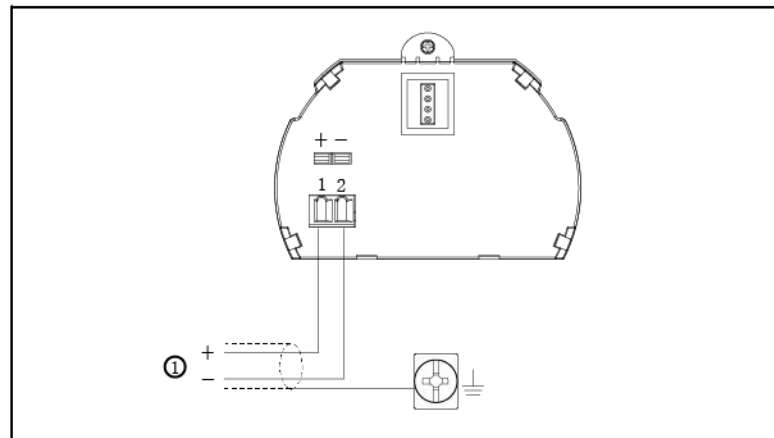

5 Adjustment Instructions

5.1 Adjustment Method

Three methods are available for Guided Wave Radar adjustment:

- Display/adjustment module Tek Point
- Connect with another unit through HART
- HART handheld programmer

Use the operation panel of the transmitter to set the configuration parameters such as the zero calibration, cut-off value of low flow and output range of current frequency, etc.

5.1.1 Display/Adjustment Module

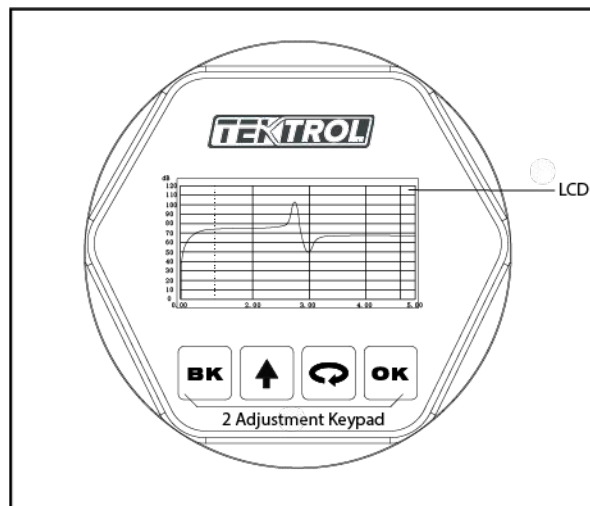

[OK] Keypad

- Enter programming mode
- Confirm programming options
- Confirm modifications to parameters

[↻] Keypad

- Choose programming options
- Choose the digit of parameters to edit
- Display the contents of parameters

[↑] Keypad

- Modify parameter values

Shortcut

[BK] Keypad

- Programming mode exit
- Return to higher menu level

[BK] Display Echo wave

5.1.2 Connect with another unit through HART

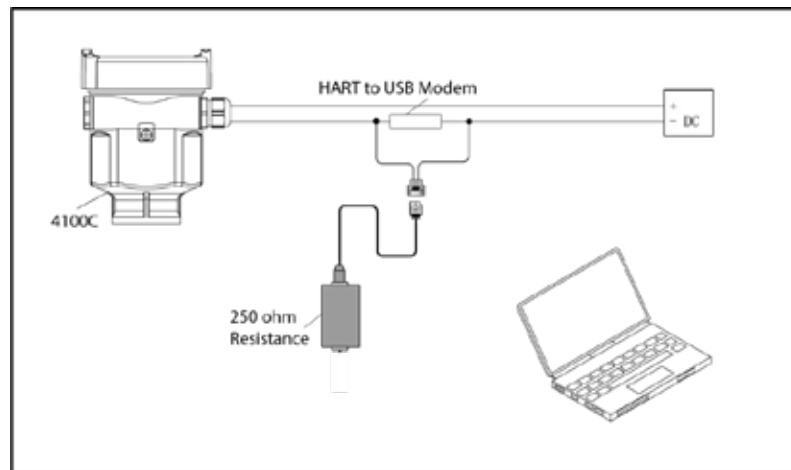

5.1.3 HART Handheld Programmer Adjust 4100C with HART Handheld Programmer

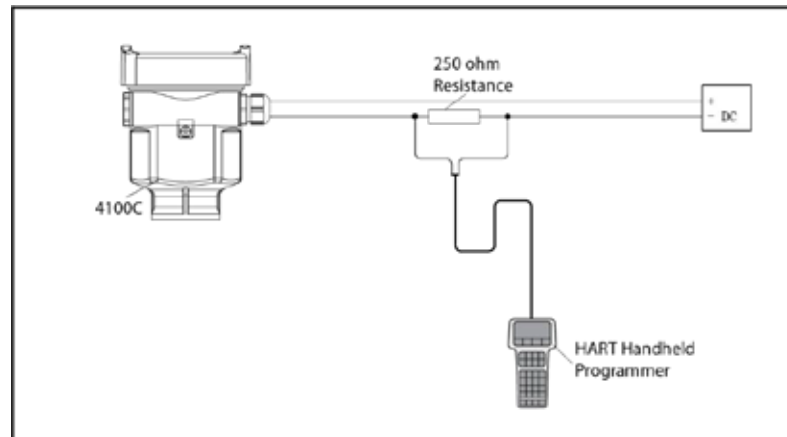

6 Dimensions

Tek-Flex 4100C Two Wire TDR Level Transmitter with HART

7 Technical Specifications

Application	Compatible Liquids and Solids
Wetted Material	316 L SS and Kalrez
Measuring Principle	TDR (Time Domain Reflectometry)
Ranges	Up to 60 ft
Accuracy	± 0.4"
Process Pressure	-14.5 to 580 psi
Process Temperature	-40 to 302°F (-40 to 150°C)
Process Connection	1.5" Male NPT
Protection Category	NEMA 4X, IP 66
Housing	Epoxy Coated Aluminum
Cable Entry	Two ½ NPT
Power Supply	16 to 36 VDC
Power Consumption	22.5 mA
Damping	0 to 40 seconds
Output Signal	4 to 20 mA with HART (2 wire)
Minimum Dielectric Constant	0.3
User Interface Options	LCD Display

7.1 2-Wire Load Resistance Diagram





7.2 Accuracy Curve

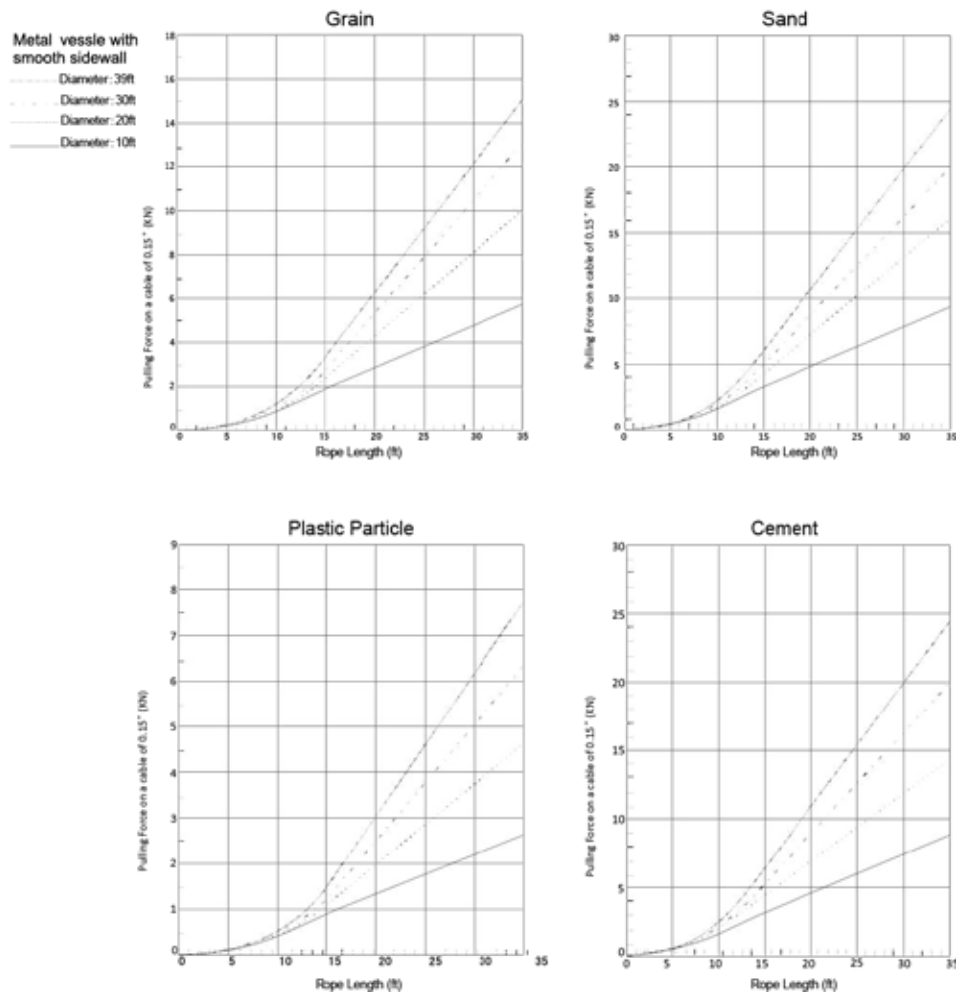

7.3 Pulling Force

When measuring solid medium, the pulling force is determined by the diameter of vessel and medium level, some examples of pulling force generated by typical medium are shown on the diagrams below.









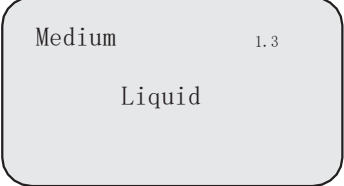
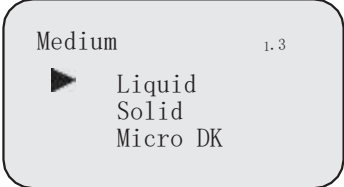
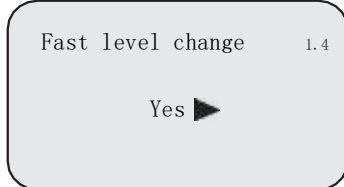
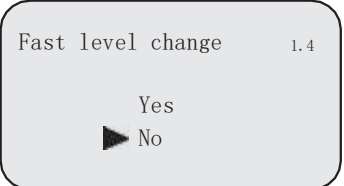
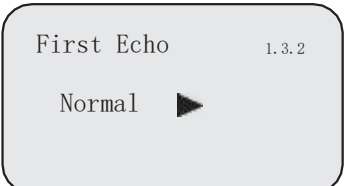
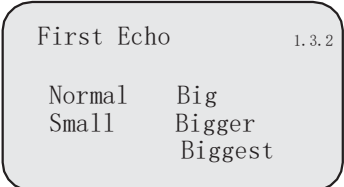

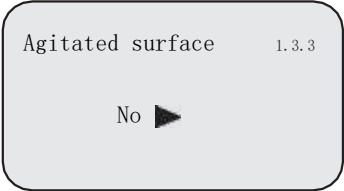
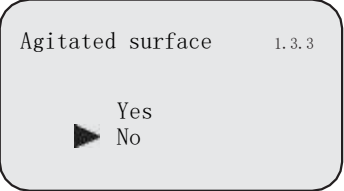
8 Menu Tree

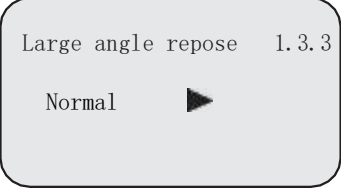
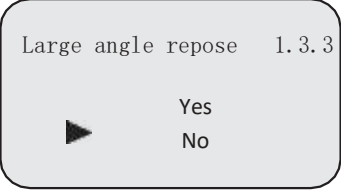
Program instruction	Adjustments parameter settings and testing can be done by the four keys on View Point.
Program Menu Structure	Menu Structure is shown in the appendix. Turn to next menu item pointed by right arrow with OK . Turn to next menu item pointed by down arrow with  . Turn to left item with BK .
Program Submenu	
Basic settings	Basic adjustment for the Sensor are included in this menu. They are min. adjustment, max. adjustment, medium, damping time, Mapping curve, scaled units, scaling, near blanking and sensor tag.
Display	In this menu you can setup the sensor display mode and adjust B/ W contrast for LCD.
Diagnostic	In this menu you can check and test the sensor. You can view the measurement peak values measurement status, echo- curve and simulation.
Service	In this menu you can store false echo curve and current output , units of measurement, language, rest HART operation mode, copy sensor data and PIN.
Info	The information of sensor including sensor type, serial number, date of manufacture, software version.
Program operation	Enter program mode by press OK . Press OK after each parameter editing. Otherwise the modification will be abandoned. Press BK to quit program status.
Parameters editing	
Parameter editing	The first digit of the edited parameter will be displayed in black background on entering parameter editing. Modify the digit with  . Then you can edit next digit with  . After editing, press OK to confirm and store the modification.
Optional item programming	Some settings can be done by selecting one of several optional items with  and confirming with OK .

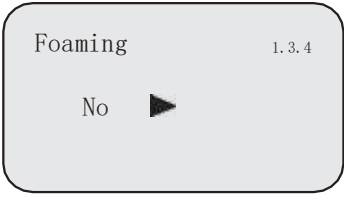
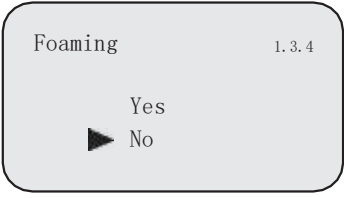

Program menu instruction	
<p>1 Basic settings</p>	<p>Basic settings are basic setup of the sensor, such as min/ max adjustment, medium, damping and etc. To bring the sensor to program mode from run mode, press OK. Then the menu is displayed as below</p> <div data-bbox="522 380 862 569" style="border: 1px solid black; border-radius: 10px; padding: 10px; margin: 10px 0;"> <p>▶ Basic settings 1 Display Diagnostics Service Info</p> </div> <p>Note :The menu item number is displayed on the top right corner.</p>
<p>1.1 Min. adjustment</p>	<p>The item is one of the two setting points that regulates the linear scaled current output. At main menu(the menu number is 1). Select Basic settings with  and confirm with OK. Now the Min. Adjustment is displayed on LCD. the menu item number is 1.1.</p> <div data-bbox="522 848 862 1037" style="border: 1px solid black; border-radius: 10px; padding: 10px; margin: 10px 0;"> <p>Min adjustment 1.1 0.00% 35.000 ft (d 1.346 ft (d</p> </div> <p>Press OK, you can edit the percentage value. Press OK again, you confirm the modification, and further more you can edit the corresponding distance value. See parameter edition to learn how to edit parameters.</p>
<p>1.2 Max. adjustment</p>	<p>The item is one of the two setting points that regulates the linear scaled current output. Pushing  enter this menu when the menu item number is 1.1. LCD displays as below</p> <div data-bbox="522 1346 862 1535" style="border: 1px solid black; border-radius: 10px; padding: 10px; margin: 10px 0;"> <p>Max adjustment 1.2 100.00% 0.000 ft (d 1.409 ft (d</p> </div> <p>Press OK, you can edit the percentage value. Press OK again, you confirm the modification, and further more you can edit the corresponding distance value. See parameter edition to learn how to edit parameters.</p>
<p>1.3 Medium</p>	<p>When LCD menu is 1.2, press ■ to enter edit Medium property, LCD displays as below. There are three options to choose from, Liquid, Solid, and Micro DK. By setting the property of the medium, measurement can be made accurately.</p>

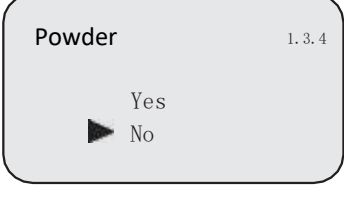

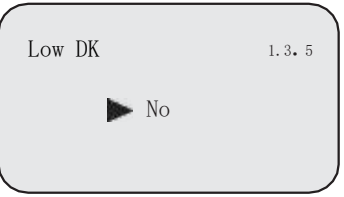

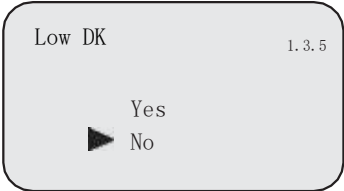
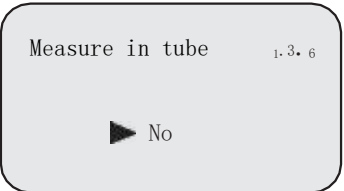
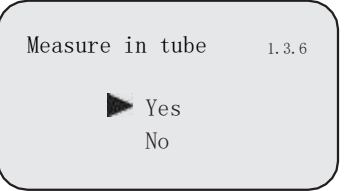
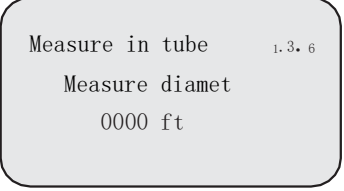
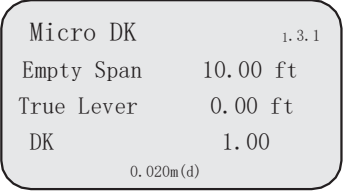

	 
<p>1.3.1 Fast level change</p>	<p>Pushing OK will enter this menu when it is liquid or solid selection menu and menu item number is 1.3. LCD displays as below</p>  <p>Push OK enter Fast level change confirmation. LCD displays as below</p> 
<p>1.3.2 First Echo</p>	<p>When medium is chosen as liquid or solid, LCD menu is 1.3.1, press ↶ to choose next menu. LCD displays as below</p>  <p>Press OK to enter First Echo menu. LCD displays as below</p>  <p>Press ↶ to choose the way to set First echo. There are five ways</p>



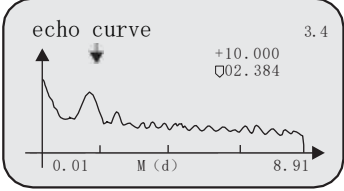

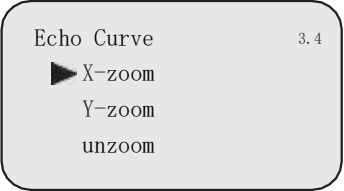

<p>1.3.3 (Liquid)</p>	<p>Normal: No adjustments on first echo Small: Decrease first echo by 10dB Big: Increase first echo by 10dB Bigger: Increase first echo by 10dB Biggest: Increase first echo by 40dB</p> <p>When measure medium is liquid, LCD menu is 1.3.2, press  to choose next menu and enter Agitated surface. LCD displays as below</p>  <p>Press OK to enter Agitated surface menu.</p> 
<p>1.3.3.1 (Solid) Large</p>	<p>When measure medium is solid, LCD menu is 1.3.2, press  to choose next menu and enter Large angle repose. LCD displays as below:</p>  <p>Press OK to enter Large angle repose menu</p> 

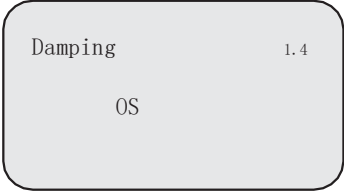

<p>1.3.3.2 (Liquid) Foaming</p>	<p>Pushing  will enter this menu when the menu item number is 1.3.3 . LCD displays as below</p>  <p>Push OK, enter the submenu of Foaming/Powder dust confirmation. LCD displays as below</p> 
<p>1.3.4 (Solid) Powder dust</p>	<p>Pushing  will enter this menu when the menu item number is 1.3.3 . LCD displays as below</p>  <p>Push OK, enter the submenu of Foaming/ Powder dust confirmation. LCD displays as below</p> 
<p>1.3.5 Low DK</p>	<p>Pushing  will enter this menu when the menu item number is 1.3.4 . LCD displays as below</p>  <p>Push OK, enter the submenu of Low DK confirmation. LCD displayed below</p>

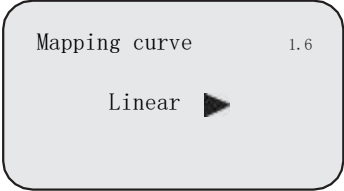

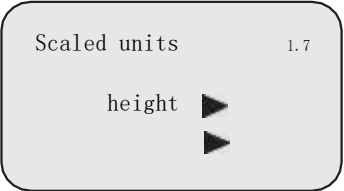

	 <p>Move arrow with ← to Select Yes or No for medium with Low DK. Then confirm with OK.</p>
<p>1.3.6 Measuring in tube</p>	<p>When measurement is carried through a tube, that is limited for the liquid medium, the tube diameter must be set in menu Measure in tube so as to rectify the measuring error.</p> <p>Pushing ← will enter this menu when the menu item number is 1.3.5 . LCD displays as below</p>  <p>Push OK, enter the submenu of Measure in tube confirmation. LCD displays as below</p>  <p>If the selection Yes is confirmed by OK, the diameter of the tube will be required. LCD displays as below</p>  <p>Press OK, the value can be edited.</p>
<p>Micro DK</p>	<p>When choose Micro OK as medium property, press OK to enter Micro DK setting.</p> 



	<p>Normally when electronic constant is smaller than 1.4, the direct echo from the medium is low and hard to detect. However by measuring the echo reflected from the base of the vessel, the height of the medium can be measured. Two parameters are needed to be entered here.</p> <p>1. Height of empty vessel. 2. True medium height or medium electronic constant, these two parameters are related, entering either one is accepted. The precision of parameters will affect the precision of the measurement.</p> <p>Notes: it should be taking cautions while applying the function, Micro DK. When applying this function the system will decide whether use direct echo or echo from the base to take the measurement.</p>
<p>Meas. Status (measure)</p>	<p>Pushing  to display measuring status when the menu item is 3.1. LCD displays as below</p> <div data-bbox="516 856 857 1045" style="border: 1px solid gray; border-radius: 10px; padding: 10px; background-color: #f0f0f0;"> <pre>Meas status 3.2 meas reliability: 10dB sensor status: OK</pre> </div>
<p>Choose curve (echo curve)</p>	<p>At this menu, different curves can be selected to be displayed at menu 3.4, when the menu item is 3.2 press  you get</p> <div data-bbox="516 1218 857 1407" style="border: 1px solid gray; border-radius: 10px; padding: 10px; background-color: #f0f0f0;"> <pre>Choose curve 3.3 echo curve ▶</pre> </div> <p>Pushing OK to select the curve. There are three curves: echo curve, False echo curve and Output trend curve.</p> <div data-bbox="516 1543 857 1732" style="border: 1px solid gray; border-radius: 10px; padding: 10px; background-color: #f0f0f0;"> <pre>Choose curve 3.3 ▶ echo curve false echo curve output trend</pre> </div>

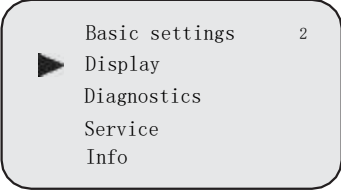
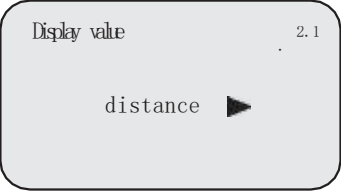
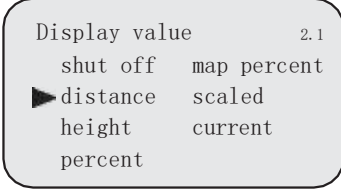

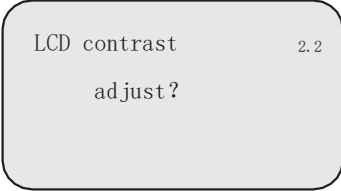
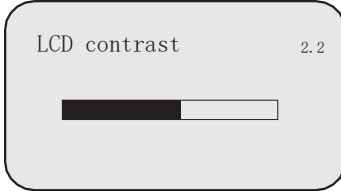
<p>Curve</p>	<p>Pushing  will display the selected curve when the menu item is 3.3. LCD displays as below</p> <p>Curve zoom</p> <p>When the curve is displayed, pushing OK will enter Curve Zoom function menu.</p>  <p>Move arrow with  select menu item for X/ Y axis zoom or un zoom. Then Confirm with OK.</p> <p style="text-align: center;">OK </p> <p>For X axis zoom pushing  to mark the start position for zoom, then confirm with OK. Pushing  again to mark the end position for zoom and confirm with OK. The selected area of the curve will be shown on the whole screen. Exit zoom with BK.</p> 
<p>Simulation</p>	<p>Simulation is used to simulate the 4~20mA current output. By current output simulation the accuracy and linearity of the current output can be checked. And the system testing can be carried out. Push to enter  Simulation menu when the menu item number is 3.4 . LCD displays as below</p>



<p>Damping</p>	<p>Pushing  will enter this menu when the menu item number is 1.3 . LCD displays as below</p>  <p>Press OK, enter editing menu. See parameter edition to learn how to edit the parameter. To confirm the modification with OK, give up with BK.</p>
<p>Mapping curve</p>	<p>This menu define the correlation between the measured value and the current output. linear or non-linear mapping can be selected in this menu. For the non-linear correlations, parameters setting must be done by a computer previously. Pushing  will select this menu when the menu item number is 1.4. LCD displays as below</p>  <p>Press OK, enter editing menu. Move arrow with  to Select linear or non-linear . Then confirm with OK.</p>
<p>Scaled units</p>	<p>The unit of the scaled output value can be set in this menu. Pushing  will enter this menu when the menu item number is 1.5. LCD displays as below</p>  <p>Pushing OK to enter the editing menu then move arrow with  to select the measure word and corresponding unit, confirm by OK.</p>



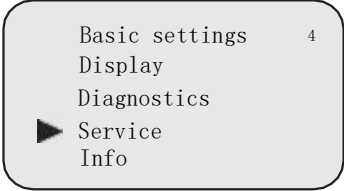
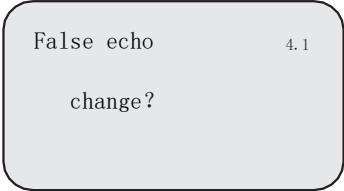
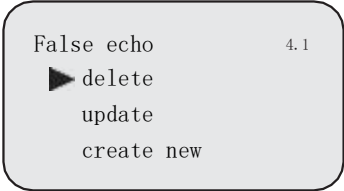

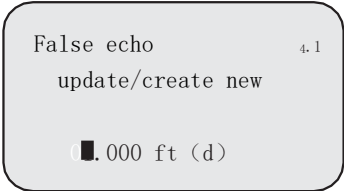
<p>Scaling</p>	<p>Used for linear scaled output to set the linear mapping values. Pushing  will enter this menu when the menu item number is 1.6. LCD displays as below</p> <div data-bbox="532 331 868 520" style="border: 1px solid gray; border-radius: 10px; padding: 10px; margin: 10px 0;"> <pre>Scaling 1.8 0%= 0.00 ft 100%= 0.00 ft</pre> </div> <p>Pushing OK to enter the editing menu, see parameter editing for the value editing. Press OK to confirm the modification.</p>
<p>Sensor length</p>	<p>In order to get correct result, the length of sensor (cable or stick) should be measured first. When LCD menu no. is 4.7, push  to enter sensor length menu. LCD displays as below.</p> <div data-bbox="519 745 857 934" style="border: 1px solid gray; border-radius: 10px; padding: 10px; margin: 10px 0;"> <pre>Sensor Length 1.9 5.000m (d)</pre> </div> <p>Push OK to set sensor length. Re.p2. parameter editing. After editing, push OK to confirm or push BK to quit.</p>
<p>Near blanking</p>	<p>The Near blanking is an area near the antenna where the correct measurement is impossible. The default value is the minimum set by the manufacture.</p> <p>Press  to enter menu Near blanking when the menu item number is 1.7. See parameter editing to edit the near blanking value and then confirm the modification with OK.</p> <div data-bbox="519 1333 857 1522" style="border: 1px solid gray; border-radius: 10px; padding: 10px; margin: 10px 0;"> <pre>Near blanking 1.10 0.400 ft (d)</pre> </div>
<p>Sensor tag</p>	<p>In the menu Sensor TAG you edit a 11-digit measurement loop designation. The character set comprises: Letters from A-Z and Numbers from 0-9.</p> <div data-bbox="516 1633 854 1822" style="border: 1px solid gray; border-radius: 10px; padding: 10px; margin: 10px 0;"> <pre>Sensor tag 1.11 SENSOR</pre> </div> <p>See Optional item programming to edit the tag name.</p>

<p>Display</p>	<p>This menu is used to set display mode. Pushing  will select this menu when the main menu item number is 1. LCD displays as below</p>  <p>Push OK, you get</p>
<p>Display value</p>	<p>Enter display mode set with OK, LCD displays as below</p>  <p>Push OK, you can select different display types of the measured value as shown below</p>  <p>Move arrow to point to the type you want, confirm it with OK.</p>
<p>LCD contrast adjustment</p>	<p>Pushing  will enter this menu when the menu item is 2. 1. LCD display as below</p>  <p>Adjust the B/W contrast by pressing OK, LCD Displays as below</p>  <p>Increase contrast with , decrease contrast with . Confirm with OK.</p>



<p>Diagnostics</p>	<p>The running status of the sensor can be provided by the menu Diagnostics, and further more sensor testing can be done.</p> <p>Pushing  to select this menu when the main menu item number is 2. LCD displays as below</p> <div data-bbox="511 394 852 583" style="border: 1px solid gray; border-radius: 10px; padding: 10px; background-color: #f0f0f0;"> <pre> Basic settings 3 Display ▶ Diagnostics Service Info </pre> </div> <p>Push OK, you get</p>
<p>Peak values</p>	<p>Peak values record the maximum and minimum distance. The records can be cleared to zero at menu 4.4.</p> <div data-bbox="511 787 889 976" style="border: 1px solid gray; border-radius: 10px; padding: 10px; background-color: #f0f0f0;"> <pre> Peak values 3.1 distance-min 0.000 ft (d) distance-max 2.109 ft (d) </pre> </div> <div data-bbox="511 997 857 1186" style="border: 1px solid gray; border-radius: 10px; padding: 10px; background-color: #f0f0f0;"> <pre> Simulation 3.5 start simulation ▶ </pre> </div> <p>Pushing OK enter Simulation mode selection menu . LCD displays as below</p> <div data-bbox="511 1312 857 1501" style="border: 1px solid gray; border-radius: 10px; padding: 10px; background-color: #f0f0f0;"> <pre> Simulation 3.5 ▶ percent current distance </pre> </div> <p>Pushing  select the Simulation mode. Then confirm with OK. The corresponding value will be required and then simulation starts.</p> <p>Three types of simulations</p> <p>Percent : the output current is decided by a percent value : 100% is relative to 20mA, 0% is relative to 4mA.</p> <p>Current: the output current is regulated by a current value.</p>

	<p>Distance: the output current is decided by a distance value .The current output depends on Min. adjustment (see 1.1) , Max adjustment (see 1.2) and Mapping (see 1.5)</p>
<p>Service</p>	<p>This menu with professional functions can only be used by trained technicians. They are False echo storage, Reset, sensor settings back up Password setting and etc.</p> 
<p>False echo</p>	<p>High sockets or vessel installations, e.g. struts or agitators as well as build up and weld joints on the vessel walls cause interfering reflections which can impair the measurement. A false echo storage detects and marks these false echoes, so that they are no longer taken into account for the level measurement. A false echo memory should be created with empty vessel so that all potential interfering reflections will be detected.</p> <p>Pushing OK will enter this menu when the menu item is 4.1 LCD displays as below.</p>  <p>Then push OK displays as below</p>  <p>With  select Update/Create new/Delete a false echo, confirm with OK.</p> 

	<p>When you select update create / new, you are asked to input a distance value for the real echo. Then push OK to confirm it and to start the operation. It will take some time to store the false echo.</p> <p>Note : Check the distance to the product surface. Because if an incorrect (too large) value is entered, the existing level will be saved as false signal. The filling level would then no longer be detectable in this area.</p>
<p>Current output</p>	<p>Setup the current output mode.</p> <p>Pushing  will enter this menu when the menu item is 4.1 LCD displays as below</p> <div data-bbox="516 640 857 835" style="border: 1px solid gray; border-radius: 10px; padding: 5px; background-color: #f0f0f0;"> <p>Current output 4.2 output mode: 4-20mA ▶ failure mode: no change ▶ min current: 4mA ▶</p> </div> <p>With OK you get.</p> <div data-bbox="516 907 857 1096" style="border: 1px solid gray; border-radius: 10px; padding: 5px; background-color: #f0f0f0;"> <p>Current output 4.2 ▶ output mode failure mode min current</p> </div>
<p>Output mode</p>	<p>Select output current as 4-20mA or 20-4mA. 4-20mA mean the Min. level is corresponding to 4mA and the Max. level is corresponding to 20mA. 20-4mA mean the Min. Level is corresponding to 20mA and the Max. level is corresponding to 4mA. When the arrow points at output mode, push OK you get.</p> <div data-bbox="516 1327 857 1516" style="border: 1px solid gray; border-radius: 10px; padding: 5px; background-color: #f0f0f0;"> <p>output mode 4.2 ▶ 4-20mA 20-4mA</p> </div> <p>Push , you select the item you want and confirm with OK.</p>

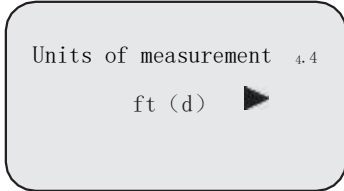
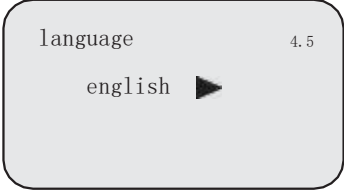
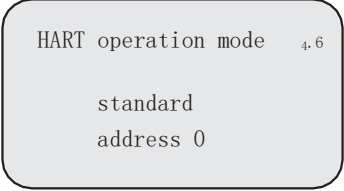
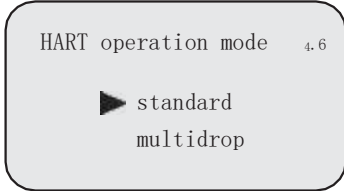

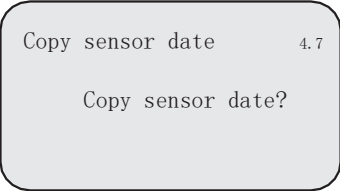
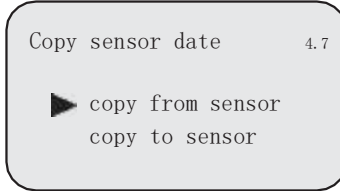
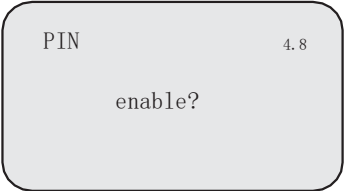
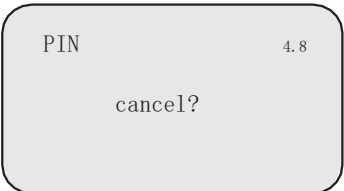

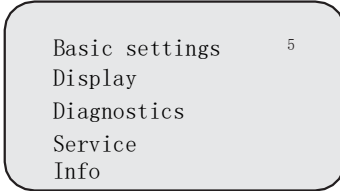



<p>Failure mode</p>	<p>Setup the output current on sensor error. Three status are available. When the arrow points at output mode, push , you get item failure mode and confirm with OK you get.</p> <div data-bbox="516 344 857 533" style="border: 1px solid black; border-radius: 10px; padding: 10px; background-color: #f0f0f0;"> <p>output mode 4.2</p> <p>▶ no change 20.5mA 22.0mA</p> </div>
<p>Min. current</p>	<p>Setup the minimal output current is 4mA or 3.8mA. When the arrow points at fail mode push , you get min. current menu. Confirm with OK you get.</p> <div data-bbox="516 688 857 877" style="border: 1px solid black; border-radius: 10px; padding: 10px; background-color: #f0f0f0;"> <p>min current 4.2</p> <p>▶ 3.8mA 4mA</p> </div> <p>Select the item you want with  and confirm with OK.</p>
<p>Reset</p>	<p>With the reset function, modified settings are reset. Three subfunctions are available: Basic settings</p> <ul style="list-style-type: none"> -Reset settings modified with View Point to the default values. Factory settings -Reset special settings as well as basic settings to default values. <p>Peak measured values</p> <ul style="list-style-type: none"> -Reset the min./max. level records. <p>When the menu item is 42, push , you get.</p> <div data-bbox="522 1352 863 1541" style="border: 1px solid black; border-radius: 10px; padding: 10px; background-color: #f0f0f0;"> <p>Reset 4.3</p> <p>Select reset ▶</p> </div> <p>Push OK, LCD display as below</p> <div data-bbox="513 1617 854 1806" style="border: 1px solid black; border-radius: 10px; padding: 10px; background-color: #f0f0f0;"> <p>Reset 4.3</p> <p>Basic adjustment Factory setting Peak values menu</p> </div> <p>Select the item with . Confirm with OK.</p>

<p>Units of measure</p>	<p>Two sets of measure system units are available. The metric system and the British system.</p>  <p>Push OK, to edit it.</p>
<p>Language</p>	<p>In this menu you can change the language. English and Chinese are available.</p>  <p>Push OK, to change it.</p>
<p>HART operation mode</p>	<p>HART offers standard and multidrop mode .The standard mode with the fixed address 0 means output of the measured value as 4...20 mA signal. In multidrop mode, up to 15 sensors can be operated on one two-wire cable.</p> <p>In this menu you determine the HART mode and enter the address for multidrop.</p>  <p>Push OK, you can select HART operation mode.</p>  <p>The default setting is standard mode with address 0.</p>

<p>Copy sensor data</p>	<p>In this menu you can back up the sensor settings so as to restore them when necessary.</p>  <p>Copy sensor date 4.7 Copy sensor date?</p> <p>Push OK, LCD display below</p>  <p>Copy sensor date 4.7 ▶ copy from sensor copy to sensor</p> <p>Copy from sensor means to save the sensor settings and copy to sensor means to restore the sensor settings.</p>
<p>PIN</p>	<p>In this menu, the PIN is activated/inactivated permanently. Entering a 4-digit PIN protects the sensor data against unauthorized access and unintentional modifications.</p>  <p>PIN 4.8 enable?</p> <p>Or</p>  <p>PIN 4.8 cancel?</p>
<p>Info</p>	<p>In this menu the most important sensor information can be displayed: Sensor type, e.g. GDRD51</p> <p>Serial number: 6-digit number, e.g. 123456 Date of manufacture, e.g. 2006-01-01 Software version, e.g. 06.08.28</p> <p>Pushing  will select this menu when the main menu item number is 4. LCD displays as below</p>  <p>Basic settings 5 Display Diagnostics Service Info</p>

	<p>Then pushing OK enter the Info display menu. LCD displays as below</p> <div style="border: 1px solid black; border-radius: 10px; padding: 10px; background-color: #f0f0f0;"><p>sensor type 5.1 4100C</p><p>serial number 123456</p></div> <p>Pushing  LCD display as below</p> <div style="border: 1px solid black; border-radius: 10px; padding: 10px; background-color: #f0f0f0;"><p>date of manufacture 5.2 2006-01-01</p><p>software version 06.06.28</p></div>
--	--

Example: To display echo curve do as follow:

1. Push **OK** to enter program status. Main menu is displayed on LCD.
2. Push  twice to select Diagnostics submenu item.
3. Push **OK** to enter the submenu menu number is 3.1.
4. Push  to enter next menu, the menu number is 3.2.
5. Push  again ,the menu number is 3.3.
6. Push **OK** to enter the curve select menu (3.3).
7. Set arrow to point to Echo Curve with .
8. Push **OK** to confirm.
9. Push , the echo curve will be shown. Menu number is 3.4.
10. Push **OK** to enter curve zoom menu.
11. Push  to select X zoom.
12. Push **OK** to confirm.
13. Push  to mark the start position.
14. Push **OK** to confirm.
13. Push  to mark the end position.
14. Push **OK** to confirm. The area of the curve you select will be shown on the whole screen.
15. Push **BK** several times to return to run state.

Note: Shortcut key **BK** can display echo curve on measurement mode, but it has no zoom functions

Appendix

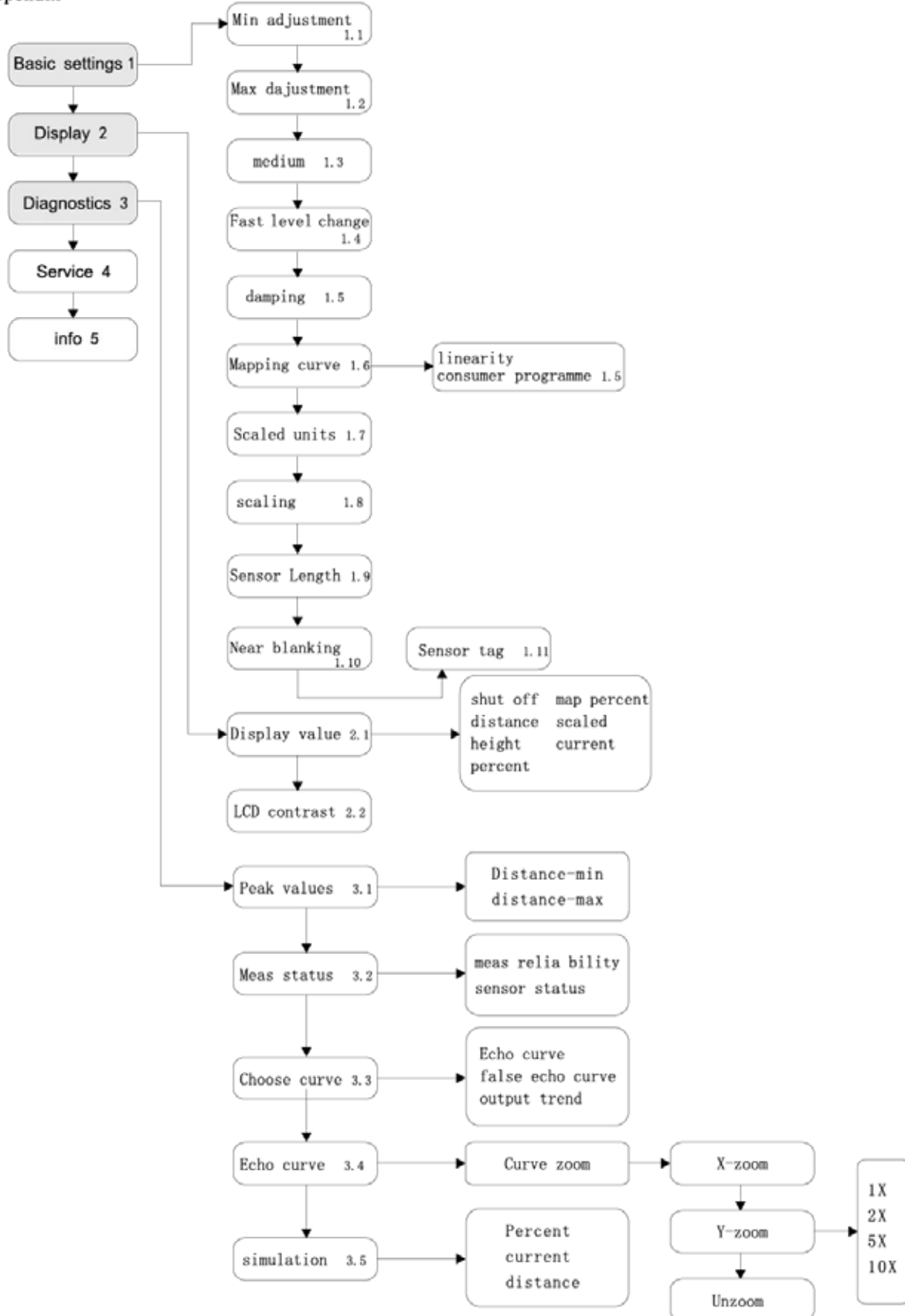

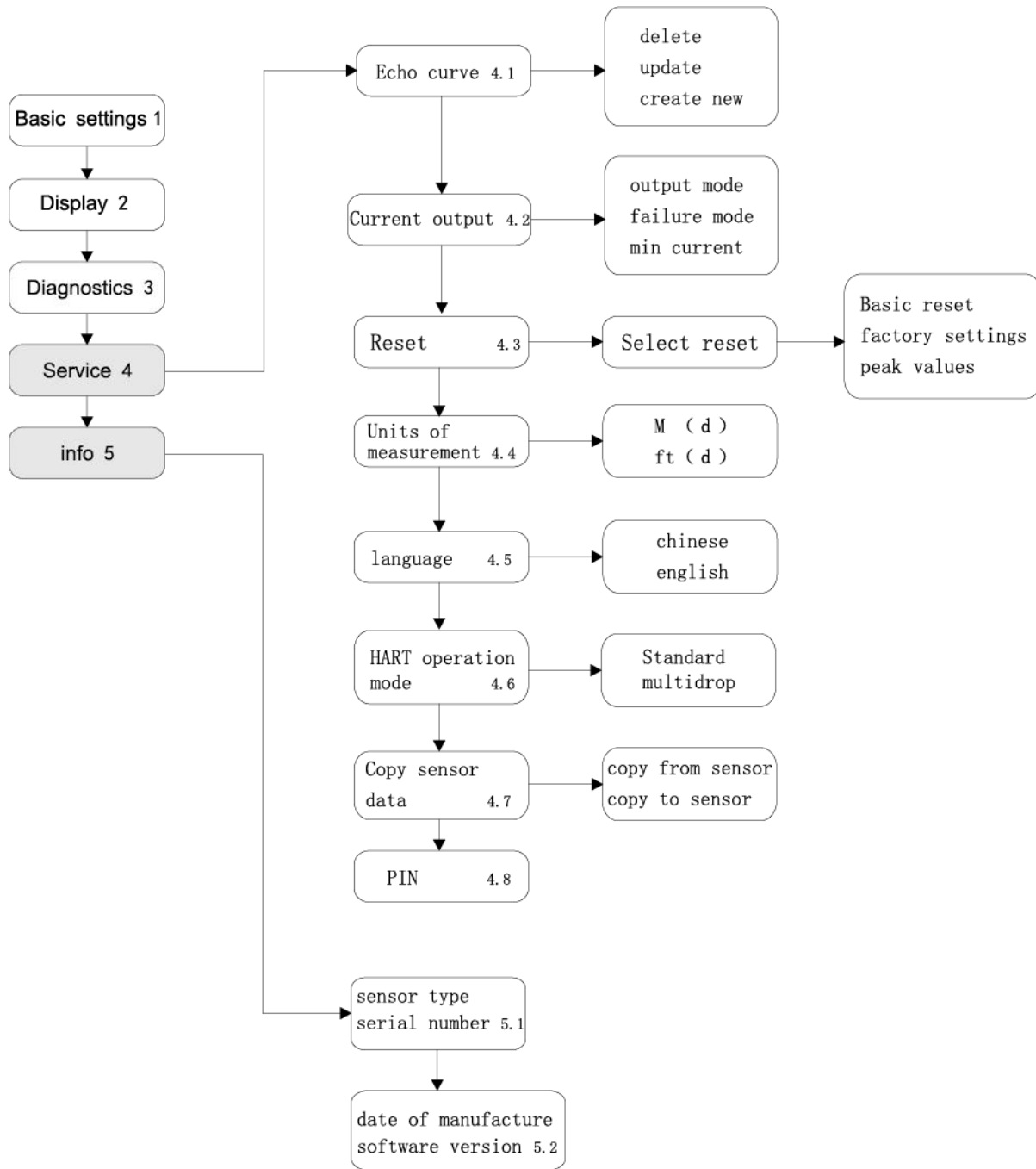



TEKMATION LLC reserves the right to change the designs and/or materials of its products without notice. The contents of this publication are the property of TEKMATON and cannot be reproduced by any other party without written permission. All rights reserved. Copyright © 2016 TEKMATON LLC
DOC:FEK/PO/MNL/200318/4100C/01
TEKMATION LLC



www.tek-trol.com

Tek-Trol is a fully owned subsidiary of TEKMATON LLC. We offer our customers a comprehensive range of products and solutions for process, power and oil & gas industries. Tek-Trol provides process measurement and control products for Flow, Level, Temperature & Pressure Measurement, Control Valves & Analyzer systems. We are present in 15 locations globally and are known for our knowledge, innovative solutions, reliable products and global presence.

Tek-Trol LLC

796 Tek Drive Crystal Lake, IL 60014 USA

Tel.: +1 847 857 6076 , +1 847 655 7428 Fax: +1 847 655 6147

Email: tektrol@tek-trol.com

www.tek-trol.com