



CONTENTS



Safety Precautions and Instructions	5
Basic Precautions.	5
Installation.	5
Power Connection	5
Protection Class	5
Setup and Operation	5
Remove Device from the Pipeline	6
RoHs.	6
System Description	6
Measuring Principle	6
Nameplate	7
Unpacking and Inspection	7
Rigging, Lifting and Moving Large Units	8
Meter Location, Orientation and Applications	9
Temperature Ranges	9
Meter Location	10
Remote Transmitter Outdoor Location	10
Inlet and Outlet Pipe	11
Meter Orientation	11
Straight Pipe Requirements	12
Pipe Reducer Requirements	12
Chemical Injection Applications	13
Partially Filled Pipe Situations.	13
Transmitter Mounting Configuration Options	14
Meter Mount Configuration	14
Remote Mount Configuration.	14
Submersible Option.	14
Protection Class	14
Meter Gaskets and Grounding	15
Meter/Pipeline Connection Gaskets	15
Meter Grounding	15
Conductive Pipe Grounding.	15
Pipelines with Cathodic Protection	16
Non-Conductive Pipe Grounding	16

Power Connections	17
Wiring Safety	17
Opening the M1000 Cover.	17
Auxiliary Power	18
Remote Version.	19
Signal Cable Specification	20
Maximum Cable Length at Different Fluid Temperatures.	20
Configuring Input/Output (I/O).	21
M1000 Main Menu Programming Options	23
Screen Layout.	23
Function Buttons.	23
Meter Setup Menu.	26
Measurement Menu.	27
Input/Outputs Menu	29
Totalizer Reset Menu	31
Communication Menu	32
Miscellaneous Menu	33
Information Menu	33
PIN Menu.	34
Login Screen	34
Maintenance	35
Cleaning the Flow Tube and Electrode	35
General Cleaning.	35
Troubleshooting	36
Errors and Warnings.	36
Repair of Faults	37
LED Status Indicators	37
Replacing Meter Electronics.	38
Connecting an AquaCUE/BEACON Encoder Interface to the M1000 Meter	39
Wiring.	39
Programming	39
Specifications.	40
Sensor Type II Specifications.	40
Sensor with Sanitary Process Connections Specifications	42
Sensor Type III Specifications	44
Transmitter Type ModMAG M1000 Specifications	45

Error Limits	46
Size Selection	47
Spare Parts	48

SAFETY PRECAUTIONS AND INSTRUCTIONS

Some procedures in this manual require special safety considerations. In such cases, the text is emphasized with the following symbols:

Symbol	Explanation
 DANGER	Indicates a hazardous situation, which, if not avoided, will result in death or serious personal injury.
 WARNING	Indicates a hazardous situation, which, if not avoided, could result in death or serious personal injury.
 CAUTION	Indicates a hazardous situation, which, if not avoided, could result in minor or moderate personal injury or damage to property.

CAUTION

IF THE EQUIPMENT IS USED IN A MANNER NOT SPECIFIED BY THE MANUFACTURER, THE PROTECTION PROVIDED BY THE EQUIPMENT MAY BE IMPAIRED.

ATTENTION

UTILISER L'ÉQUIPEMENT DE MANIÈRE NON SPÉCIFIÉE PAR LE FABRICANT POURRAIT DIMINUER LA PROTECTION ASSURÉE PAR L'ÉQUIPEMENT.

Basic Precautions

Before installing or using this product, please read this instruction manual thoroughly. Only qualified personnel should install and/or repair this product. If a fault appears, contact your distributor.

Installation

Do not place any unit on an unstable surface that may allow it to fall.

Never place the units above a radiator or heating unit.

Route all cabling away from potential hazards.

Isolate from the mains before removing any covers.

Power Connection

Use only the type of power source suitable for electronic equipment. If in doubt, contact your distributor. Make sure that any power cables are of a sufficiently high current rating. All units must be earthed to eliminate the risk of electric shock. Failure to properly earth a unit may cause damage to that unit or data stored within it.

Protection Class

The device has protection class IP 67 and needs to be protected against dripping water, oils and other liquids.

Setup and Operation

Adjust only those controls that are covered by the operating instructions. Improper adjustment of other controls may result in damage, incorrect operation or loss of data.

Remove Device from the Pipeline

If the device has been operated with toxic, caustic, flammable or water-endangering products, check and make sure, by rinsing or neutralizing if necessary, that all cavities are free from such dangerous substances before you remove the device.

RoHs

The M1000 meter is RoHs compliant.

SYSTEM DESCRIPTION

The Badger Meter Model M1000 electromagnetic flow meter is intended for fluid metering in most industries including water, wastewater, food and beverage, pharmaceutical and chemical.

The basic components of an electromagnetic flow meter are:

- The **sensor**, which includes the flow tube, isolating liner and measuring electrodes.
- The **transmitter**, which is the electronic device responsible for the signal processing, flow calculation, display and output signals.

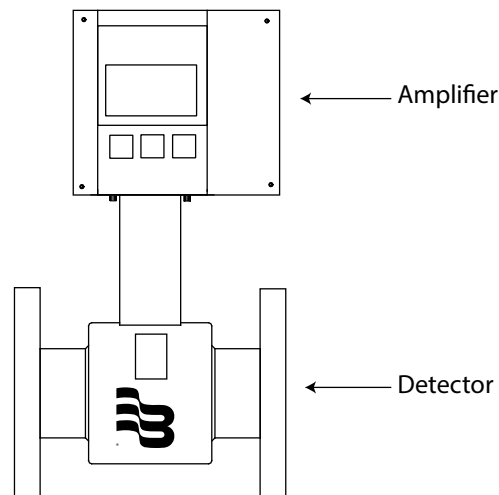

Figure 1: Transmitter and Sensor

The construction materials of the wetted parts (liner and electrodes) should be appropriate for the specifications on the intended type of service. We recommend that you review all of the compatibilities consistent with the specifications.

Each meter is factory tested and calibrated. A calibration certificate is included with each meter.

⚠ WARNING

CONSULT THE INSTALLATION INSTRUCTIONS BEFORE DETERMINING THE TEMPERATURE RATING OF THE CABLE.

⚠ AVERTISSEMENT

CONSULTEZ LES INSTRUCTIONS D'INSTALLATION AVANT DE DÉTERMINER LES CARACTÉRISTIQUES THERMIQUES DU CÂBLE.

IMPORTANT

Wire connections must meet or exceed a temperature rating of 176° F (80° C).

Measuring Principle

In accordance with Faraday's induction principle, electric voltage is induced in a conductor moving through a magnetic field. In electromagnetic flow measurement, the moving conductor is replaced by the flowing fluid. Two opposite measuring electrodes conduct the induced voltage, which is proportional to flow velocity to the transmitter. Flow volume is calculated based on pipe diameter.

Nameplate

Look at the device nameplate to be sure that the device is delivered according to your order. Check for the correct supply voltage printed on the nameplate.

Mod MAG MAG Sensor Head Serial No. Size Max. Temp. Nom. Pressure Electrodes Liner Sensor Factor Protection Rate	Mod MAG MAG Sensor Head Model Power Supply Protection Rate
--	--

Figure 2: Nameplate examples

UNPACKING AND INSPECTION

Follow these guidelines when unpacking the equipment.

- If a shipping container shows any sign of damage, have the shipper present when you unpack the meter.
- Follow all unpacking, lifting and moving instructions associated with the shipping container.
- Open the container and remove all packing materials. Store the shipping container and packing materials in the event the unit needs to be shipped for service.
- Verify that the shipment matches the packing list and your order form.
- Inspect the meter for any signs of shipping damage, scratches, or loose or broken parts.

NOTE: If the unit was damaged in transit, it is your responsibility to request an inspection report from the carrier within 48 hours. You must then file a claim with the carrier and contact Badger Meter for appropriate repairs or replacement.

- All sensors with polytetrafluoroethylene (PTFE) liners are shipped with a liner protector on each end to maintain proper form of the PTFE material during shipping and storage.

NOTE: Do not remove the liner protectors until you are ready to install.

- Storage: If the meter is to be stored, place it in its original container in a dry, sheltered location. Storage temperature ranges are: $-4...140^{\circ}\text{F}$ ($-20...60^{\circ}\text{C}$).

Rigging, Lifting and Moving Large Units

⚠ CAUTION

WHEN RIGGING, LIFTING OR MOVING LARGE UNITS, FOLLOW THESE GUIDELINES:

⚠ ATTENTION

POUR LE GRÈMENT, DU LEVAGE OU DU DÉPLACEMENT D'UNITÉS DE GRANDE TAILLE, VEUILLEZ SUIVRE CES INSTRUCTIONS :

- DO NOT lift or move a meter by its transmitter, junction box, sensor neck, or cables.
- Use a crane rigged with soft straps to lift and move meters with flow tubes that are 2...8 in. (50...200 mm). Place the straps around the sensor body, between the flanges, on each side of the sensor.
- Use lifting lugs when lifting meter flow tubes that are 5.91 inches (150 mm) in diameter or larger.
- Use the sling-rigged method to lift large sensors into a vertical position while they are still crated. Use this method to position large sensors vertically into pipelines.

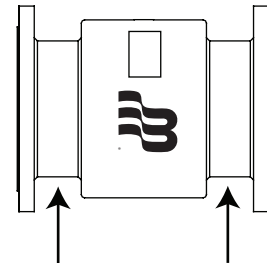

Place straps between flanges.

Figure 3: Rigging Large Units

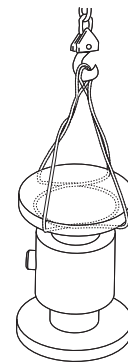
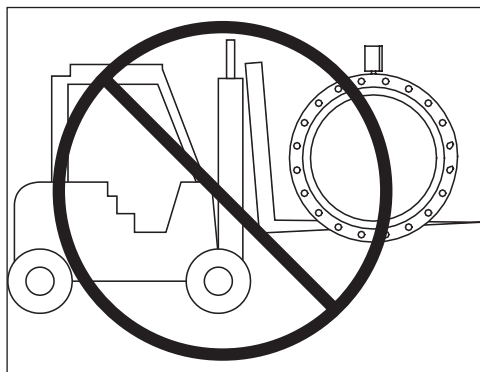
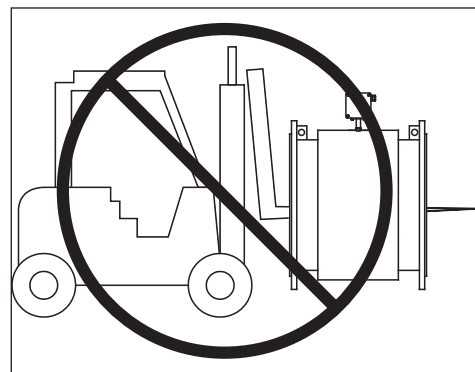

Figure 4: Sling-Rigged Lifting Methods

- Do not lift a sensor with a forklift by positioning the sensor body on the forks, with the flanges extending beyond the lift. This could dent the housing or damage the internal coil assemblies.
- Never place forklift forks, rigging chains, straps, slings, hooks or other lifting devices inside or through the sensor's flow tube to hoist the unit. This could damage the isolating liner.
- Do not lift meter with a fork lift on the jacket sheet. This could damage the body.



Do not lift sensor with forklift



Do not lift or rig lifting devices through sensor

Figure 5: Lifting and rigging cautions

METER LOCATION, ORIENTATION AND APPLICATIONS

The M1000 provides two transmitter mounting options: an integral or meter mount option and a junction box/remote option.

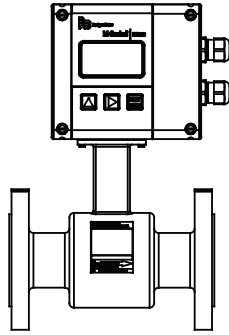

Figure 6: Meter mount transmitter

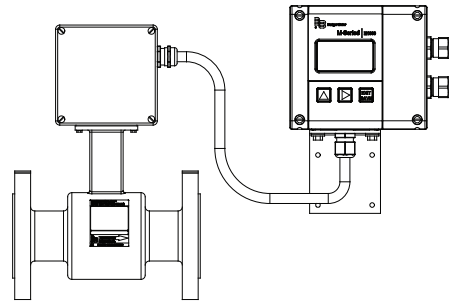

Figure 7: Junction box with remote transmitter

Temperature Ranges

⚠ CAUTION

TO PREVENT DAMAGE TO THE METER, STRICTLY OBSERVE THE MAXIMUM TEMPERATURE RANGES OF THE TRANSMITTER AND SENSOR.

⚠ ATTENTION

AFIN D'ÉVITER TOUT DOMMAGE AU COMPTEUR, RESPECTEZ RIGOREUSEMENT LES PLAGES DE TEMPÉRATURES MAXIMALES DE L'AMPLIFICATEUR ET DU DÉTECTEUR.

- In regions with extremely high ambient temperatures, it is recommended to protect the transmitter from direct sunlight.
- In cases where fluid temperature exceeds 212° F (100° C), use the remote version.

Transmitter	Ambient temperature		–4...140° F (–20...60° C)
Sensor	Fluid temperature	PTFE / PFA	–40...302° F (–40...150° C)
		Hard rubber	32...176° F (0...80° C)
		Soft Rubber	32...176° F (0...80° C)

Meter Location

CAUTION

- Do not install the sensor on the suction side of pumps. This could damage the liner (in particular PTFE liners).
- Verify that the pipeline is always filled on the measuring point. If not a correct or accurate measurement is not possible.
- Do not install the sensor on the highest point of a pipeline system. Gas accumulation may follow.
- Do not install the sensor in downcomer pipes with free outlet.
- Do not install the meter on pipes with extreme pipe vibrations. If pipes are vibrating, secure the piping with appropriate pipe supports in front of and behind the meter. If vibrations cannot be restrained, mount the transmitter in a remote location.
- Do not install the sensor close to pipeline valves, fittings or impediments that can cause flow disturbances.
- Do not install the sensor on outlet sides of piston or diaphragm pumps. Pulsating flow can affect meter performance.
- Avoid installing the sensor near equipment that produces electrical interference such as electric motors, transformers, variable frequency and power cables.
- Verify that both ends of the signal cables are securely fastened.
- Place power cables and signal cables in separate conduits.
- Place the meter where there is enough access for installation and maintenance tasks.

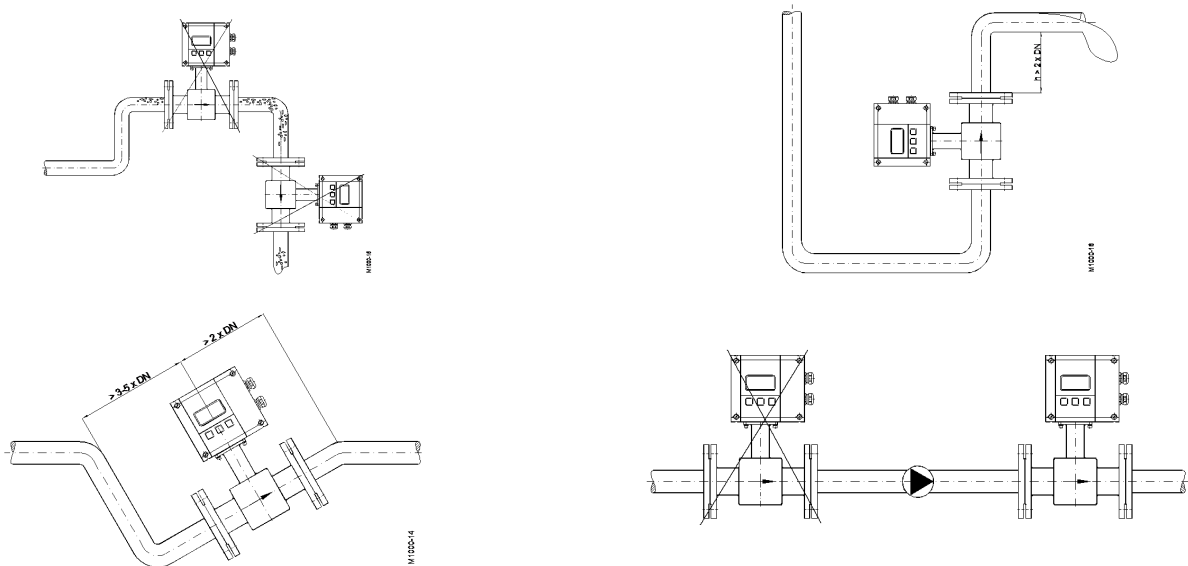

Figure 8: Meter location

Remote Transmitter Outdoor Location

The transmitter can be installed and operated outdoors. However, it must be protected from the elements as follows:

- The ambient environment/temperature rating for the unit is $-4 \dots 140^\circ \text{F}$ ($-20 \dots 60^\circ \text{C}$).
- If an indoor location is within 150 feet (50 meters) of the sensor, consider increasing the cable length and mounting the transmitter indoors.
- At minimum, create a roof or shield over and/or around the transmitter to protect the LCD display screen from direct sunlight.
- See “Remote Mount Configuration” on page 14.

Inlet and Outlet Pipe

Always install the sensors in front of fittings producing turbulences. If this is not possible, plan for distances greater than $3 \times \text{DN}$. Distance should be greater than $2 \times \text{DN}$.

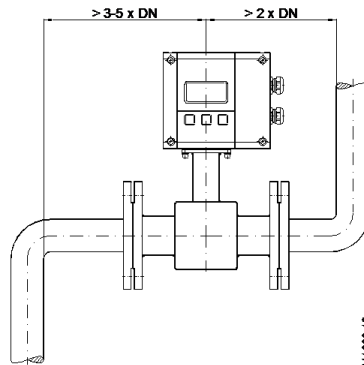

Figure 9: Inlet and outlet pipe

Meter Orientation

Mag meters can operate accurately in any pipeline orientation and can measure volumetric flow in forward and reverse directions.

NOTE: A "Forward Flow" direction arrow is printed on the sensor label.

Vertical Placement

Mag meters perform best when placed vertically, with liquid flowing upward and meter electrodes in a closed, full pipe.

Vertical placement allows the pipe to remain completely full, even in low flow, low pressure applications, and it prevents solids build-up, sediment deposit and accumulation on the liner and electrodes.

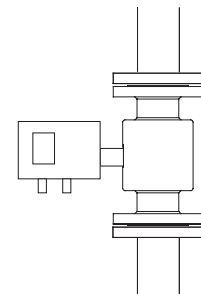

Figure 10: Vertical placement

Horizontal Placement

M1000 meters are equipped with an *Empty Pipe Detection* feature. If an electrode mounted in the pipe is not covered by fluid for five seconds, the meter will display an *Empty Pipe Detection* condition. The meter will send out an error message and stop measuring flow. When the electrode is again covered with fluid, the error message disappears and the meter will begin measuring.

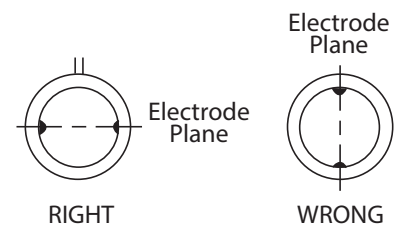

Figure 11: Horizontal placement

When installing the meter on a horizontal pipe, mount the sensor to the pipe with the flow-measuring electrode axis in a horizontal plane (three and nine o'clock). This placement helps prevent solids build-up, sediment deposit and accumulation on the electrodes.

Straight Pipe Requirements

Sufficient straight-pipe runs are required at the sensor inlet and outlet for optimum meter accuracy and performance. An equivalent of three diameters of straight pipe is required on the inlet (upstream) side. Two diameters are required on the outlet (downstream) side.

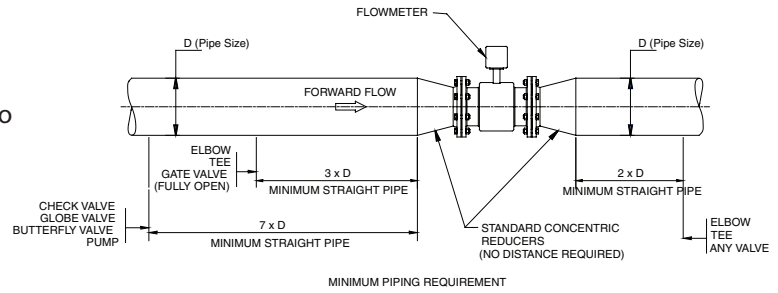

Figure 12: Straight pipe requirements

Pipe Reducer Requirements

With pipe reducers, a smaller meter can be mounted in larger pipelines. This arrangement may increase low-flow accuracy.

There are no special requirements for standard, concentric pipe reducers.

Custom fabricated pipe reducers must have an approximate slope angle of 8 degrees to minimize flow disturbances and excessive loss of head. If this is not possible, install the custom pipe reducers as if they were fittings and install the required amount of straight pipe.

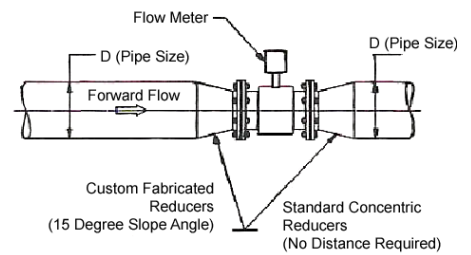

Figure 13: Pipe reducer requirements

You can determine the occurring pressure drop by using the shown nomogram (only applicable to liquids with similar viscosity like water).

NOTE: In cases where flow velocities are very low, you can increment them by reducing the size on the measuring point and hence obtain a better measuring accuracy.

Define pressure loss:

1. Calculate diameter ratio d/D .
2. Read pressure loss depending on d/D ratio and flow velocity.

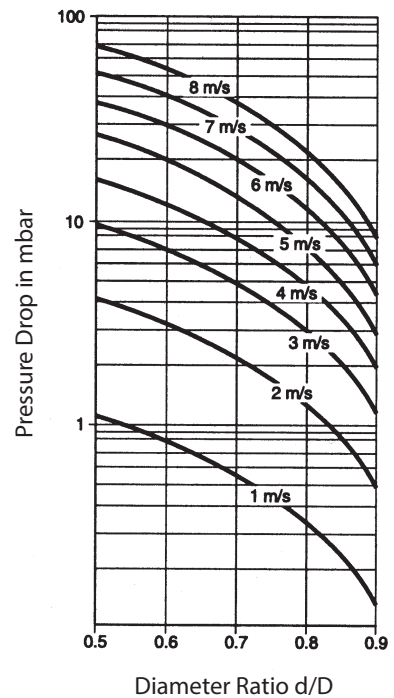

Figure 14: Pressure drop nomogram

Chemical Injection Applications

For water line applications with a chemical injection point, install the meter upstream of the injection point. This eliminates any meter performance issues.

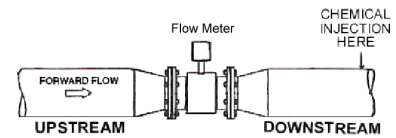

Figure 15: Chemical injection point downstream of meter

If a meter must be installed downstream of a chemical injection connection, the distance between the flange and the injection point should be between 50...100 feet (15...30 meters). The distance must be long enough to allow the water or chemical solution to reach the meter in a complete, homogeneous mixture.

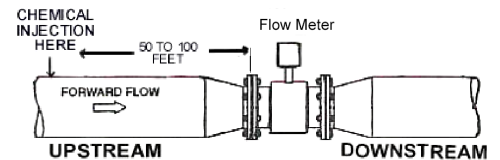

Figure 16: Chemical injection point upstream of meter

If the injection point is too close, the meter senses the two different conductivities for each liquid. This will likely result in inaccurate measurements. The injection method—spaced bursts, continuous stream of drips or liquid or gas—can also affect downstream readings by the meter.

Partially Filled Pipe Situations

In some locations, the process pipe may be momentarily only partially filled. Examples include: lack of back pressure, insufficient line pressure and gravity flow applications.

To eliminate these situations:

- Do not install the meter at the highest point of the pipeline.
- Do not install the meter in a vertical, downward flow section of pipe.
- Always position the ON/OFF valves on the downstream side of the meter.

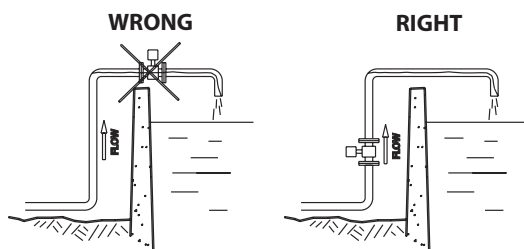
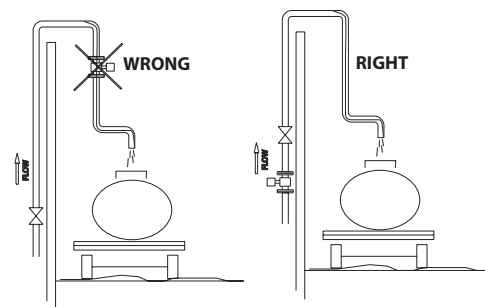

Figure 17: Meter placement



Do not install in a vertical, downward position. Position "On/Off" valves on downstream side.

Figure 18: Position valves on downstream side

To minimize the possibility of partially full pipe flows in horizontal, gravity or low pressure applications, create a pipe arrangement that allows the sensor to remain full of liquid at all times.

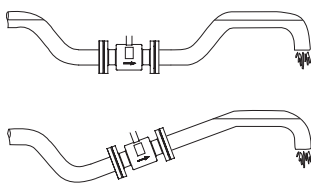

Figure 19: Pipe positioned to keep water in sensor

TRANSMITTER MOUNTING CONFIGURATION OPTIONS

There are two configurations for mounting the transmitter and many options to accommodate a variety of meter placement and environmental conditions.

Meter Mount Configuration

The meter mount configuration has the transmitter mounted directly on the sensor. This compact, self-contained configuration minimizes installation wiring.

Remote Mount Configuration

The remote mount configuration places the transmitter at a location away from the fluid flow and sensor. This is necessary in situations where process fluid temperature or the environment exceeds transmitter ratings.

The sensor and transmitter are connected by wires, run through conduit, between junction boxes on the sensor and the transmitter. The distance between the sensor junction box and transmitter junction box can be up to 150 feet (50 meters). A remote mounting bracket is supplied.

Use a remote mount configuration in the following cases:

- Sensor protection class IP 68
- Medium temperature > 212° F (100° C)
- Strong vibrations

⚠ CAUTION

DO NOT INSTALL THE SIGNAL CABLE CLOSE TO POWER CABLES, ELECTRIC MACHINES, ETC.

MAKE SURE THAT SIGNAL CABLES ARE SECURELY FASTENED. DUE TO CAPACITY CHANGES, CABLE MOVEMENTS MAY RESULT IN INCORRECT MEASUREMENTS.

FOR MEDIUM TEMPERATURE HIGHER THAN 158° F (70° C) MAKE SURE THAT ANY CABLE IS NOT IN CONTACT WITH THE HOT SURFACE OF THE SENSOR.

Submersible Option

If you are installing the meter in a vault, you should order the remote mount, submersible transmitter option. You must not install the transmitter inside a vault. This will eliminate any potential problems resulting from humidity or temporary flooding in the vault.

NOTE: National Electronics Manufacturer's Association (NEMA) 6P enclosures are constructed for indoor or outdoor use to provide protection against access to hazardous parts; to provide a degree of protection against ingress of solid foreign objects and water (hose directed water and the entry of water during prolonged submersion at a limited depth); to provide an additional level of protection against corrosion and will be undamaged by the external formation of ice on the enclosure.

Protection Class

To fulfill requirements of the protection class, follow these guidelines:

⚠ CAUTION

- **BODY SEALS NEED TO BE UNDAMAGED AND IN PROPER CONDITION.**
- **ALL OF THE BODY SCREWS NEED TO BE FIRMLY TIGHTENED.**
- **OUTER DIAMETERS OF THE USED WIRING CABLES MUST CORRESPOND TO CABLE INLETS (FOR M20 DIAMETER 5...13 MM). IN CASES WHERE CABLE INLET IS NOT USED, PUT ON A DUMMY PLUG.**
- **TIGHTEN CABLE INLETS.**
- **IF POSSIBLE, LEAD CABLE AWAY DOWNWARDS. HUMIDITY MUST NOT GET INTO CABLE INLET.**

- **WE NORMALLY DELIVER THE METER IN ACCORDANCE WITH PROTECTION CLASS IP 67. IF YOU HOWEVER REQUIRE A HIGHER PROTECTION CLASS, THE AMPLIFIER IS TO BE INSTALLED SEPARATELY FROM THE DETECTOR. IF REQUESTED, WE CAN ALSO DELIVER THE DETECTOR IN IP 68.**

⚠ ATTENTION

- **LES JOINTS DE CORPS NE DOIVENT PAS ÊTRE ENDOMMAGÉS ET ÊTRE EN BON ÉTAT.**
- **TOUTES LES VIS DE CORPS DOIVENT ÊTRE FERMEMENT SERRÉES.**
- **LE DIAMÈTRE EXTÉRIEUR DES FILS DE CÂBLAGE UTILISÉS DOIVENT CORRESPONDRE AUX ENTRÉES DE CÂBLE (POUR M20 DIAMÈTRE 5...13 MM). DANS LES CAS OÙ L'ENTRÉE DE CÂBLE N'EST PAS UTILISÉE, METTEZ UNE FICHE ISOLANTE.**
- **SERREZ LES ENTRÉES DE CÂBLE.**
- **SI CELA EST POSSIBLE, DIRIGEZ LE CÂBLE VERS LE BAS. ÉVITEZ QUE DE L'HUMIDITÉ NE PÉNÈTRE DANS L'ENTRÉE DE CÂBLE.**
- **LE COMPTEUR OFFERT EST NORMALEMENT CONFORME À LA CLASSE DE PROTECTION IP 67. CEPENDANT, SI VOUS EXIGEZ UNE CLASSE DE PROTECTION SUPÉRIEURE, L'AMPLIFICATEUR DOIT ÊTRE INSTALLÉ SÉPAREMENT DU DÉTECTEUR. SUR DEMANDE, LE DÉTECTEUR PEUT ÊTRE OFFERT EN IP 68.**

METER GASKETS AND GROUNDING

Gasket and grounding requirements must be considered when determining the meter location, orientation and application.

Meter/Pipeline Connection Gaskets

You must install gaskets (not provided) between the sensor's isolating liner and the pipeline flange to ensure a proper and secure hydraulic seal. Use gaskets that are compatible with the fluid. Center each gasket on the flange to avoid flow restrictions or turbulence in the line.

During installation, do not use graphite or any electrically conductive sealing compound to hold the gaskets. This could compromise the accuracy of the measuring signal.

If you are using a grounding ring in the sensor/pipeline connection, place the ring between two gaskets. (See "Pipelines with Cathodic Protection" on page 16.)

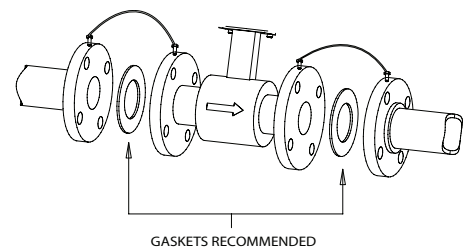

Figure 20: Meter/pipeline connection gaskets

Meter Grounding

Process pipeline material can be either electrically conductive (metal) or not electrically conductive (made of or lined with PVC, fiberglass or concrete).

IMPORTANT

It is essential that the meter transmitter's input ground (zero voltage reference) be electrically connected to the liquid media and to a good, solid earth ground reference.

Conductive Pipe Grounding

To achieve an adequate ground, the meter body **MUST** be electrically connected to the liquid media. The meter flanges are provided with grounding bolts for this purpose.

If the pipe material is electrically conductive, simply install grounding straps between these grounding bolts and the mating flanges.

To provide a good electrical connection at the mating flanges, we recommend that you drill and tap the flanges and install a grounding screw (not provided).

Grounding straps must be copper wire, at least 12 AWG size. They must be connected on both sides (inlet and outlet) of the sensor and to a local, earth ground.

Pipelines with Cathodic Protection

For pipelines with cathodic protection, install the meter with potential-free contacts. No electric connection from the meter to the pipeline system may exist and power supply is to be provided via isolating transformer.

CAUTION

USE GROUNDING ELECTRODES (GROUNDING RINGS ALSO NEED TO BE INSTALLED ISOLATED FROM THE PIPELINE SYSTEM).

ATTENTION

UTILISEZ LES ÉLECTRODES DE MISE À LA TERRE (LES ANNEAUX DE MISE À LA TERRE DOIVENT ÊTRE INSTALLÉES À PARTIR DU SYSTÈME DE CONDUITES).

Observe national rules for potential-free installations.

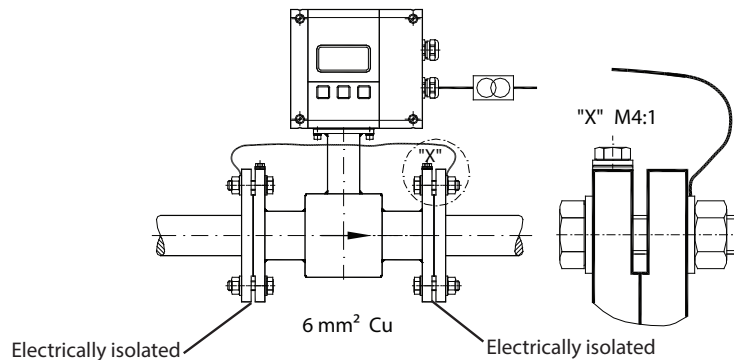

Figure 21: Cathodic protection

Non-Conductive Pipe Grounding

If the process pipe is not electrically conductive (PVC, fiberglass, cement-lined pipes or any other non-conductive material) and the meter was not originally ordered with an optional grounding electrode, you must install a pair of grounding rings between the mating flanges at both ends of the meter. See the following illustration.

In this case, the grounding straps should be connected to both of the grounding rings and to a good, solid earth ground. Grounding rings are available in stainless steel. If your fluid is too aggressive for stainless steel, order a meter with the optional grounding electrode in a material compatible with the fluid.

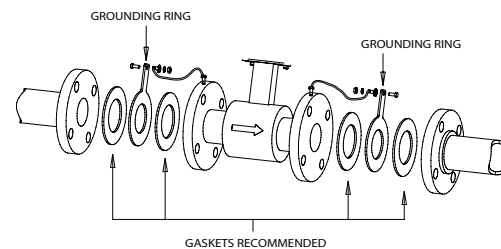

Figure 22: Non-conductive pipe grounding

POWER CONNECTIONS

Wiring Safety

⚠ WARNING

AT INSTALLATION, BE SURE TO COMPLY WITH THE FOLLOWING REQUIREMENTS:

- Disconnect power to the unit before attempting any connection or service to the unit.
- Do not bundle or route signal lines with power lines.
- Keep all lines as short as possible.
- Use twisted pair shielded wire for all output wiring.
- Observe all applicable local electrical codes.

⚠ AVERTISSEMENT

LORS DE L'INSTALLATION, ASSUREZ-VOUS DE RESPECTER LES EXIGENCES SUIVANTES :

- Débranchez l'appareil avant d'essayer toute connexion ou tout service à l'appareil.
- Ne par regrouper ou acheminer les lignes de signaux aux lignes électriques.
- Gardez toutes les lignes aussi courtes que possible.
- Utilisez un câble blindé à paire torsadée pour tout le câblage de sortie.
- Respectez tous les codes locaux applicables en matière d'électricité.

Opening the M1000 Cover

The M1000 transmitter design lets you open the cover without completely removing it.

Follow these steps:

1. Completely remove the top two screws from the transmitter using a blade/slotted screwdriver.
 2. Loosen both of the bottom screws so that the round head of each screw clears the top face of the cover.
 3. Pull down the cover to the open position.
- For the 2 × M20 cable inlets, use only flexible electric cables.
 - Use separate cable inlets for auxiliary power, signal and input/output cables.



Figure 23: Remove two screws

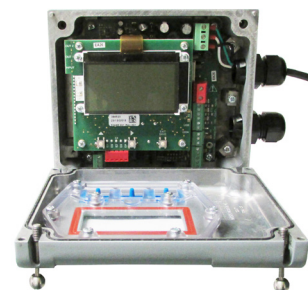

Figure 24: Open the cover

Auxiliary Power

⚠ CAUTION

TO PREVENT ACCIDENTS, CONNECT MAIN POWER ONLY AFTER ALL OTHER WIRING HAS BEEN COMPLETED.

⚠ ATTENTION

AFIN D'ÉVITER LES ACCIDENTS, BRANCHEZ L'ALIMENTATION PRINCIPALE SEULEMENT UNE FOIS TOUT LE CÂBLAGE COMPLÉTÉ.

⚠ WARNING

- Do not connect meter under impressed mains voltage.
 - Observe type plate (mains voltage and frequency).
 - Equipment is provided with an external means for disconnecting the meter from each operating energy supply source. The disconnecting means can disconnect all current-carrying conductors.
1. Open the cover (see "Opening the M1000 Cover" on page 17).
 2. Push the auxiliary power cable through the upper cable inlet.
 3. Connect as shown in *Figure 25*.
 4. Close the cover and tighten the screws.

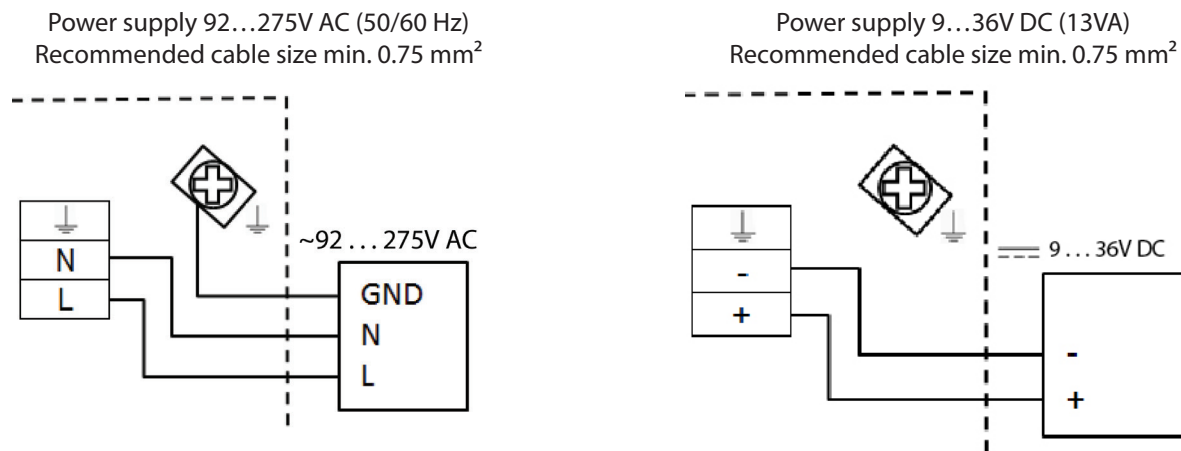

Figure 25: Auxiliary power connection

Remote Version

CAUTION

CONNECT OR REMOVE THE SIGNAL CONNECTION CABLE ONLY WHEN THE UNIT HAS BEEN SWITCHED OFF.

ATTENTION

BRANCHEZ OU RETIREZ LE CÂBLE DU SIGNAL DE CONNEXION UNIQUEMENT LORSQUE L'APPAREIL EST ÉTEINT.

Connection to the Measuring Transmitter

1. Open the cover (see "Opening the M1000 Cover" on page 17).
2. Push the signal cable through the lower cable inlet.
3. Connect as shown in Figure 26.
4. Close the cover and tighten the screws and the wire gland.

Connection to the Junction Box

1. Open the junction box.
2. Push the signal cable through the upper cable inlet.
3. Connect as shown in Figure 26.
4. Close the cover and tighten the screws and wire gland.

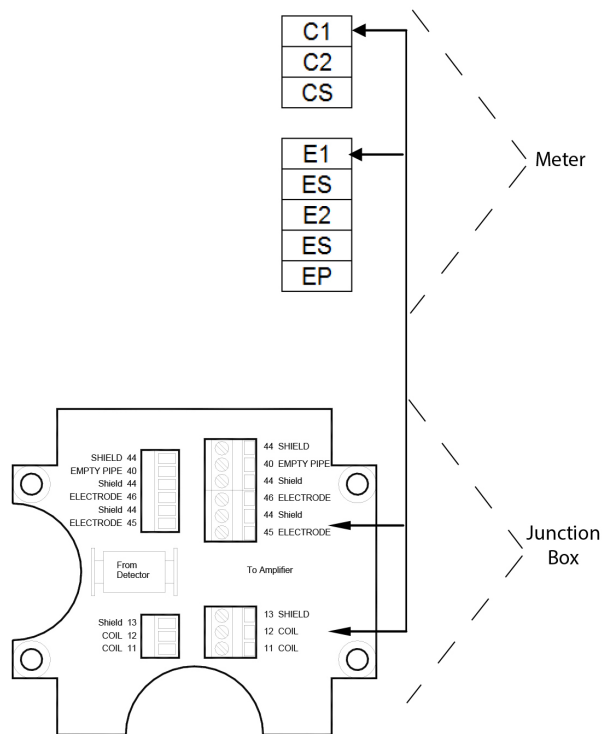

Figure 26: Remote version connection

Junction Box	M1000	Description	Wire Color
11	C1	Coil 1	Green
12	C2	Coil 2	Yellow
13	CS	Main shield	Yellow/Green
45	E1	Electrode 1	White
44*	ES	Electrode shield	Black
46	E2	Electrode 2	Brown
40	EP	Empty pipe	Pink
44*	ES	Empty pipe shield	Black

* Connections with number 44 are on the same potential.

Signal Cable Specification

NOTE: Only use signal cables delivered by Badger Meter or corresponding cable in accordance with the following specification. Take maximum signal cable length between sensor and transmitter into account (keep distance as low as possible).

Distance	With electrode idle	Loop resistance
0...164 ft (0...50 m)	$3 \times (2 \times 0.25 \text{ mm}^2)$	$\leq 160 \Omega/\text{km}$
PVC cable with pair and total shield		
Capacity: wire/wire < 120 nF/km, wire/shield < 160 nF/km		
Temperature range -22...158° F (-30...70° C)		

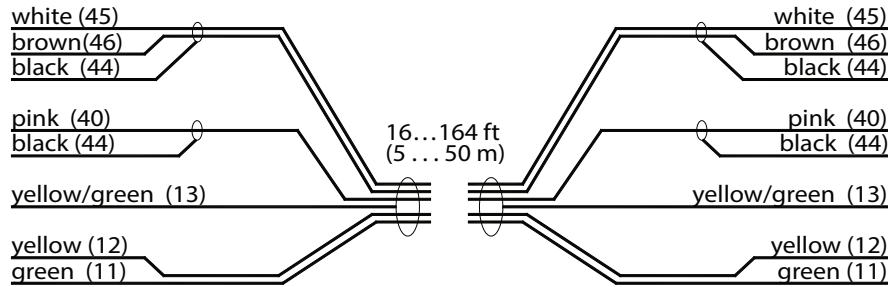
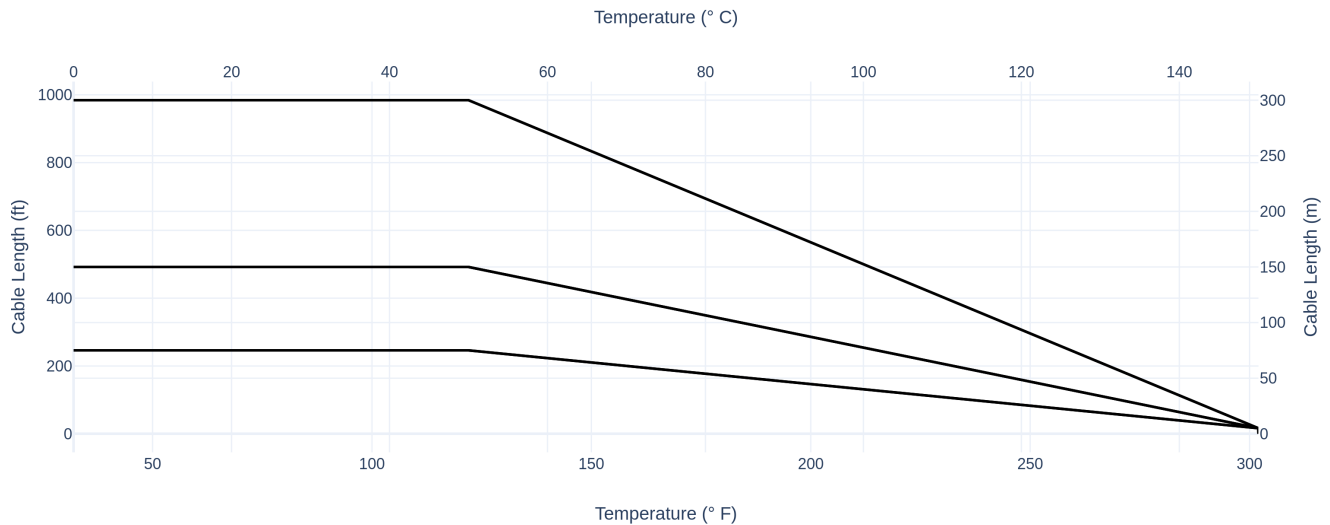

Figure 27: Signal cable specification

Maximum Cable Length at Different Fluid Temperatures



Configuring Input/Output (I/O)

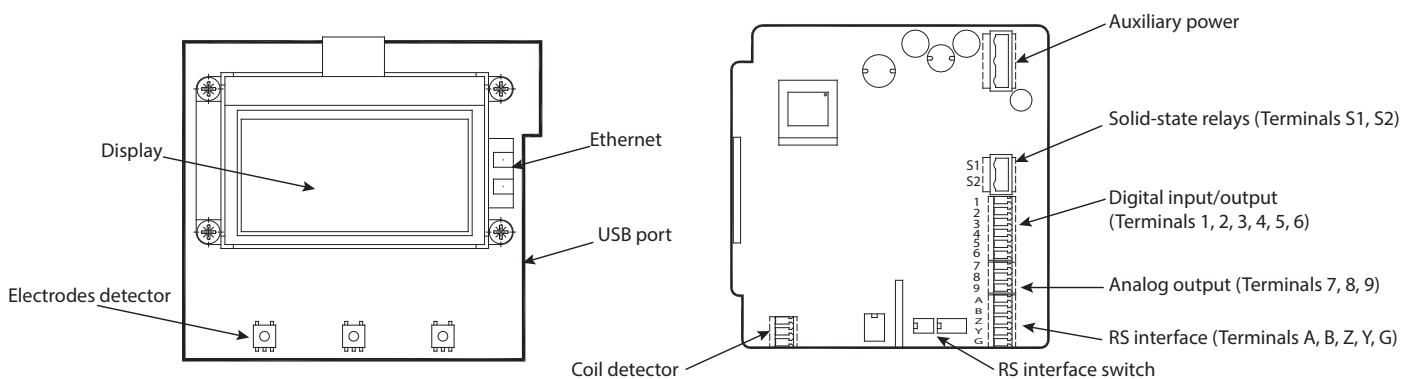

Figure 28: Configuring I/O

Input/Output	Description	Terminal																											
Analog Output	0...20 mA 4...20 mA 0...10 mA	7 (+) 8 (-) 9 (GND)																											
Digital Output																													
1	Open collector max. 10 kHz • Passive max. 32V DC, <100 Hz 100 mA, >100 Hz 20 mA • Active 24V DC, 20 mA (can be powered by analog output if not used)	3 (-) 4 (+)																											
2	Open collector max. 10 kHz • Passive max. 32V DC, <100 Hz 100 mA, >100 Hz 20 mA • Active 24V DC, 20 mA (can be powered by analog output if not used)	1 (-) 2 (+)																											
	Solid-state relays max. 230V AC, 500 mA, max 1 Hz (Function is linked with Output 2)	S1 and S2																											
Digital Input	5...30V DC	5 (-) and 6 (+)																											
RS-Interfaces	RS-232, RS-485 and RS-422 with Modbus® RTU. Mode can be configured by DIP switches when termination is ON or OFF.	<table border="1"> <thead> <tr> <th rowspan="2">Connector Label</th> <th colspan="3">RS Interfaces</th> </tr> <tr> <th>422</th> <th>232</th> <th>485</th> </tr> </thead> <tbody> <tr> <td>A</td> <td>A</td> <td>RxD</td> <td>—</td> </tr> <tr> <td>B</td> <td>B</td> <td>—</td> <td>—</td> </tr> <tr> <td>Z</td> <td>Z</td> <td>TxD</td> <td>B</td> </tr> <tr> <td>Y</td> <td>Y</td> <td>—</td> <td>A</td> </tr> <tr> <td>G</td> <td colspan="3">G (GND)</td> </tr> </tbody> </table>	Connector Label	RS Interfaces			422	232	485	A	A	RxD	—	B	B	—	—	Z	Z	TxD	B	Y	Y	—	A	G	G (GND)		
Connector Label	RS Interfaces																												
	422	232	485																										
A	A	RxD	—																										
B	B	—	—																										
Z	Z	TxD	B																										
Y	Y	—	A																										
G	G (GND)																												
USB	USB Device CDC (Host Mass Storage)	Micro USB																											
Ethernet	Ethernet interface connection	RJ45 socket																											

Input and Output Cable Connection

For normal I/Os, use shielded cables. Connect the shield of the cable to one of the grounding screws. Recommended cable LiYCY size min. 0.14 mm².

Solid State Output

In case the second cable gland is used for the normal I/Os, use one cable and cable gland for the power supply and solid state relay. Recommended cable size min. 0.75 mm².

⚠ CAUTION

USE SEPARATE CABLE INLETS FOR CABLES CONNECTED TO THE SOLID STATE RELAY OUTPUT AND CABLES CONNECTED TO THE OTHER INPUT/OUTPUTS.

IN MULTIPHASE NETS, SOLID STATE RELAY SHOULD HANDLE ONLY THE SAME PHASE THAT IS USED FOR POWERING THE METER.

⚠ ATTENTION

UTILISEZ DES ENTRÉES DE CÂBLE DISTINCTES POUR LES CÂBLES BRANCHÉS À LA SORTIE DES RELAIS STATIQUES ET AUX CÂBLES BRANCHÉS AUX AUTRES ENTRÉES OU SORTIES.

POUR LES FILETS MULTIPHASES, LE RELAIS STATIQUE NE DEVRAIT SERVIR QUE LA MÊME PHASE UTILISÉE POUR ALIMENTER LE COMPTEUR.

M1000 MAIN MENU PROGRAMMING OPTIONS

Screen Layout

The following M1000 programming options are available from the *Main Menu*:

- *Meter Setup*
- *Measurement*
- *Input/Outputs*
- *Totals*
- *Communications*
- *Miscellaneous*
- *Information*
- *Pin*
- *Login*

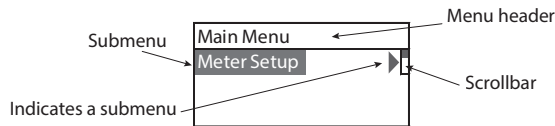

Figure 29: Screen layout

Function Buttons

Use the three function buttons on the front of the transmitter to program the M1000. Perform screen navigation, digit and parameter selection by pressing a combination of these three buttons.











Press ▲ to scroll through the menu screens, cycle through options in a list or cycle through digits when entering a number.

Press ► or **EXIT SAVE** to enter a menu or move to the next submenu. The scrollbar on the upper right shows your position in the list. Press **EXIT SAVE** to return from a submenu to the upper menu.

To select parameters or values from a list in a menu point, first press ▲ until the parameter or value is displayed then press **EXIT SAVE** to select it. The current number in the list is marked by a little black square to the left of the number. For example, ■DN 50.

To change a parameter, press ► to enter the menu. The first character flashes. Press ▲ to change the value. Once you have changed the value, press ► to move to the next value. Press **EXIT SAVE** to confirm the new value.







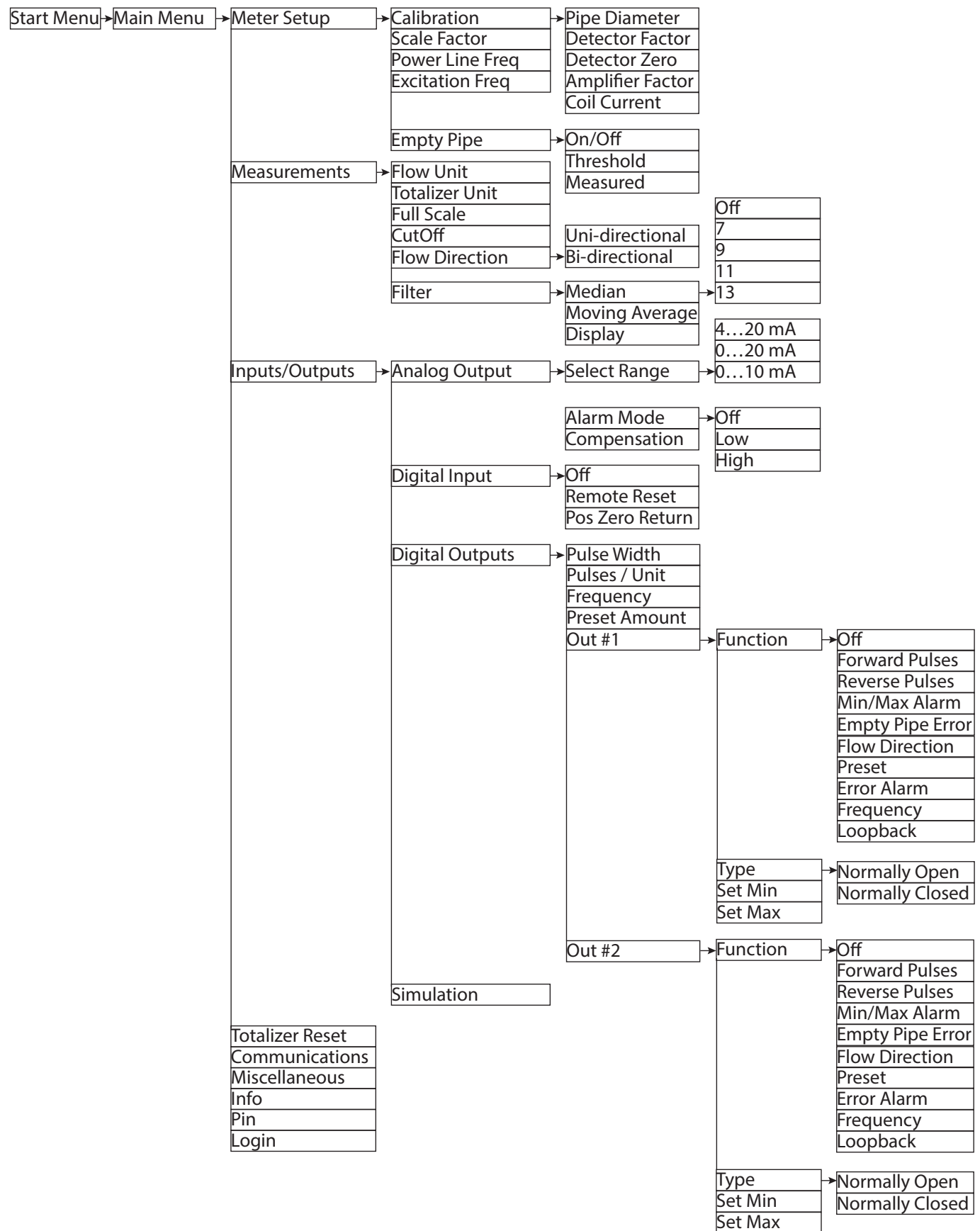

Status Icons

-  Communication interface is activated
-  Meter is unlocked
-  Error message
-  Empty pipe detection
-  Low battery
-  Exceeded full scale
-  Memory problem
-  Simulation active
-  USB active





Menu Structure







Meter Setup Menu



Meter Setup										
Calibration	Diameter 	This parameter is set at the factory. In the event the transmitter is replaced, verify that the pipe diameter matches the installed pipe size.								
	Sensor Factor 	This parameter is set at the factory. This factor compensates for accuracy error as a result of the installed sensor. In the event the transmitter is replaced, this parameter must be reprogrammed with the original sensor zero.								
	Sensor Zero 	This parameter is set at the factory. This parameter compensates for accuracy error as a result of the installed sensor. If accuracy adjustment of the meter is required, refer to the scale factor.								
	Transmitter Factor	This parameter is set at the factory and is Read Only. This electronic calibration factor compensates for accuracy error as a result of the installed transmitter.								
	Coil Current	This parameter (coil current to the sensor) is set at the factory and is Read Only. This factor compensates for accuracy error as a result of the installed transmitter.								
Scale Factor 	Changing the scale factor lets you adjust the meter accuracy without disturbing parameters set by the factory. You can tune the meter to meet changing application requirements in a range of $\pm 5\%$ (0.95...1.05).									
Power Line Frequency 	For optimum operation of the meter, set Power Line Frequency to 50 Hz or 60 Hz in this menu at operating location.									
Excitation Frequency 	<p>This parameter is set at the factory. This value shows in which frequency the meter coils are operated. Supported frequencies are dependent on the configured power line frequency and meter size.</p> <table border="1" data-bbox="386 1102 701 1207"> <thead> <tr> <th>50 Hz</th> <th>60 Hz</th> </tr> </thead> <tbody> <tr> <td>3.125 Hz</td> <td>3.75 Hz</td> </tr> <tr> <td>6.25 Hz</td> <td>7.5 Hz</td> </tr> <tr> <td>12.5 Hz</td> <td>15 Hz</td> </tr> </tbody> </table> <p>NOTE: When selecting excitation frequency, make sure to always observe that the ratio in respect of power frequency is integer.</p>		50 Hz	60 Hz	3.125 Hz	3.75 Hz	6.25 Hz	7.5 Hz	12.5 Hz	15 Hz
50 Hz	60 Hz									
3.125 Hz	3.75 Hz									
6.25 Hz	7.5 Hz									
12.5 Hz	15 Hz									
Empty Pipe Detection 	ON/OFF 	When set to ON, an Empty Pipe condition indicates to the outputs that the meter is not completely filled. When set to OFF, empty pipe conditions are not detected.								
	Threshold 	Threshold value for empty pipe detection. For liquids with lower conductivity or long cables, the threshold value must be increased. The actual value can be monitored in the next menu "Measured".								
	Measured	Measures the real empty pipe value. This parameter is Read Only.								





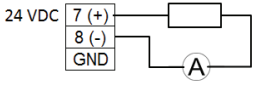
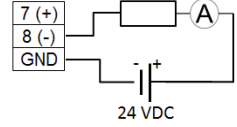

Measurement Menu

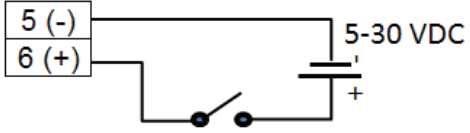
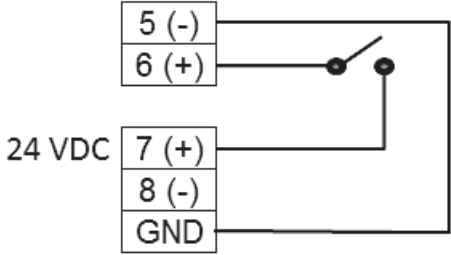

Measurement																																									
Flow Unit 	<p>Flow Units let you select among the flow units listed below. Flow units are automatically converted into the selected unit.</p> <table border="1"> <thead> <tr> <th><i>Display</i></th> <th><i>Flow Unit</i></th> <th><i>Display</i></th> <th><i>Flow Unit</i></th> </tr> </thead> <tbody> <tr> <td>L/s</td> <td>Liters/Second</td> <td>gal/s</td> <td>Gallons/Second</td> </tr> <tr> <td>L/min</td> <td>Liters/Minute</td> <td>gal/min</td> <td>Gallons/Minute</td> </tr> <tr> <td>L/h</td> <td>Liters/Hour</td> <td>gal/h</td> <td>Gallons/Hour</td> </tr> <tr> <td>m³/s</td> <td>Cubic Meters/Second</td> <td>MG/d</td> <td>MillionGallons/Day</td> </tr> <tr> <td>m³/min</td> <td>Cubic Meters/Minute</td> <td>IG/s</td> <td>ImperialGallons/Second</td> </tr> <tr> <td>m³/h</td> <td>Cubic Meters/Hour</td> <td>IG/min</td> <td>ImperialGallons/Minute</td> </tr> <tr> <td>ft³/s</td> <td>Cubic Feet/Second</td> <td>IG/h</td> <td>ImperialGallons/Hour</td> </tr> <tr> <td>ft³/m</td> <td>Cubic Feet/Minute</td> <td>oz/min</td> <td>Ounce/Minute</td> </tr> <tr> <td>ft³/h</td> <td>Cubic Feet/Hour</td> <td>bbl/min</td> <td>Barrel/Minute</td> </tr> </tbody> </table>	<i>Display</i>	<i>Flow Unit</i>	<i>Display</i>	<i>Flow Unit</i>	L/s	Liters/Second	gal/s	Gallons/Second	L/min	Liters/Minute	gal/min	Gallons/Minute	L/h	Liters/Hour	gal/h	Gallons/Hour	m ³ /s	Cubic Meters/Second	MG/d	MillionGallons/Day	m ³ /min	Cubic Meters/Minute	IG/s	ImperialGallons/Second	m ³ /h	Cubic Meters/Hour	IG/min	ImperialGallons/Minute	ft ³ /s	Cubic Feet/Second	IG/h	ImperialGallons/Hour	ft ³ /m	Cubic Feet/Minute	oz/min	Ounce/Minute	ft ³ /h	Cubic Feet/Hour	bbl/min	Barrel/Minute
<i>Display</i>	<i>Flow Unit</i>	<i>Display</i>	<i>Flow Unit</i>																																						
L/s	Liters/Second	gal/s	Gallons/Second																																						
L/min	Liters/Minute	gal/min	Gallons/Minute																																						
L/h	Liters/Hour	gal/h	Gallons/Hour																																						
m ³ /s	Cubic Meters/Second	MG/d	MillionGallons/Day																																						
m ³ /min	Cubic Meters/Minute	IG/s	ImperialGallons/Second																																						
m ³ /h	Cubic Meters/Hour	IG/min	ImperialGallons/Minute																																						
ft ³ /s	Cubic Feet/Second	IG/h	ImperialGallons/Hour																																						
ft ³ /m	Cubic Feet/Minute	oz/min	Ounce/Minute																																						
ft ³ /h	Cubic Feet/Hour	bbl/min	Barrel/Minute																																						
Totalizer Unit 	<p>This parameter establishes the units of measure for the totalizers.</p> <table border="1"> <thead> <tr> <th><i>Display</i></th> <th><i>Totalizer Unit</i></th> <th><i>Display</i></th> <th><i>Totalizer Unit</i></th> </tr> </thead> <tbody> <tr> <td>L</td> <td>Liters</td> <td>MG</td> <td>Million Gallons</td> </tr> <tr> <td>hL</td> <td>Hectoliter</td> <td>IG</td> <td>Imperial Gallons</td> </tr> <tr> <td>m³</td> <td>Cubic Meters</td> <td>bbl</td> <td>Barrel</td> </tr> <tr> <td>ft³</td> <td>Cubic Feet</td> <td>oz</td> <td>Fluid Ounces</td> </tr> <tr> <td>gal</td> <td>U.S. Gallons</td> <td>ac/ft</td> <td>Acre per foot</td> </tr> </tbody> </table>	<i>Display</i>	<i>Totalizer Unit</i>	<i>Display</i>	<i>Totalizer Unit</i>	L	Liters	MG	Million Gallons	hL	Hectoliter	IG	Imperial Gallons	m ³	Cubic Meters	bbl	Barrel	ft ³	Cubic Feet	oz	Fluid Ounces	gal	U.S. Gallons	ac/ft	Acre per foot																
<i>Display</i>	<i>Totalizer Unit</i>	<i>Display</i>	<i>Totalizer Unit</i>																																						
L	Liters	MG	Million Gallons																																						
hL	Hectoliter	IG	Imperial Gallons																																						
m ³	Cubic Meters	bbl	Barrel																																						
ft ³	Cubic Feet	oz	Fluid Ounces																																						
gal	U.S. Gallons	ac/ft	Acre per foot																																						
Full Scale Flow 	<p>This parameter sets the maximum flow the system is expected to measure. This parameter has influence on other system parameters like analog output or low flow cutoff.</p> <p>In terms of flow velocity, the meter's range is 0.3...12 m/sec.</p> <p>The full scale flow is valid for both flow directions.</p> <p>NOTE: If the flow rate exceeds the full scale setting, an error message indicates that the configured full scale range has been exceeded.</p>																																								
Low Flow Cutoff 	<p>Low Flow Cutoff defines the threshold at which flow measurement will be forced to zero. The cutoff value can be from 0...10% of the full scale flow. Increasing this threshold will help prevent false readings during "no flow" conditions, possibly caused by vibrations or liquid fluctuations.</p>																																								
Flow Direction 	<p>Flow direction lets you set the meter to measure forward flow only (Uni-directional) or both forward and reverse flow (Bi-directional).</p> <p>Uni-directional means that the flow is totalized in only one direction. The flow direction is indicated by the arrow printed on the sensor label. In this mode, the two totalizers, T1+ and T2+, can be used as totalizers and resettable day counters.</p> <p>Bi-directional means the flow is totalized in both directions. The totalizers T1+ and T2+ register forward flow and the totalizers T1- and T2- register reverse flow direction. The net totalizers T1N and T2N show the difference between T+ and T-. A change of the flow direction can be signalled by the digital outputs.</p>																																								

Measurement																
Filter 	Median 	The Median Filter (MDN) reduces noise on the measuring signal. The filter level can be adjusted from 7 up to 13 or switched off.														
	Moving Average 	Moving average filter (MAV) smooths out short-term fluctuations. The value can be adjusted from 1 to 200 measuring periods. The delay is calculated: $\text{Delay [s]} = (\text{MAV} - 1) \times T$ The time (T) is given by the adjusted excitation frequency of the meter. <table border="1" style="margin: 10px auto;"> <thead> <tr> <th style="text-align: center;">Excitation frequency [Hz]</th> <th style="text-align: center;">T = Time for filter delay (s)</th> </tr> </thead> <tbody> <tr> <td style="text-align: center;">15</td> <td style="text-align: center;">0.03333</td> </tr> <tr> <td style="text-align: center;">12.5</td> <td style="text-align: center;">0.040</td> </tr> <tr> <td style="text-align: center;">7.5</td> <td style="text-align: center;">0.06666</td> </tr> <tr> <td style="text-align: center;">6.25</td> <td style="text-align: center;">0.080</td> </tr> <tr> <td style="text-align: center;">3.75</td> <td style="text-align: center;">0.13333</td> </tr> <tr> <td style="text-align: center;">3.125</td> <td style="text-align: center;">0.160</td> </tr> </tbody> </table> For example: MAV = 20 and the excitation frequency is 6.25 Hz means T=0.08 s, the delay is 1.52 s.	Excitation frequency [Hz]	T = Time for filter delay (s)	15	0.03333	12.5	0.040	7.5	0.06666	6.25	0.080	3.75	0.13333	3.125	0.160
	Excitation frequency [Hz]	T = Time for filter delay (s)														
15	0.03333															
12.5	0.040															
7.5	0.06666															
6.25	0.080															
3.75	0.13333															
3.125	0.160															
Display 	Moving average filter smooths out short-term fluctuations only for the display. The value can be adjusted from 1 to 200 measuring periods. For calculation of the delay see Moving Average above.															

Input/Outputs Menu

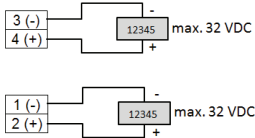
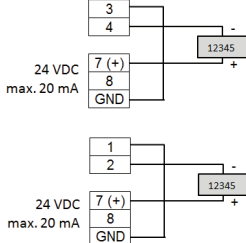
Input/Outputs						
<p>Analog Output</p>	<p>Range</p> <p></p>	<p>This parameter establishes the range of the analog output signal: 0...100% (= full scale). The following current ranges are available.</p> <table border="1" style="margin-left: auto; margin-right: auto;"> <tr> <th style="text-align: center;">Current Output</th> </tr> <tr> <td style="text-align: center;">0...20 mA</td> </tr> <tr> <td style="text-align: center;">4...20 mA</td> </tr> <tr> <td style="text-align: center;">0...10 mA</td> </tr> </table> <div style="display: flex; justify-content: space-around; margin-top: 10px;"> <div style="text-align: center;"> <p>Analog output active</p>  </div> <div style="text-align: center;"> <p>Analog output passive</p>  </div> </div> <p>NOTE: When an error message is displayed, the current is set according to the programming of the Alarm Mode below. When you select <i>Bi-directional</i> operation, you can signal flow direction via digital outputs.</p>	Current Output	0...20 mA	4...20 mA	0...10 mA
Current Output						
0...20 mA						
4...20 mA						
0...10 mA						
<p>Alarm Mode</p>	<p></p>	<p>This parameter configures the behavior of the analog output during alarm conditions. Three options exist for this parameter: OFF, LOW and HIGH.</p> <p>OFF: Analog signal is based on flow rate and always within the configured range.</p> <p>LOW: During alarm conditions, the analog signal will be 2 mA less than the configured lower range. (only on 4...20 mA range)</p> <p>HIGH: During alarm conditions, the analog signal will be 2 mA more than the configured upper range.</p> <p>For example, if the analog range is 4...20 mA and the alarm mode is set to HIGH, then during a full scale flow alarm condition, the analog output current will be 22 mA.</p>				
<p>Digital Input</p>	<p></p>	<p>Digital input lets you reset totalizers (Remote reset) or interrupt flow measurement (PosZeroReturn).</p> <ul style="list-style-type: none"> • Remote Reset – Clears totalizer T2 (Uni-directional) • Pos Zero Return – Forces flow rate to zero (does not totalize) <p>Input switching is provided by applying an external potential of 5...30V DC</p> <div style="margin-bottom: 10px;">  </div> <p>or by an internal voltage source of 24V DC (analog output if not used).</p> <div>  </div>				

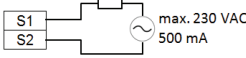

Inputs/Outputs		
<p>Digital Outputs</p> <p>(continued on next page)</p>	<p>Pulse Width</p> 	<p>This parameter establishes the “On” duration of the transmitted pulse. The configurable range is 0...2000 ms. If 0 ms is configured, pulse width is automatically adapted depending on pulse frequency (pulse/pause ratio 1:1). During the configuration, the program checks if pulses/unit and pulse width are in accordance with full scale defined. If not, an error alarm is displayed. In case of an error alarm, scale, pulse width or full scale need to be adapted.</p>
	<p>Pulses/unit</p> 	<p>The pulses/unit parameter lets you set the number of pulses per unit of measure that will be transmitted. The maximum output frequency of 10,000 pulses/sec. (10 kHz) must not be exceeded.</p> <p>For example, assuming the unit of measure is gallons:</p> <ul style="list-style-type: none"> Setting the pulses/unit to 1 will transmit 1 pulse every gallon Setting the pulses/unit to 0.01 will transmit 1 pulse every 100 gallons <p>You must configure pulses/unit if the function of the selected output is to be forward, reverse or AMR pulse.</p>
	<p>Frequency</p> 	<p>This parameter establishes the digital output as frequency output. The full scale frequency configurable range is 0.01...10,000 Hz.</p>
	<p>Set Min./Max.</p> 	<p>The Flow Set Point (min., max.) establishes, as a percentage of full scale flow, the threshold at which the output alarm will be activated. You can freely select thresholds in 1% steps. Flow rates below/above the threshold will activate the output alarm.</p>
	<p>Preset Amount</p> 	<p>Preset amount lets you set the reset value for the associated PS totalizer when the digital input is set to Batch Reset. You can configure preset amount in the adjusted volume unit.</p> <p>Preset amount is counted down from the configured value to 0 and a digital output shows that the preset amount has been reached.</p>
	<p>Out 1 Function Out 2 Function</p>  <p>(continued on next page)</p>	<p>From the sub-menus <i>Out 1 Function</i> and <i>Out 2 Function</i>, you can configure functional operation of the 2 digital outputs. For example, you can select “forward pulse” for the digital output and define the pulses-per-totalizer unit via “pulse scale.”</p> <p>The two outputs can be operated as open collector passively or actively.</p> <p style="text-align: center;">Passive output: Active output (if analog output is not used):</p> <div style="display: flex; justify-content: space-around;"> <div style="text-align: center;">  </div> <div style="text-align: center;">  </div> </div>

Inputs/Outputs																																																										
Digital Outputs (continued from previous page)	Out 1 Function Out 2 Function  (continued from previous page)	Solid-State Relay The solid-state relay is functionally linked with Output 2. See the table below.																																																								
		The following functions can be selected for Outputs 1 and 2 as well as for the solid-state relay. The solid-state relay function is linked with the function of Output 2.	<table border="1"> <thead> <tr> <th>Function</th> <th>Meaning</th> <th>Out1</th> <th>Out2 / Solid-State Relay</th> </tr> </thead> <tbody> <tr> <td>Off</td> <td>Digital output is switched off.</td> <td>X</td> <td>X</td> </tr> <tr> <td>Test</td> <td>Used only for the Verification Device.</td> <td>X</td> <td>X</td> </tr> <tr> <td>Comparator</td> <td>TBD</td> <td>X</td> <td>X</td> </tr> <tr> <td>Empty Pipe Error</td> <td>Indicates when a pipe is empty.</td> <td>X</td> <td>X</td> </tr> <tr> <td>Error Alarm</td> <td>Indicates a meter error condition.</td> <td>X</td> <td>X</td> </tr> <tr> <td>Forward Pulses</td> <td>Generates pulses during forward flow conditions.</td> <td>X</td> <td>X</td> </tr> <tr> <td>Reverse Pulses</td> <td>Generates pulses during reverse flow conditions.</td> <td>X</td> <td>X</td> </tr> <tr> <td>Direction</td> <td>Indicates current flow direction.</td> <td>X</td> <td>X</td> </tr> <tr> <td>Loopback</td> <td>Shows the status of the digital input.</td> <td>X</td> <td>X</td> </tr> <tr> <td>Min./Max. Alarm</td> <td>Establishes, as a percentage of full scale flow, the threshold at which the output alarm will be activated. Flow rates below or above the threshold will activate the output alarm.</td> <td>X</td> <td>X</td> </tr> <tr> <td>Frequency</td> <td>TBD</td> <td>X</td> <td>X</td> </tr> <tr> <td>Rotary Encoder</td> <td>TBD</td> <td>X</td> <td>X</td> </tr> <tr> <td>Preset</td> <td>Indicates when a preset batch amount has been realized.</td> <td>X</td> <td>X</td> </tr> </tbody> </table>	Function	Meaning	Out1	Out2 / Solid-State Relay	Off	Digital output is switched off.	X	X	Test	Used only for the Verification Device.	X	X	Comparator	TBD	X	X	Empty Pipe Error	Indicates when a pipe is empty.	X	X	Error Alarm	Indicates a meter error condition.	X	X	Forward Pulses	Generates pulses during forward flow conditions.	X	X	Reverse Pulses	Generates pulses during reverse flow conditions.	X	X	Direction	Indicates current flow direction.	X	X	Loopback	Shows the status of the digital input.	X	X	Min./Max. Alarm	Establishes, as a percentage of full scale flow, the threshold at which the output alarm will be activated. Flow rates below or above the threshold will activate the output alarm.	X	X	Frequency	TBD	X	X	Rotary Encoder	TBD	X	X	Preset	Indicates when a preset batch amount has been realized.	X
Function	Meaning	Out1	Out2 / Solid-State Relay																																																							
Off	Digital output is switched off.	X	X																																																							
Test	Used only for the Verification Device.	X	X																																																							
Comparator	TBD	X	X																																																							
Empty Pipe Error	Indicates when a pipe is empty.	X	X																																																							
Error Alarm	Indicates a meter error condition.	X	X																																																							
Forward Pulses	Generates pulses during forward flow conditions.	X	X																																																							
Reverse Pulses	Generates pulses during reverse flow conditions.	X	X																																																							
Direction	Indicates current flow direction.	X	X																																																							
Loopback	Shows the status of the digital input.	X	X																																																							
Min./Max. Alarm	Establishes, as a percentage of full scale flow, the threshold at which the output alarm will be activated. Flow rates below or above the threshold will activate the output alarm.	X	X																																																							
Frequency	TBD	X	X																																																							
Rotary Encoder	TBD	X	X																																																							
Preset	Indicates when a preset batch amount has been realized.	X	X																																																							
	Out Type 1 and Out Type 2 	This parameter lets you set the output switch to normally open or normally closed. If normally open is selected, the output switch is open (no current) when the output is inactive, and closed (current flows) when the output is active. If normally closed is selected, the output switch is closed (current flows) when the output is inactive, and open (no current) when the output is active.																																																								
Simulation 		Flow Simulation provides analog and digital output simulation based on a percentage of the full scale flow in cases where no real flow is occurring. The range of simulation is -100...100% in steps of 10% of the full scale flow. This function still remains active once you exit the menu. It is necessary to set it to OFF to deactivate it. If the simulation is still active, the letter "S" will be displayed in the measuring mode.																																																								

Totalizer Reset Menu

Totals	
Clear T2 	The Uni-directional Totalizer T2 is reset within the menu manager.

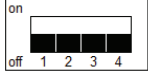
Communication Menu

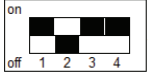
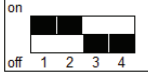
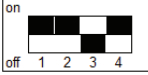
Communication: Port Settings																											
Interfaces	Modbus RTU	RS-232, RS-485 and RS-422 with Modbus RTU. See <i>Figure 28 on page 21</i> for wiring diagram.																									
		<table border="1" style="margin-left: 20px;"> <thead> <tr> <th rowspan="2">Connector Label</th> <th colspan="3">RS Interfaces</th> </tr> <tr> <th>422</th> <th>232</th> <th>485</th> </tr> </thead> <tbody> <tr> <td>A</td> <td>A</td> <td>RxD</td> <td>—</td> </tr> <tr> <td>B</td> <td>B</td> <td>—</td> <td>—</td> </tr> <tr> <td>Z</td> <td>Z</td> <td>TxD</td> <td>B</td> </tr> <tr> <td>Y</td> <td>Y</td> <td>—</td> <td>A</td> </tr> <tr> <td>G</td> <td colspan="3">G (GND)</td> </tr> </tbody> </table> <p>Mode can be configured by DIP switches also if Termination is ON or OFF.</p> <div style="margin-left: 20px;">  RS 232  RS 422 Term. OFF  RS 422 Term. ON  RS 485 Term. OFF  RS 485 Term. ON </div>	Connector Label	RS Interfaces			422	232	485	A	A	RxD	—	B	B	—	—	Z	Z	TxD	B	Y	Y	—	A	G	G (GND)
Connector Label	RS Interfaces																										
	422	232	485																								
A	A	RxD	—																								
B	B	—	—																								
Z	Z	TxD	B																								
Y	Y	—	A																								
G	G (GND)																										
M-Bus	Address	Additional hardware required.																									
	HART	Additional hardware required.																									
Modbus	Address	This parameter configures the Modbus address in the range from 1...247.																									
	RS-232	Baud rate: 1200, 2400, 4800, 9600, 19200, 38400 Bd																									
	RS-422 RS-485	Parity: Even, Odd, Mark, None																									
M-Bus	Address	0...250																									
HART	Physical Signaling	Bell202 Current or RS-485																									
	Polling Address	Configure the polling address																									
Ethernet	Modbus TCP/IP with MEAP-Header																										
	IP Address	IPv4-Address																									
	IP Mask	IPv4 subnetting reference																									
	IP Gateway	Gateway address																									
	MAC Address	Media-Access-Control-Address																									
ADE	Control	On or Off																									
	Protocol	1 standard message 2 extended messages																									
	Dial	4...9																									
	Resolution	0.001 / 0.01 / 0.1 / 1 / 10 / 100 / 1000 / 10,000																									

Miscellaneous Menu

Miscellaneous													
Power Up	The number of times that the unit has been powered on.												
Settling Time	Measures settling of coils and must be less than one quarter of the excitation period. Zero ms if no sensor is connected.												
Language	This parameter allows changing the current language. English is the default setting. The following languages are supported: German (Deutsch), Czech (Cestina), Spanish (Espanol), French (Francais), Russian (Россия), Italian (Italiano).												
Date	Set date of the system in the format day, month, year [DD.MM.YY] used for data logging.												
Time	Set time of the system in the format hour, minutes, seconds [HH.MM.SS] used for data logging.												
EEPROM	Delete all data logging information from the EEPROM.												
Polar Voltage	Measure electrode polarizing voltage in $\pm V$ (only for service purpose).												
Display Rotation	The Display can be rotated to 0°, 90°, 180° and 270°.												
Contrast	The contrast of the display can be adjusted between 14 (low) and 49 (high).												
Datalog Period	<p>The data logging period can be adjusted to the following increments:</p> <ul style="list-style-type: none"> • Every 15 min / 1 h / 6 h / 12 h / 24 h <p>There is a 500 kB memory available with about 30,000 data records for data logging. The logging capacity is as follows (Uni-directional mode):</p> <table border="1"> <thead> <tr> <th>Time Period</th> <th>Duration</th> </tr> </thead> <tbody> <tr> <td>15 min</td> <td>up to 312 days</td> </tr> <tr> <td>1 h</td> <td>up to 1250 days</td> </tr> <tr> <td>6 h</td> <td>up to 20 years</td> </tr> <tr> <td>12 h</td> <td>up to 40 years</td> </tr> <tr> <td>24 h</td> <td>up to 80 years</td> </tr> </tbody> </table> <p>Startup, configuration, and error events that are logged can reduce the data logging capacity. Logging in Bi-directional mode reduces the logging capacity by about 40%. The logging information can be downloaded by a PC program, which can be ordered with the following part number: 67354-010.</p>	Time Period	Duration	15 min	up to 312 days	1 h	up to 1250 days	6 h	up to 20 years	12 h	up to 40 years	24 h	up to 80 years
Time Period	Duration												
15 min	up to 312 days												
1 h	up to 1250 days												
6 h	up to 20 years												
12 h	up to 40 years												
24 h	up to 80 years												
Log	Off, On and Preset												

Information Menu

Info	
Serial Number	Serial number of the electronic board.
Version	Software version of the device.
Compilation Date	Date of the software version.
OTP CRC	Checksum of the software update.
Application CRC	Checksum of the application.

PIN Menu

Setting Personal Identification Numbers (PINs)

The M1000 offers three levels of access to the individual menus: **A**dministrative, **S**ervice and **U**ser level.

The applicable security level for each menu option is indicated as follows:



Administrative



Service



User

The M1000 security feature allows the option to restrict access to the meter by way of a 6-digit Personal Identification Number (PIN). No PINs are set at the factory. The system administrator can set up a single PIN for each of the three different levels of access:

1. To activate password protection, navigate to the *PIN* menu. Set *Control* to **ON**.
2. Enter the *Login* menu and login using the password 000000.
3. Return to the *PIN* menu and enter [User], [Service] and [Admin] passwords.

Logging In

Once the password protection has been activated, enter your PIN under *Login*.

NOTE: The *Login* screen is available only after *Control* has been set to **ON**.

Once logged in, the unlock icon  appears.





NOTE: A **PIN Error** message displays if the incorrect PIN is entered.

The PIN grants you access to either Administrator, Service or User level with the respective access rights (marked with A, S and U in this manual). You can now move to the menu and enter your parameters.

Without a login, you can read all parameters, but cannot change them.

Logging Out

To log out, enter an incorrect PIN, then press **EXIT SAVE**.

PIN	
Control 	Activate and deactivate the PIN.
User 	Users logged in with this PIN have access to user-level procedures. Users at this level do not have access to service or admin functions.
Service 	Users logged in with this PIN have access to both service and user-level procedures. Users at this level do not have access to admin functions.
Admin 	Users logged in with this PIN have access to all procedures. Users at this level have full access to the meter.

Login Screen

Login	
Login	This screen is available only after the password protection (PIN Control) has been set to ON. Enter your 6-digit password.

MAINTENANCE

Mandatory, routine or scheduled maintenance should not be required for the M1000 Mag Meter electronics or flow tube after proper installation. However, some occurrences may require you to perform the following:

- Flow tube and electrode cleaning
- General cleaning
- Circuit board replacement

WARNING

DO NOT CLEAN COMPONENTS INSIDE THE TRANSMITTER OR JUNCTION BOX.

AVERTISSEMENT

NE NETTOYEZ PAS LES COMPOSANTES À L'INTÉRIEUR DE L'AMPLIFICATEUR OU DE LA BOÎTE DE JONCTION.

Cleaning the Flow Tube and Electrode

At times flow tube, electrodes, transmitter/junction box housings and the transmitter window may need periodic cleaning, depending on process fluid properties, fluid flow rate and surrounding environment.

Clean the flow tube and electrodes by following the material handling and cleaning procedures documented in the Material Safety Data Sheet (MSDS) guidelines for the products(s) that were in contact with the flow tube and electrodes.

Should flow tube and/or electrode cleaning become necessary:

1. Disconnect sensor from pipeline.
2. Clean electrodes according to MSDS guidelines.
3. Reconnect sensor to pipeline.

General Cleaning

Switch off all units and isolate from mains before cleaning.

Clean using a damp cloth. Do not use liquid or aerosol cleaners.

TROUBLESHOOTING

The M1000 mag meter is designed for many years of optimal performance. However, should it malfunction, there are certain things that we recommend you check before contacting our Technical Support department or your local Badger Meter Representative.

Errors and Warnings

NOTE: The M1000 display flashes whenever an error is detected.

Description	Possible Cause	Recommended Action
Coil disconnected	<ul style="list-style-type: none"> Meter not connected. Connection to meter interrupted. 	Check if meter is connected and make sure that cable connection is not interrupted or contact Badger Meter Technical Support.
Coil shorted	Coil cables shorted.	Check coil cables.
Empty pipe	Pipe may not be full.	Make sure that pipe is always filled at the measuring point.
	Medium with low conductivity.	Calibration required.
	Cable broken or disconnected.	Check the cable for the empty pipe signal.
Range	Actual flow rate is exceeding the programmed full scale by more than 100%.	Reduce flow rate or increase the programmed full scale.
Pulse output	Pulse rate exceeds the maximum.	Reduce pulse scale (pulse/unit) and/or reduce pulse width configuration.
AD error	Input signal from sensor too high.	Check the grounding scheme of the meter installation. See <i>"Meter Grounding"</i> on page 15.
Excitation frequency	The excitation frequency is too high for this sensor.	Decrease the excitation frequency in the Meter Setup.
EEPROM	Configuration file is missing.	Contact Badger Meter Technical Support.
Configuration	Configuration file is corrupted.	Contact Badger Meter Technical Support.
Low Battery	Low backup battery (memory).	Contact Badger Meter Technical Support
Measure Timeout	Measurement was not completed within specific time.	Contact Badger Meter Technical Support.

Some frequently occurring situations:

Description	Possible Cause	Recommended Action
Meter does not function	No auxiliary power.	Apply auxiliary power.
	Fuse is defective.	Replace fuse.
Fluid is flowing, however display shows zero	Signal cable is not connected or connection is interrupted.	Check signal cable.
	Sensor installed opposite to forward flow direction (see arrow on type plate).	Turn sensor by 180°.
	Connection cable for coils or electrodes mixed-up.	Check connection cable.
Inaccurate measurement	Wrong parameters.	Check parameters (sensor, transmitter and size) per <i>"Connecting an AquaCUE/BEACON Encoder Interface to the M1000 Meter"</i> on page 39.
	Pipe not completely full.	Check if the measuring pipe is completely full.

Repair of Faults

⚠ WARNING

Disconnect all units from power supply and have it repaired by a qualified service person if any of the following occurs:

If any power cord or plug is damaged or frayed.

If a unit does not operate normally when operating instructions are followed.

If a unit is exposed to rain/water or if any liquid has been spilled into it.

If a unit has been dropped or damaged.

If a unit shows a change in performance, indicating a need for service.

LED Status Indicators

When the LEDs on the circuit board are active, they indicate the status of the device.

LED	Device Status	Label on PCB
LED1	Coil loop connected	COIL
LED2	Communication – receiving	RX
LED3	Communication – transmitting	TX
LED5	Flash memory activity	DISK
LED6	Digital output #1	OUT 1
LED7	Digital output #2	OUT 2
LED8	Digital input	INPUT
LED10	Power ON	POWER
LED13	USB, HOST mode	USB

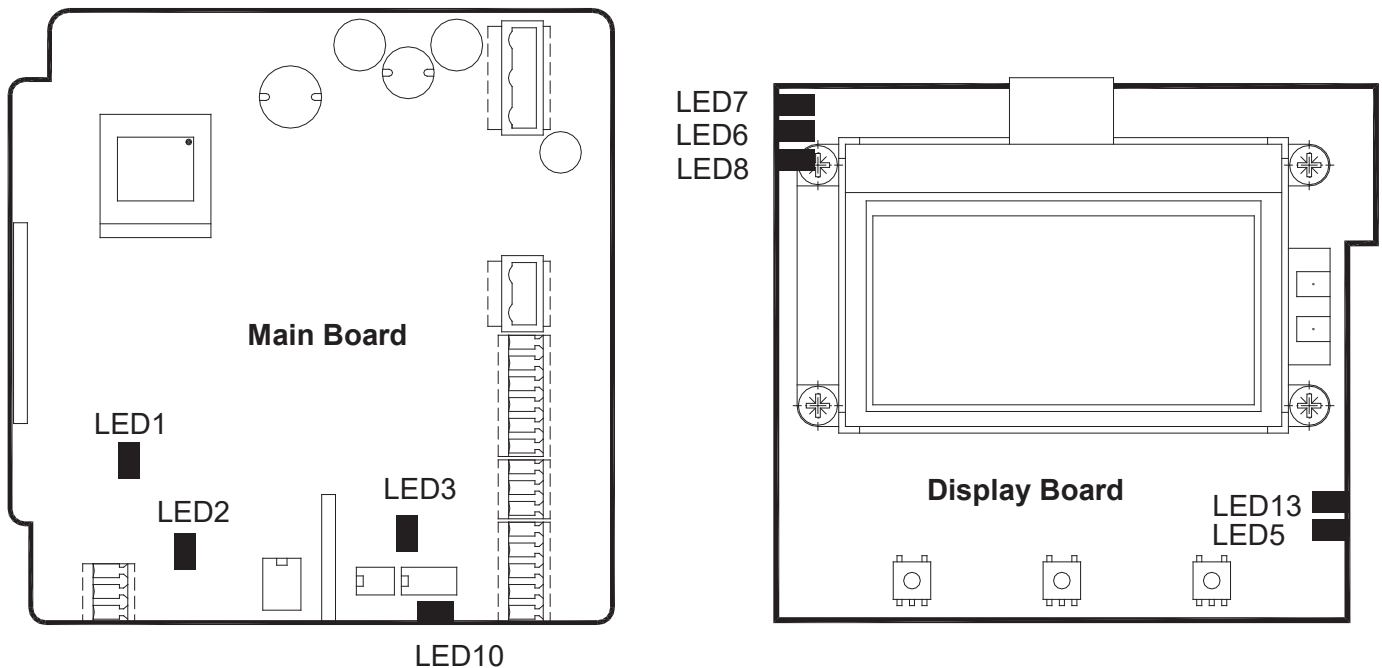

Figure 30: LED locations

REPLACING METER ELECTRONICS

⚠ WARNING

DISCONNECT AUXILIARY POWER BEFORE OPENING BODY COVER.

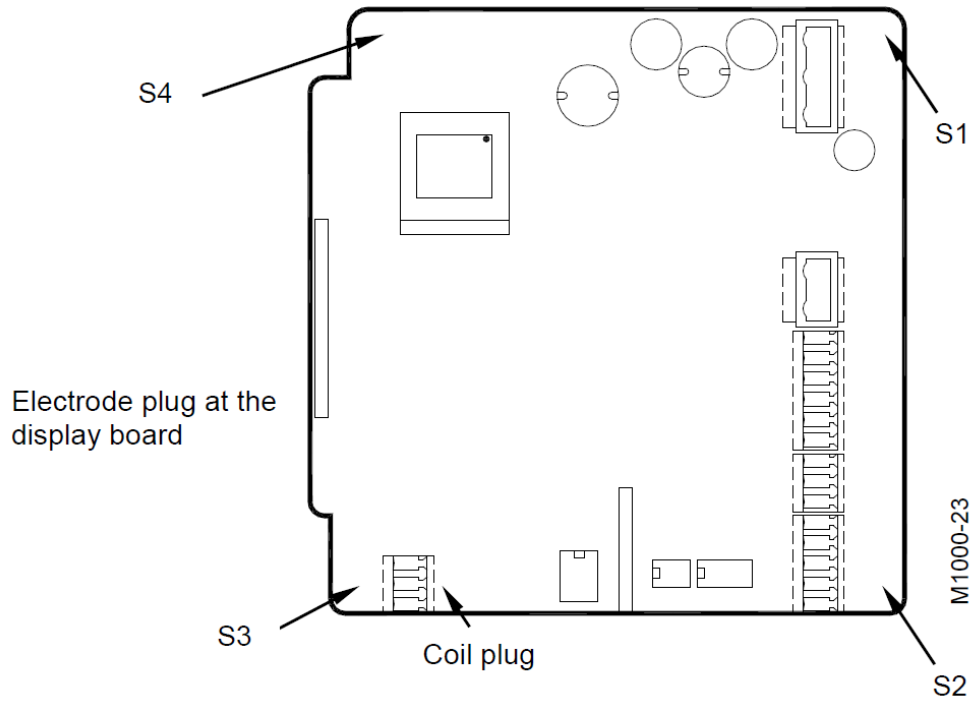

Figure 31: Screw locations

1. Pull out all plugs. Loosen screws S1...S4 and remove circuit board.
2. Insert new circuit board and fasten in place by replacing screws S1...S4. Insert plugs that were previously removed.
3. If necessary, configure new circuit board to work with the meter (sensor, size).

CONNECTING AN AQUACUE/BEACON ENCODER INTERFACE TO THE M1000 METER

NOTE: Connect the endpoint as described. The endpoint automatically updates within one hour. See the endpoint software user manual for programming information.

Wiring

To connect the endpoint, connect:

M1000 Terminal	Endpoint Wire
Input +	Red (Power/Clock)
Out 1 +	Green (Data)
Out 1 -	Black (Ground)

Connect a jumper wire from Out 1 negative (-) to Input negative (-).

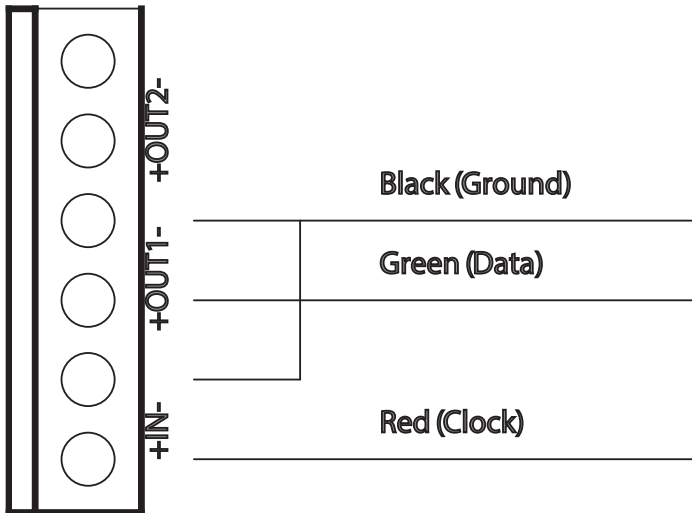

Programming

Changing the following settings configures *Input* and *Output 1* for the endpoint.

To program the M1000 meter for the endpoint to Output #1 (forward flow):

1. Navigate to *COMMUNICATION > ADE > CONTROL*.
2. Use the arrows to change the values, then press **EXIT/SAVE**.
3. Repeat steps 1 and 2 for *Control, Protocol, Dials* and *Resolution* (the *Resolution* range is 0.0001...10,000).
4. Press **EXIT/SAVE**.

SPECIFICATIONS

NOTE: DN represents nominal diameter in mm.

Sensor Type II Specifications

Size	1/4...20 in. (DN 6...500)		
Process Connections	Flange: DIN, ANSI, JIS, AWWA etc.		
Nominal Pressure	Up to 1450 psi (100 bar) (PED)		
Protection Class	IP 67, IP 68 optional		
Minimum Conductivity	5 μ S/cm (20 μ S/cm demineralized water)		
Liners	Hard/soft rubber	1 in. (DN 25) and up	32...176° F (0...80° C)
	PFA	1/4...3/8 in. (DN 6...10)	-40...302° F (-40...150° C)
	PTFE	1/2...20 in. (DN 15...500)	-40...302° F (-40...150° C)
Electrodes	Hastelloy C (Standard)	Platinum/Gold platinized	
	Tantalum	Platinum/Rhodium	
Body	Steel/stainless steel optional		
Grounding Rings	Stainless steel		

Process Connection Flange Remote Version
in. (mm)

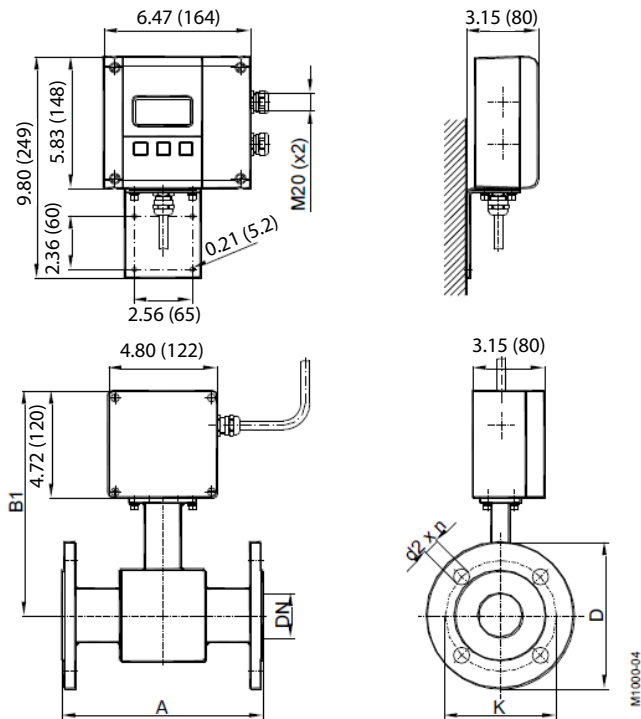

Process Connection Flange Mounted Version
in. (mm)

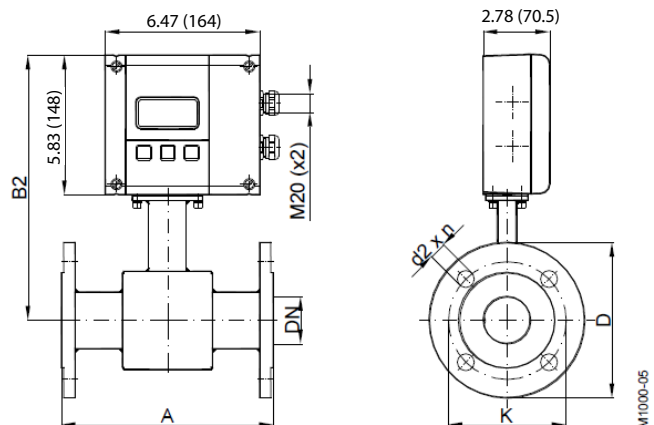

Size		A Std* in. (mm)	A ISO** in. (mm)	B1 in. (mm)	B2 in. (mm)	ANSI Flanges			DIN Flanges			Finish Est. Wt. lb (kg)
Inches	DN					D in. (mm)	K in. (mm)	d2xn in. (mm)	D in. (mm)	K in. (mm)	d2xn in. (mm)	
1/4 in.	6	6.69 (170)	—	8.98 (228)	10.08 (256)	3.50 (88.9)	2.37 (60.3)	0.63 × 4 (15.9 × 4)	3.54 (90)	2.37 (60)	0.55 × 4 (14 × 4)	9.04 (4.1)
5/16 in.	8	6.69 (170)	—	8.98 (228)	10.08 (256)	3.50 (88.9)	2.37 (60.3)	0.63 × 4 (15.9 × 4)	3.54 (90)	2.37 (60)	0.55 × 4 (14 × 4)	9.04 (4.1)
3/8 in.	10	6.69 (170)	—	8.98 (228)	10.08 (256)	3.50 (88.9)	2.37 (60.3)	0.63 × 4 (15.9 × 4)	3.54 (90)	2.37 (60)	0.55 × 4 (14 × 4)	9.04 (4.1)
1/2 in.	15	6.69 (170)	7.87 (200)	9.37 (238)	10.47 (266)	3.50 (88.9)	2.37 (60.3)	0.63 × 4 (15.9 × 4)	3.74 (95)	2.56 (65)	0.55 × 4 (14 × 4)	9.04 (4.1)
3/4 in.	20	6.69 (170)	7.87 (200)	9.37 (238)	10.47 (266)	3.87 (98.4)	2.75 (69.8)	0.63 × 4 (15.9 × 4)	4.13 (105)	2.95 (75)	0.55 × 4 (14 × 4)	11.24 (5.1)
1 in.	25	8.86 (225)	7.87 (200)	9.37 (238)	10.47 (266)	4.25 (107.9)	3.13 (79.4)	0.63 × 4 (15.9 × 4)	4.53 (115)	3.35 (85)	0.55 × 4 (14 × 4)	16.76 (7.6)
1-1/4 in.	32	8.86 (225)	7.87 (200)	9.96 (253)	11.06 (281)	4.63 (117.5)	3.50 (88.9)	0.63 × 4 (15.9 × 4)	5.51 (140)	3.94 (100)	0.71 × 4 (18 × 4)	18.96 (8.6)
1-1/2 in.	40	8.86 (225)	7.87 (200)	9.96 (253)	11.06 (281)	5.00 (127)	3.87 (98.4)	0.63 × 4 (15.9 × 4)	5.91 (150)	4.33 (110)	0.71 × 4 (18 × 4)	20.06 (9.1)
2 in.	50	8.86 (225)	7.87 (200)	9.96 (253)	11.06 (281)	6.00 (152.4)	4.75 (120.6)	0.75 × 4 (19 × 4)	6.50 (165)	4.92 (125)	0.71 × 4 (18 × 4)	24.47 (11.1)
2-1/2 in.	65	11.02 (280)	7.87 (200)	10.67 (271)	11.77 (299)	7.00 (177.8)	5.5 (139.7)	0.75 × 4 (19 × 4)	7.28 (185)	5.71 (145)	0.71 × 8 (18 × 8)	50.92 (23.1)
3 in.	80	11.02 (280)	7.87 (200)	10.67 (271)	11.77 (299)	7.50 (190.5)	6.00 (152.4)	0.75 × 4 (19 × 4)	7.87 (200)	6.30 (160)	0.71 × 8 (18 × 8)	53.13 (24.1)
4 in.	100	11.02 (280)	9.84 (250)	10.94 (278)	12.05 (306)	9.00 (228.6)	7.50 (190.5)	0.75 × 8 (19 × 8)	8.66 (220)	7.09 (180)	0.71 × 8 (18 × 8)	55.34 (25.1)
5 in.	125	15.75 (400)	9.84 (250)	11.73 (298)	12.83 (326)	10.00 (254)	8.50 (215.9)	0.85 × 8 (22.2 × 8)	9.84 (250)	8.27 (210)	0.71 × 8 (18 × 8)	56.44 (25.6)
6 in.	150	15.75 (400)	11.81 (300)	12.20 (310)	13.31 (338)	11.00 (279.4)	9.50 (241.3)	0.85 × 8 (22.2 × 8)	11.22 (285)	9.45 (240)	0.87 × 8 (22 × 8)	58.64 (26.6)
8 in.	200	15.75 (400)	13.78 (350)	13.31 (338)	14.41 (366)	13.5 (342.9)	11.75 (298.4)	0.85 × 8 (22.2 × 8)	13.39 (340)	11.61 (295)	0.87 × 12 (22 × 12)	85.10 (38.6)
10 in.	250	19.69 (500)	17.72 (450)	14.25 (362)	15.35 (390)	16.00 (406.4)	14.25 (361.9)	1.00 × 12 (25.4 × 12)	15.55 (395)	13.78 (350)	0.87 × 12 (22 × 12)	—
12 in.	300	19.69 (500)	19.69 (500)	16.73 (425)	17.83 (453)	19.00 (482.6)	17.00 (431.8)	1.00 × 12 (25.4 × 12)	17.52 (445)	15.75 (400)	0.87 × 12 (22 × 12)	—
14 in.	350	19.69 (500)	21.65 (550)	17.72 (450)	18.82 (478)	21.00 (533.4)	18.75 (476.2)	1.13 × 12 (28.6 × 12)	19.88 (505)	18.11 (460)	0.87 × 16 (22 × 16)	—
16 in.	400	23.62 (600)	23.62 (600)	18.70 (475)	19.80 (503)	23.5 (596.9)	21.25 (539.7)	1.13 × 16 (28.6 × 16)	22.24 (565)	20.28 (515)	1.02 × 16 (26 × 16)	—
18 in.	450	23.62 (600)	—	19.69 (500)	20.79 (528)	25.00 (635.0)	22.75 (577.8)	1.25 × 16 (31.7 × 16)	24.21 (615)	22.24 (565)	1.02 × 20 (26 × 20)	—
20 in.	500	23.62 (600)	—	20.67 (525)	21.42 (554)	27.50 (698.5)	25.00 (635.0)	1.25 × 20 (31.7 × 20)	26.38 (670)	24.41 (620)	1.02 × 20 (26 × 20)	—
Standard												
ANSI flanges		1/4...20 in. Class 150				Nominal Pressure 284 psi (19.6 bar) at 68° F (20° C) for C-Steel flanges						
DIN flanges		1/4...8 in. (DN 6...200)				Nominal Pressure 232 psi (16 bar)						
		10...20 in. (DN 250...500)				Nominal Pressure 145 psi (10 bar)						
* Standard												
**ISO 20456												

Sensor with Sanitary Process Connections Specifications

Size	3/8...4 in. (DN 10...100)		
Process Connections	Tri-Clamp®, DIN 11851, ISO2852, BS4825 and customer specified.		
Nominal Pressure	Tri-Clamp connection	145 psi (10 bar)	
	DIN 11851 connection	230 psi (16 bar)	
Protection Class	IP 67, IP 68 optional		
Minimum Conductivity	5 µS/cm (20 µS/cm demineralized water)		
Liners	PTFE	-40...302° F (-40...150° C)	
Electrodes	Hastelloy C (Standard)	Platinum/Gold Platinized	
	Tantalum	Platinum/Rhodium	
Body	Stainless steel		
Overall Length	Tri-Clamp connection	3/8...2 in. (DN 10...50)	5.71 in. (145 mm)
		2-1/2...4 in. (DN 65...100)	7.87 in. (200 mm)
	DIN 11851 connection	3/8...3/4 in. (DN 10...20)	6.69 in. (170 mm)
		1...2 in. (DN 25...50)	8.86 in. (225 mm)
		2-1/2...4 in. (DN 65...100)	11.02 in. (280 mm)

Tri-Clamp Connection Remote Version
in. (mm)

DIN 11851 Connection Remote Version
in. (mm)

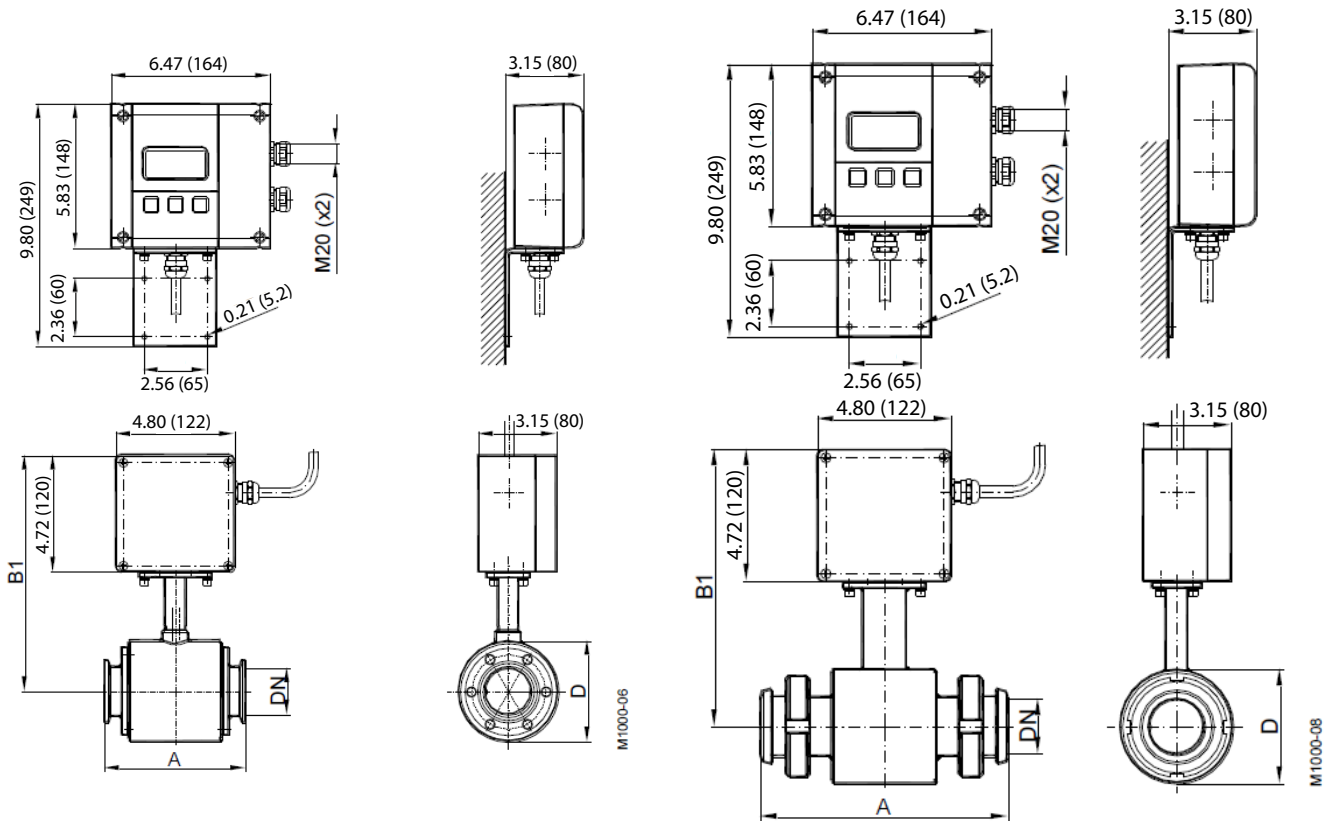

Tri-Clamp Connection Mounted Version
in. (mm)

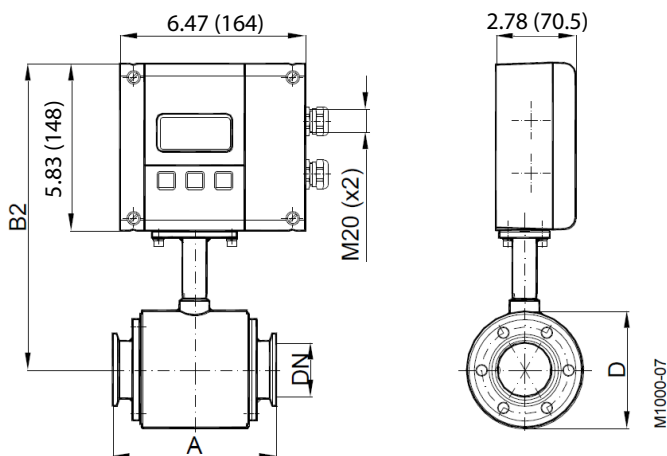

DIN 11851 Connection Mounted Version
in. (mm)

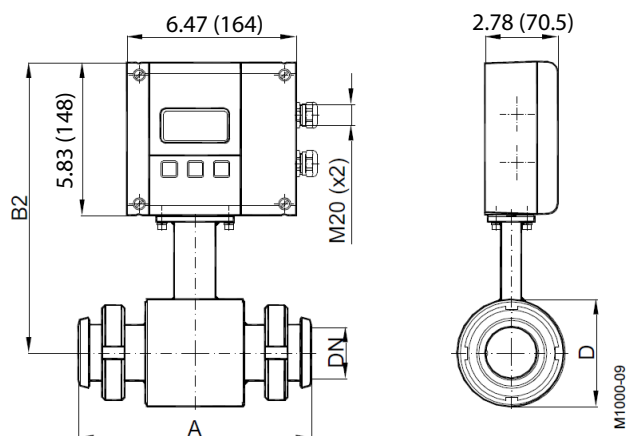

Tri-Clamp		A in. (mm)	B1 in. (mm)	B2 in. (mm)	D in. (mm)
Size	DN				
3/8 in.	10	5.71 (145)	8.98 (228)	10.08 (256)	2.91 (74)
1/2 in.	15	5.71 (145)	8.98 (228)	10.08 (256)	2.91 (74)
3/4 in.	20	5.71 (145)	8.98 (228)	10.08 (256)	2.91 (74)
1 in.	25	5.71 (145)	8.98 (228)	10.08 (256)	2.91 (74)
1-1/2 in.	40	5.71 (145)	9.37 (238)	10.47 (266)	3.70 (94)
2 in.	50	5.71 (145)	9.57 (243)	10.67 (271)	4.09 (104)
2-1/2 in.	65	7.87 (200)	10.08 (256)	11.18 (284)	5.08 (129)
3 in.	80	7.87 (200)	10.28 (261)	11.38 (289)	5.51 (140)
4 in.	100	7.87 (200)	10.59 (269)	11.69 (297)	6.14 (156)

Nominal Pressure 145 psi (10 bar)

DIN 11851		A in. (mm)	B1 in. (mm)	B2 in. (mm)	D in. (mm)
Size	DN				
3/8 in.	10	6.69 (170)	9.37 (238)	10.47 (266)	2.91 (74)
1/2 in.	15	6.69 (170)	9.37 (238)	10.47 (266)	2.91 (74)
3/4 in.	20	6.69 (170)	9.37 (238)	10.47 (266)	2.91 (74)
1 in.	25	8.86 (225)	9.37 (238)	10.47 (266)	2.91 (74)
1-1/4 in.	32	8.86 (225)	9.57 (243)	10.67 (271)	3.31 (84)
1-1/2 in.	40	8.86 (225)	9.76 (248)	10.87 (276)	3.70 (94)
2 in.	50	8.86 (225)	9.96 (253)	11.06 (281)	4.09 (104)
2-1/2 in.	65	11.02 (280)	10.47 (266)	11.57 (294)	5.08 (129)
3 in.	80	11.02 (280)	10.67 (271)	11.77 (299)	5.51 (140)
4 in.	100	11.02 (280)	10.98 (279)	12.09 (307)	6.14 (156)

Nominal Pressure 232 psi (16 bar)

Tri-Clamp Connection Standards BS4825/ISO2852

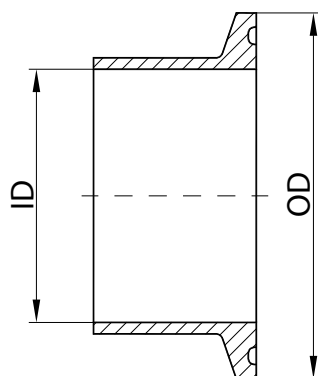

BS4825					ISO2852				
Size	OD		ID		Size	OD		ID	
in.	in.	mm	in.	mm	DN	in.	mm	in.	mm
—	—	—	—	—	10	0.98	25.0	0.55	14.0
1/2	0.98	25.0	0.37	9.4	15	1.99	50.5	0.71	18.1
3/4	0.98	25.0	0.62	15.75	20	1.99	50.5	0.90	22.9
1	1.99	50.5	0.87	22.1	25	1.99	50.5	1.13	28.7
—	—	—	—	—	32	2.52	64.0	1.51	38.4
1-1/2	1.99	50.5	1.37	34.8	40	2.52	64.0	1.74	44.3
2	2.52	64.0	1.87	47.5	50	3.05	77.5	2.22	56.3
2-1/2	3.05	77.5	2.37	60.2	65	3.58	91.0	2.84	72.1
3	3.58	91.0	2.87	72.9	80	4.17	106.0	3.32	84.3
4	4.69	119.0	3.83	97.4	100	5.12	130.0	4.32	109.7

Nominal Pressure 145 psi (10 bar)

Sensor Type III Specifications

Size	1...4 in. (DN 25...100)	
Process Connections	Sandwich connection, (intermediate flange mounting)	
Nominal Pressure	580 psi (40 bar)	
Protective Class	IP 67, IP 68 optional	
Minimum Conductivity	5 µS/cm(20 µS/cm demineralized water)	
Liner	PTFE	-40...302° F (-40...150° C)
Electrodes	Hastelloy C (Standard) Tantalum	Platinum/Gold platinized Platinum/Rhodium
Body	Steel/stainless steel optional	
Grounding Rings	Stainless steel	
Overall Length	1...2 in. (DN 25...50)	3.94 in. (100 mm)
	2-1/2...4 in. (DN 65...100)	5.91 in. (150 mm)

Process Connection Wafer Remote Version in. (mm)

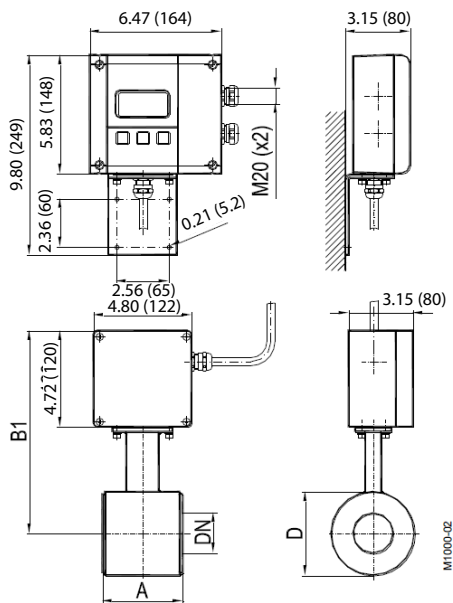

Process Connection Wafer Mounted Version in. (mm)

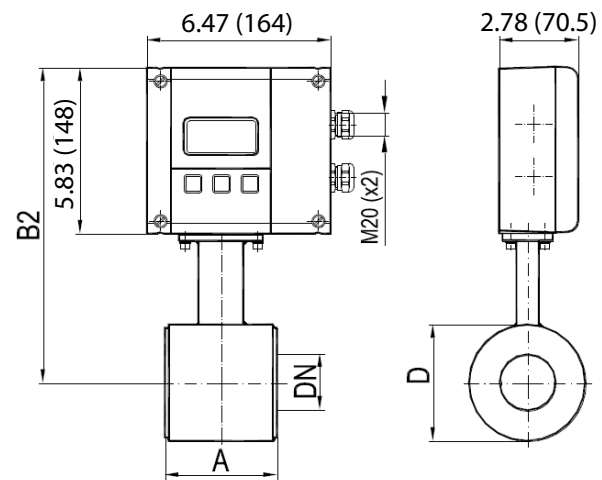

Size		A in. (mm)	B1 in. (mm)	B2 in. (mm)	D in. (mm)
Inches	DN				
1 in.	25	3.94 (100)	9.37 (238)	10.47 (266)	2.91 (74)
1-1/4 in.	32	3.94 (100)	9.57 (243)	10.67 (271)	3.31 (84)
1-1/2 in.	40	3.94 (100)	9.76 (248)	10.87 (276)	3.70 (94)
2 in.	50	3.94 (100)	9.96 (253)	11.06 (281)	4.09 (104)
2-1/2 in.	65	5.91 (150)	10.47 (266)	11.57 (294)	5.08 (129)
3 in.	80	5.91 (150)	10.67 (271)	11.77 (299)	5.51 (140)
4 in.	100	5.91 (150)	10.98 (279)	12.09 (307)	6.14 (156)

Nominal Pressure 580 psi (40 bar)

Transmitter Type ModMAG M1000 Specifications

Type	ModMAG M1000
Auxiliary Power	92...275V AC (50 / 60 Hz), 13VA optional 9...36V DC, 4 W
Analog Output	0/4...20 mA, $\leq 800 \text{ Ohm}$ / 0...10 mA Flow direction is displayed via separate status output
Digital Outputs	2 open collectors, passive 32V DC, 0...100 Hz 100 mA, 100...10,000 Hz 20 mA, optional active Pulse, status, error messages
Digital Inputs	Totalizers and preselectors reset Positive Zero Return
Frequency Output	10 kHz
Empty Pipe Detection Configuration	Separate electrode for empty pipe detection / field-tunable for optimal performance
Interfaces	3 external buttons
Measuring Range	RS232, RS422, RS485, ModBus RTU, Optional Ethernet ModBus TCP/IP, M-Bus or HART
Measuring Accuracy	0.10...39.37 ft/s (0.03...12 m/s)
Reproducibility	0.3% of reading $\pm 0.08 \text{ in./s}$ (2 mm/s)
Flow Direction	0.1%
Pulse Length	Uni-directional and bi-directional
Outputs	Configurable up to 2000 msec
Low Flow Cutoff	Short-circuit-proof and galvanically separated
Display	0...10%
Housing	Graphical LCD 64 x 128, backlight, actual flow rate, totalizers, status display
Mounting	Powder-coated aluminum die casting
Protective Class	Sensor or remote wall mount
Cable Insert	IP 67
Remote Signal Cable	Supply and signal cables 2 x M20
Coil Power	Up to 164 ft / 50 m
Altitude	Pulsed DC
Ambient Temperature	8202 ft (2500 m)
Humidity	-4...140° F (-20...60° C)
Approvals	90% R.H. max
Pollution Degree	NSF/ANSI/CAN 61 and 372 Listed: : Models with hard rubber liner 4 in. size and up; PTFE liner, all sizes
Installation Category	2
Units of Measure	II
	Gallons, ounces, MGD, liters, cubic meters, cubic feet, imperial gallon, barrel, hectoliter and acre-feet

ModMAG M1000 Transmitter in. (mm)

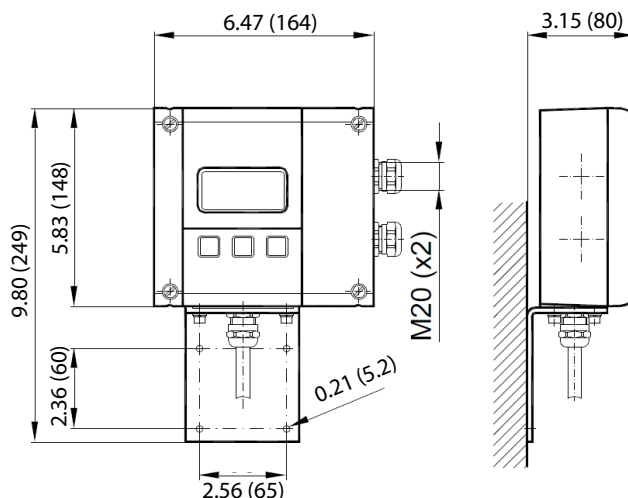

Error Limits

Measuring range	0.10...39.37 ft/s (0.03...12 m/s)
Pulse output	0.3% of reading ± 0.08 in./s (2 mm/s)
Analog output	Similar to pulse output ± 0.01 mA
Reproducibility	$\pm 0.1\%$

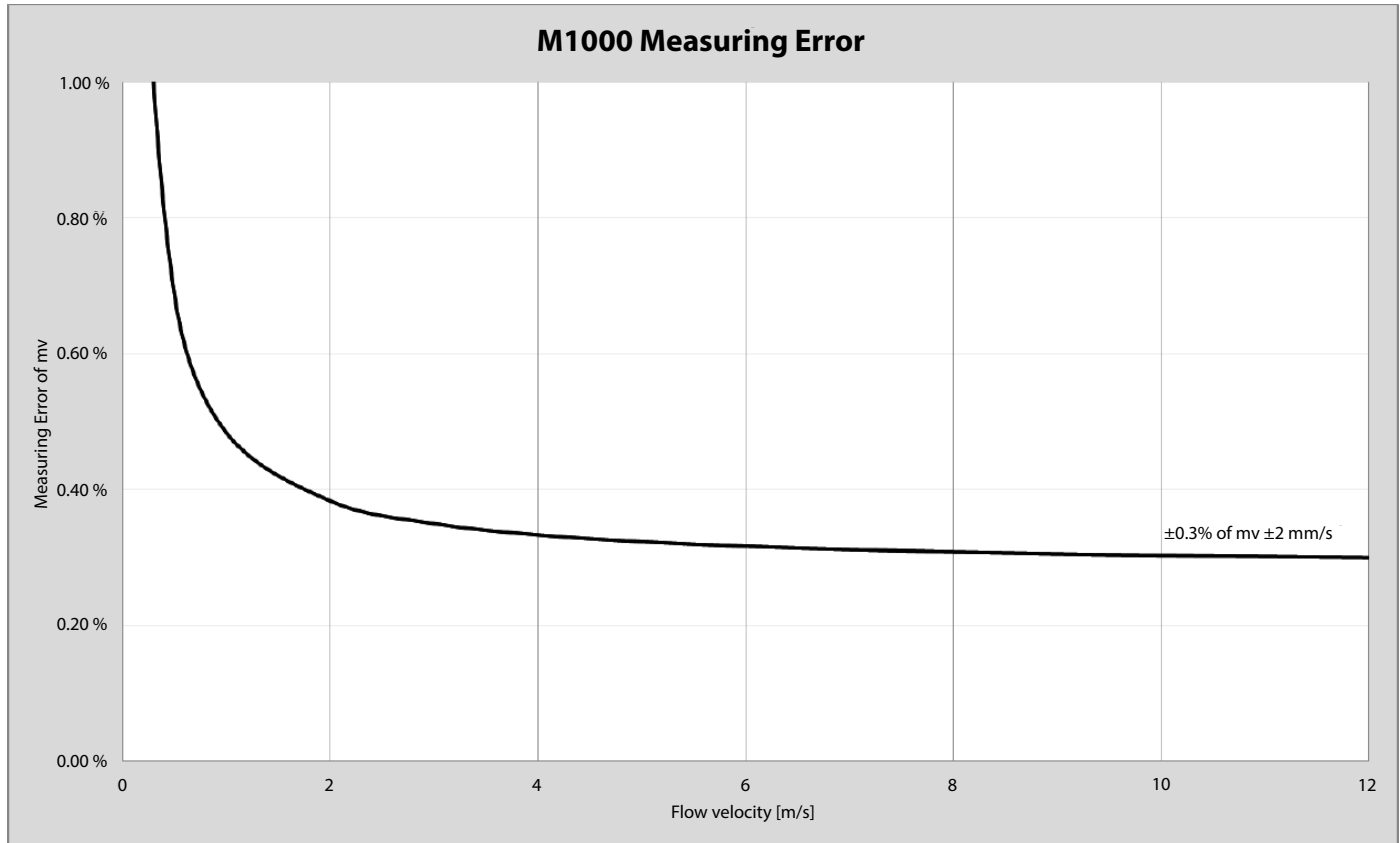

Reference conditions	
Ambient and fluid temperature	68° F (20° C)
Electric conductivity	>300 S/cm
Warm-up period	60 min
Mounting conditions	>3/8 in. (10 DN) inlet pipe
	>1/4 in. (5 DN) outlet pipe
	Sensor properly grounded and centered

SIZE SELECTION

Size		Flow Range	
Inches	DN	US	Metric
1/4	6	0.0134...5.4 GPM	0.051...20.4 l/min
3/10	8	0.0239...9.6 GPM	0.090...36.2 l/min
3/8	10	0.0373...14.9 GPM	0.141...57 l/min
1/2	15	0.084...33.6 GPM	0.318...127 l/min
3/4	20	0.149...60 GPM	0.57...226 l/min
1	25	0.233...93 GPM	0.88...353 l/min
1 1/4	32	0.382...153 GPM	1.45...579 l/min
1 1/2	40	0.60...239 GPM	2.26...905 l/min
2	50	0.93...373 GPM	3.53...1414 l/min
2 1/2	65	1.58...631 GPM	0.358...143 m ³ /h
3	80	2.39...956 GPM	0.54...217 m ³ /h
4	100	3.73...1494 GPM	0.85...339 m ³ /h
5	125	5.8...2334 GPM	1.33...530 m ³ /h
6	150	8.4...3361 GPM	1.91...763 m ³ /h
8	200	14.9...5975 GPM	3.39...1357 m ³ /h
10	250	23.3...9336 GPM	5.3...2121 m ³ /h
12	300	33.6...13,444 GPM	7.6...3054 m ³ /h
14	350	45.7...18,299 GPM	10.4...4156 m ³ /h
16	400	60...23,901 GPM	13.6...5429 m ³ /h
18	450	76...30,250 GPM	17.2...6870 m ³ /h
20	500	93...37,345 GPM	21.2...8482 m ³ /h

SPARE PARTS

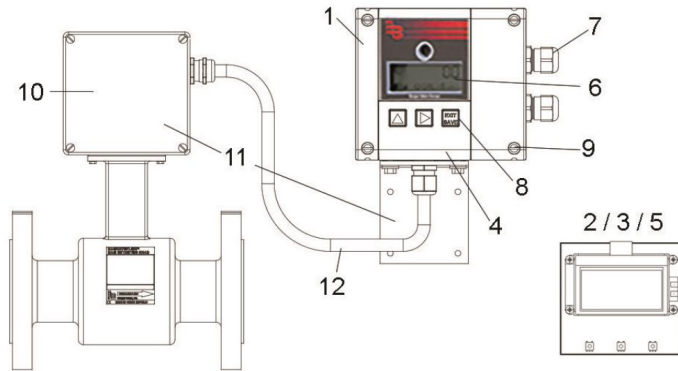

Item	Description	Part Number North America	International Info	Part Number International
1	Transmitter Assembly, Complete (110V AC)	67509-001	92...275V AC	592410
	Transmitter Assembly, Complete (24V DC)	67509-003	9...36V DC	592412
2	—	—	92...275V AC Board	384528
			9...36V DC Board	384529
3	Printed Circuit Board Assembly (110V AC)	67527-001	92...275V AC Board with Ethernet	384585
	Printed Circuit Board Assembly (24V DC)	67527-002	9...36V DC Board with Ethernet	384586
4	Cover (includes Cover, Lens, Buttons)	67885-005	Housing	384525
5	—	—	LCD Display (only available with board)	
6	—	—	Display Window	384522
7	Cable Gland	66796-001	—	382859
8	—	—	Buttons Kit Black	384707
9	Ball Screw	66312-001	—	384607
10	—	—	IP68 Kit for Remote Version	383077
11	Remote Mounting Kit, No Cable (includes Wall Mounting Bracket)	63384-046	—	384930
12	Remote Mounting Kit with Cable		International Options	
	5 ft	64574-007	5 m	384931
	10 ft	64574-008	10 m	384932
	15 ft	64574-002	15 m	384933
	30 ft	64574-003	20 m	384934
	50 ft	64574-004	25 m	384935
	75 ft	64574-010	30 m	384936
	100 ft	64574-005	35 m	384937
			40 m	384938
			45 m	384939
		50 m	384940	
—	Data Logging Kit (required for firmware updates)	67354-010	M-Bus Kit	592434
	Firmware Upgrade	67354-011	HART Kit	592436
			PC Programming Kit	592414

Control. Manage. Optimize.

ModMAG is a registered trademark of Badger Meter, Inc. Other trademarks appearing in this document are the property of their respective entities. Due to continuous research, product improvements and enhancements, Badger Meter reserves the right to change product or system specifications without notice, except to the extent an outstanding contractual obligation exists. © 2021 Badger Meter, Inc. All rights reserved.