





## CONTENTS

Safety Precautions and Instructions . . . . .	5
Basic Safety Precautions . . . . .	5
System Description . . . . .	6
Measuring Principle . . . . .	6
Unpacking and Inspection . . . . .	7
Rigging, Lifting and Moving Large Units . . . . .	7
Meter Location, Orientation and Applications . . . . .	9
Transmitter Mounting Configuration Options . . . . .	9
Temperature Ranges . . . . .	10
Protection Class . . . . .	10
Pipelines and Fluid Flow . . . . .	10
Meter Orientation . . . . .	11
Straight Pipe Requirements . . . . .	11
Pipe Reducer Requirements . . . . .	12
Chemical Injection Applications . . . . .	13
Partially-Filled Pipe Situations . . . . .	14
Meter Gaskets and Grounding . . . . .	15
Meter/Pipeline Connection Gaskets . . . . .	15
Meter Grounding and Potential Equalization . . . . .	15
Recommended Installation with Grounding Rings . . . . .	16
Plastic or Lined Pipelines . . . . .	17
Pipelines with Cathodic Protection . . . . .	17
Electrically Disturbed Environment . . . . .	17
Wiring . . . . .	18
Wiring Safety . . . . .	18
Opening the M2000 Meter Cover . . . . .	18
Power Connections . . . . .	18
Remote Mount Installation . . . . .	19
Signal Cable Specification . . . . .	21
Maximum Cable Length at Different Fluid Temperatures . . . . .	21
Configuring Input/Output (I/O) . . . . .	22
Analog Output Wiring Diagram . . . . .	23
Digital Output Wiring Diagrams . . . . .	24
Digital Input Wiring Diagram . . . . .	25

Communication Interfaces. . . . .	25
Programming the M2000 Meter . . . . .	27
Function Buttons. . . . .	27
Displays. . . . .	29
Security. . . . .	30
Setting Up the M2000 Meter with Quick Setup. . . . .	32
Menu Structure. . . . .	34
Using the Main Menu Programming Options. . . . .	36
Encoder Protocol Interface . . . . .	57
Store/Restore Feature. . . . .	59
Data Logging Feature. . . . .	59
Maintenance . . . . .	60
Cleaning the Flow Tube and Electrode . . . . .	60
Replacing the Circuit Board . . . . .	60
Replacing the Fuse. . . . .	60
Troubleshooting . . . . .	61
Specifications . . . . .	64
Transmitter Specifications . . . . .	64
Sensor Type II Specifications. . . . .	65
Sensor Type II Dimensions . . . . .	66
Sensor Type III Specifications . . . . .	68
Sensor Type III Dimensions . . . . .	68
Sensor with Sanitary Process Connections Specifications . . . . .	69
DIN 11851 Connection Dimensions . . . . .	69
Tri-Clamp Connection Dimensions . . . . .	70
Error Limits. . . . .	71
Size Selection . . . . .	72
Spare Parts . . . . .	73

## SAFETY PRECAUTIONS AND INSTRUCTIONS

Some procedures in this manual require special safety considerations. In such cases, the text is emphasized with the following symbols:

**⚠ DANGER** Indicates a hazardous situation, which, if not avoided, will result in death or serious personal injury.

**⚠ WARNING** Indicates a hazardous situation, which, if not avoided, could result in death or serious personal injury.

**⚠ CAUTION** Indicates a hazardous situation, which, if not avoided, could result in minor or moderate personal injury or damage to property.

### Basic Safety Precautions

Before installing or using this product, please read this instruction manual thoroughly.

Only qualified personnel should install and/or repair this product. If a fault appears, contact your distributor.

#### Installation

Do not place any unit on an unstable surface that may allow it to fall.

Never place the units above a radiator or heating unit.

Route all cabling away from potential hazards.

Isolate from the mains before removing any covers.

#### Protection Class

The device has protection class IP 67 and needs to be protected against water, oils, etc.

#### Setup and Operation

Adjust only those controls that are covered by the operating instructions. Improper adjustment of other controls may result in damage, incorrect operation or loss of data.

#### RoHs

Our products are RoHs compliant.

## SYSTEM DESCRIPTION

The Badger Meter model M2000 electromagnetic flow meter is intended for fluid metering in most industries including water, wastewater, food and beverage, pharmaceutical and chemical. The meter is intended for the metering of all fluids with electric conductivity of at least  $5 \mu\text{S}/\text{cm}$  ( $20 \mu\text{S}/\text{cm}$  for demineralized water). The meter has a high degree of accuracy, and measuring results are independent of density, temperature and pressure.

The basic components of an electromagnetic flow meter are:

- The **sensor**, which includes the flow tube, isolating liner and measuring electrodes.
- The **transmitter**, which is the electronic device responsible for the signal processing, flow calculation, display and output signals.

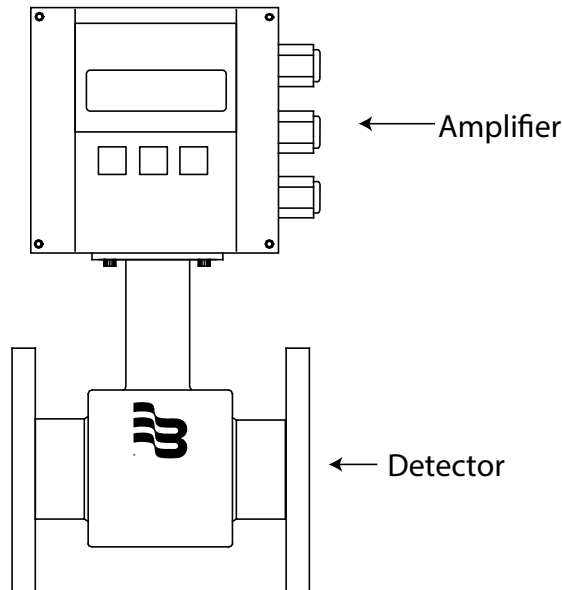

Figure 1: Transmitter and sensor

The construction materials of the wetted parts (liner and electrodes) should be appropriate for the intended type of service. Review all the compatibilities consistent with the specifications.

Each meter is factory tested and calibrated. A calibration certificate is included with each meter.

### Measuring Principle

In accordance with Faraday's induction principle, electric voltage is induced in a conductor moving through a magnetic field. In the case of electromagnetic flow measurement, the moving conductor is the flowing fluid. Two opposite measuring electrodes conduct the induced voltage, which is proportional to flow velocity, to the transmitter. Flow volume is calculated based on pipe diameter.

## UNPACKING AND INSPECTION

Follow these guidelines when unpacking the equipment.

- If a shipping container shows any sign of damage, have the shipper present when you unpack the meter.
- Follow all unpacking, lifting and moving instructions associated with the shipping container.
- Open the container and remove all packing materials. Store the shipping container and packing materials if the unit needs to be shipped for service.
- Verify that the shipment matches the packing list and your order form.
- Inspect the meter for any signs of shipping damage, scratches, or loose or broken parts.

**NOTE:** If the unit was damaged in transit, it is your responsibility to request an inspection report from the carrier within 48 hours. You must then file a claim with the carrier and contact Badger Meter for appropriate repairs or replacement.

- All sensors with polytetrafluoroethylene (PTFE) liners are shipped with a liner protector on each end to maintain proper form of the PTFE material during shipping and storage.
- Do not remove the liner protectors until you are ready to install.

**NOTE:** Storage: If the meter is to be stored, place it in its original container in a dry, sheltered location. Storage temperature ranges are:  $-40 \dots 160^{\circ}\text{F}$  ( $-40 \dots 71^{\circ}\text{C}$ ).

### Rigging, Lifting and Moving Large Units

#### ⚠ CAUTION

**WHEN RIGGING, LIFTING OR MOVING LARGE UNITS, FOLLOW THESE GUIDELINES:**

- DO NOT lift or move a meter by its transmitter, junction box, sensor neck or cables.
- Use a crane rigged with soft straps to lift and move meters with flow tubes that are 2...8 inches (50...200 mm). Place the straps around the sensor body, between the flanges, on each side of the sensor.
- Use the lifting lugs when lifting meter flow tubes that are 10 inches (250 mm) in diameter or larger.

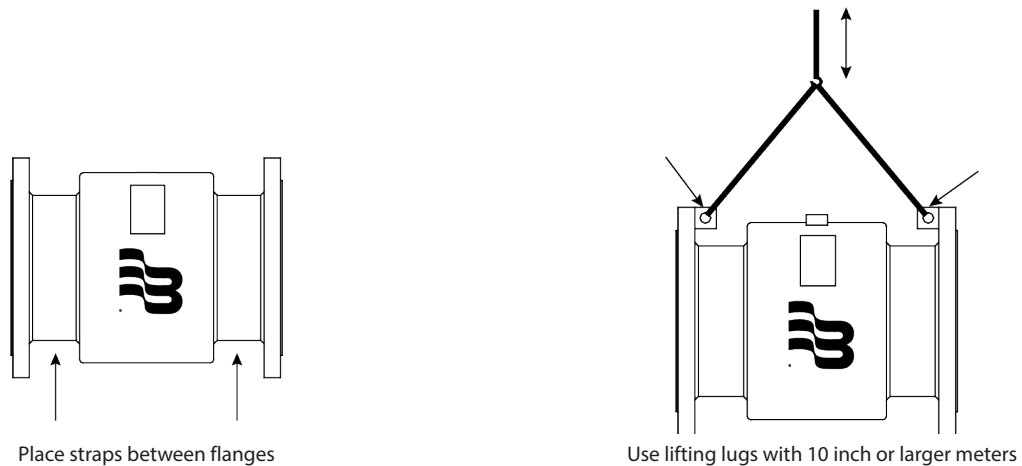

Figure 2: Rigging large units

- Use the sling-rigged method to lift large sensors into a vertical position while they are still crated. Use this method to position large sensors vertically into pipelines.

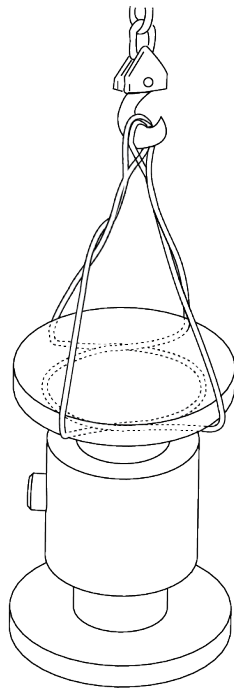
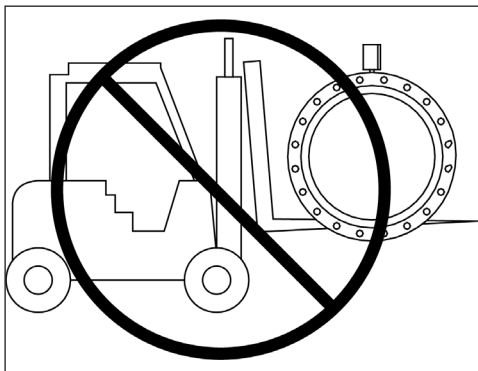
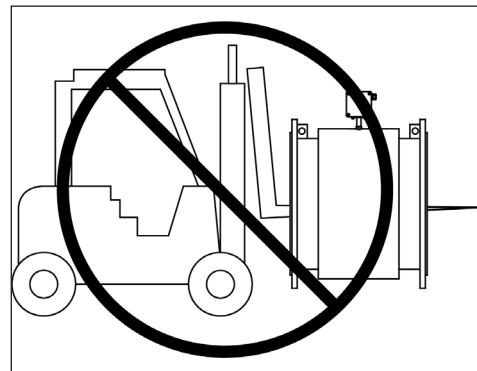

Figure 3: Sling-Rigged lifting methods

- Do not lift a sensor with a forklift by positioning the sensor body on the forks, with the flanges extending beyond the lift. This could dent the housing or damage the internal coil assemblies.
- Never place forklift forks, rigging chains, straps, slings, hooks or other lifting devices inside or through the sensor's flow tube to hoist the unit. This could damage the isolating liner.



Do not lift sensor with forklift



Do not lift or rig lifting devices through sensor

Figure 4: Lifting and rigging cautions



## METER LOCATION, ORIENTATION AND APPLICATIONS

Gasket and grounding requirements must be considered when determining the meter location, orientation and application. See *"Meter Gaskets and Grounding"* on page 15. There are two transmitter mounting options: a meter mount option and a remote mount option.

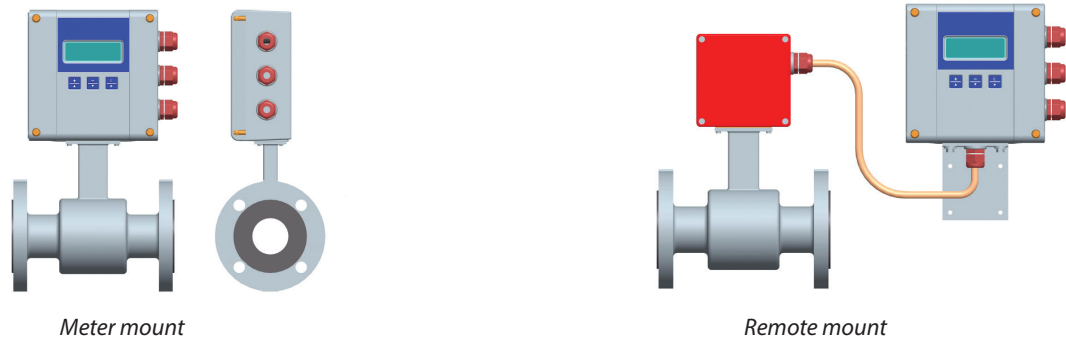

Figure 5: Transmitter mounting options

### Transmitter Mounting Configuration Options

There are two configuration options for mounting the transmitter and many options to accommodate a variety of meter-placement and environmental conditions.

#### Meter Mount Configuration

The meter mount configuration has the transmitter mounted directly on the sensor. This compact, self-contained configuration minimizes installation wiring.

#### Remote Mount Configuration

The remote mount configuration places the transmitter at a location away from the fluid flow and sensor. This is necessary in situations where process fluid temperature or the environment exceeds transmitter ratings.

The sensor and transmitter are connected by wires, run through conduit, between junction boxes on the sensor and the transmitter. The distance between the sensor junction box and transmitter junction box can be up to 500 feet (150 meters). A remote mounting bracket is supplied.

Use the remote version in the following cases:

- Sensor protection class IP 68
- Fluid temperature > 212° F (100° C)
- Strong vibrations

#### Remote Transmitter Outdoor Location

The transmitter can be installed and operated outdoors. However, it must be protected from the elements, as follows:

- The ambient environment/temperature rating for the unit is  $-4 \dots 140^{\circ} \text{F}$  ( $-20 \dots 60^{\circ} \text{C}$ ).
- If an indoor location is within 500 feet (150 meters) of the sensor, consider increasing the cable length and mounting the transmitter indoors.
- At minimum, fabricate a roof or shield over and/or around the transmitter to protect the LCD screen from direct sunlight.
- Do not install the signal cable close to power cables, electric machines or similar.
- Fasten signal cables. Due to capacity changes, cable movements may result in incorrect measurements.

#### Submersible Option

If you are installing the meter in a vault, order the remote transmitter option. Do not install the transmitter inside a vault. We also recommend ordering the remote meter package with the submersible option (NEMA 6P / IP68). This eliminates any potential problems resulting from humidity or temporary flooding in the vault.

The National Electronics Manufacturer's Association (NEMA) 6P enclosures are constructed for indoor or outdoor use. The 6P enclosures provide protection against access to hazardous parts. They also provide a degree of protection against ingress of solid foreign objects and water (hose directed water and the entry of water during prolonged submersion at a limited depth) which provide an additional level of protection against corrosion and that are not damaged by the external formation of ice on the enclosure.

## Temperature Ranges

### ⚠ CAUTION

**TO PREVENT DAMAGE TO THE METER, STRICTLY OBSERVE THE TRANSMITTER'S AND SENSOR'S MAXIMUM TEMPERATURE RANGES.**

- To prevent damage to the meter, strictly observe the transmitter and sensor temperature ranges.
- In regions with extremely high ambient temperatures, protect the sensor from extreme temperatures.
- In cases where fluid temperature exceeds 212° F (100° C), use the remote mount version.

Transmitter	Ambient temperature		-4...140° F (-20...60° C)
Sensor	Fluid temperature	PTFE/PFA	-40...302° F (-40...150° C)
		Hard rubber	32...176° F (0...80° C)
		Soft rubber	32...176° F (0...80° C)

## Protection Class

To fulfill requirements of the protection class, follow these guidelines:

### ⚠ CAUTION

- Make sure body seals are undamaged and in proper condition.
- Firmly screw in all the body screws.
- Outer diameters of the wiring cables must correspond to cable inlets (for M20 Ø 5...10 mm). In cases where cable inlet is not used, put in a dummy plug.
- Tighten cable inlets.
- If possible, lead cable away downwards to prevent humidity from entering cable inlet.

The standard option is protection class IP 67. If you require a higher protection class, use the remote mount version. NEMA 6P / IP 68 is an option for the sensor with the remote mount version.

## Pipelines and Fluid Flow

Take the following precautions during installation:

- Do not install the meter on pipes with extreme vibrations. If pipes are vibrating, secure the piping with appropriate pipe supports in front of and behind the meter. If vibrations cannot be restrained, use the remote mount option.
- Do not install the sensor close to pipeline valves, fittings or impediments that can cause flow disturbances.
- For sensors with PTFE liners, do not install the sensor on suction sides of pumps.
- Do not install the sensor on outlet sides of piston or diaphragm pumps. Pulsating flow can affect meter performance.
- Avoid installing the sensor near equipment that produces electrical interference such as electric motors, transformers, variable frequency or power cables.
- Make sure both ends of the signal cables are securely fastened.
- Place power cables and signal cables in separate conduits.
- Place the meter where there is enough access for installation and maintenance tasks.
- Install the meter with the forward flow label on the meter body matching the pipeline flow.

- For sensors with PTFE liner, only remove the protective cap on the flange or on the threaded pipes of milk pipe screws per DIN 11851 shortly before installation.

## Meter Orientation

Mag meters can operate accurately in any pipeline orientation and can measure volumetric flow in forward and reverse directions as long as the pipe is completely full.

**NOTE:** A “Forward Flow” direction arrow is printed on the sensor label.

### Vertical Placement

Mag meters perform best when placed vertically, with liquid flowing upward and meter electrodes in a closed, full pipe.

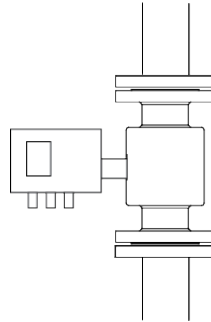

Figure 6: Vertical placement

Vertical placement allows the pipe to remain completely full, even in low flow, low pressure applications, and it prevents solids build-up, sediment deposit and accumulation on the liner and electrodes.

**NOTE:** Carefully observe the “Forward Flow” label on the meter body and install the meter accordingly. When installed vertically, rotate transmitter so that the cable glands are facing down.

### Horizontal Placement

When installing the meter on a horizontal pipe, mount the sensor to the pipe with the flow-measuring electrode axis in a horizontal plane (three and nine o’clock). This placement helps prevent solids build-up, sediment deposit and accumulation on the electrodes.

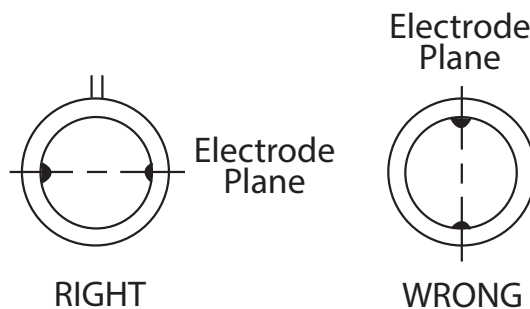

Figure 7: Horizontal placement

### Empty Pipe Detection

M2000 meters are equipped with an empty pipe detection feature. If an electrode mounted in the pipe is not covered by fluid for five seconds, the meter displays an empty pipe detection condition. The meter sends out an error message and stops measuring flow. When the electrode is again covered with fluid, the error message disappears and the meter resumes measuring.

### Straight Pipe Requirements

Run sufficient straight-pipe at the sensor inlet and outlet for optimum meter accuracy and performance. An equivalent of 3...7 diameters of straight pipe is required on the inlet (upstream) side to provide a stable flow profile. Two(2) diameters are required on the outlet (downstream) side.

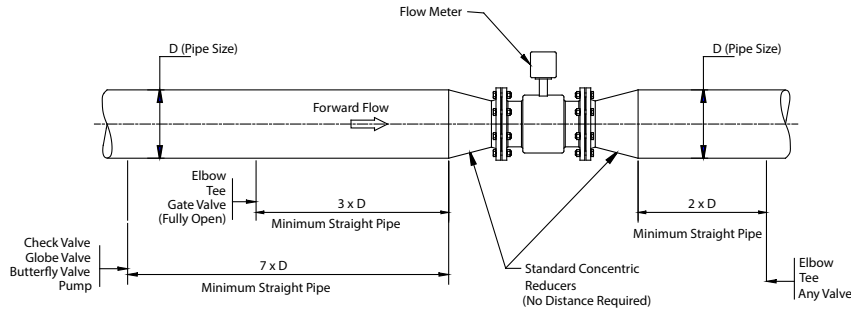

Figure 8: Minimum straight pipe requirements

## Pipe Reducer Requirements

With pipe reducers, a smaller meter can be mounted in larger pipelines. This arrangement may increase low-flow accuracy.

There are no special requirements for standard, concentric, pipe reducers.

Custom fabricated pipe reducers must have a maximum slope angle of 8 degrees on each side to minimize flow disturbances and excessive loss of head. If this is not possible, install the custom pipe reducers as if they were fittings and install the required amount of straight pipe.

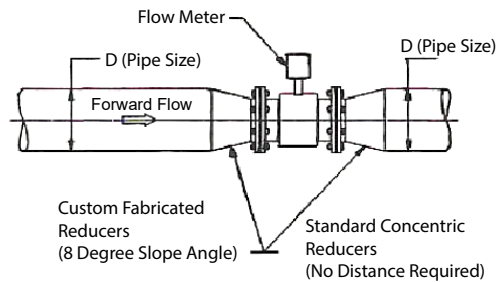

Figure 9: Pipe reducer requirements

Use this nomogram to determine the occurring pressure drop (only applicable to liquids with similar viscosity like water).

$D$  = Pipeline diameter

$d$  = Sensor diameter

1. Calculate the diameter ratio  $d/D$ .
2. Read the pressure loss depending on  $d/D$  ratio and flow velocity.

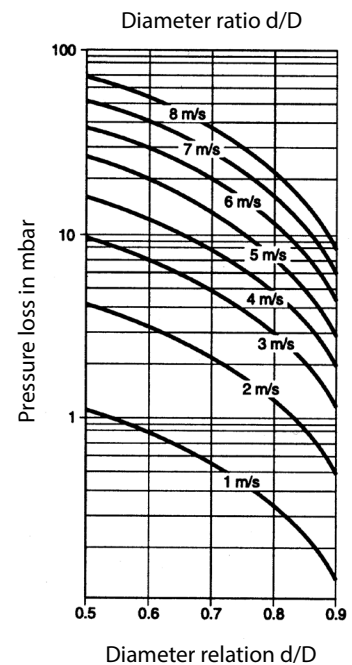

## Chemical Injection Applications

For water line applications with a chemical injection point, install the meter upstream of the injection point. This eliminates any meter performance issues.

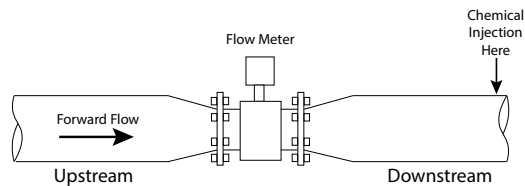

Figure 10: Chemical injection point downstream of meter

If a meter must be installed downstream of a chemical injection connection, the distance between the flange and the injection point should be 50...100 feet (15...30 meters). The distance must be long enough to allow the water/chemical solution to reach the meter in a complete, homogeneous mixture. If the injection point is too close, the meter senses the two conductivities for each liquid. This likely results in inaccurate measurements. The injection method—spaced bursts, continuous stream of drips or liquid or gas—can also affect downstream readings by the meter.

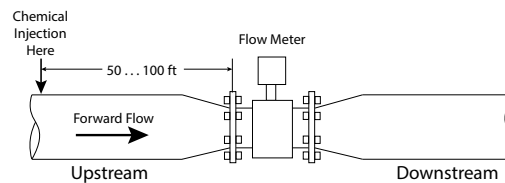

Figure 11: Chemical injection point upstream of meter

Sometimes, due to circumstances, it is difficult to specify the exact downstream placement distances. Contact Badger Meter Technical Support to review your application, if necessary.

## Partially-Filled Pipe Situations

In some locations, the process pipe may be momentarily only partially filled. Examples include: lack of back pressure, insufficient line pressure and gravity flow applications.

To eliminate these situations:

- Do not install the meter at the highest point of the pipeline.
- Do not install the meter in a vertical, downward flow section of pipe.
- Always position the ON/OFF valves on the downstream side of the meter.

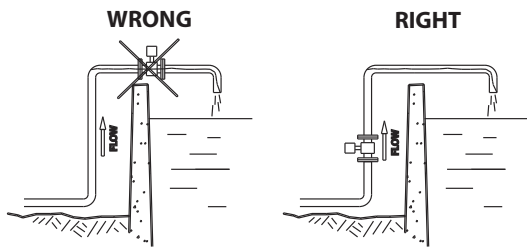

Figure 12: Incorrect meter placement

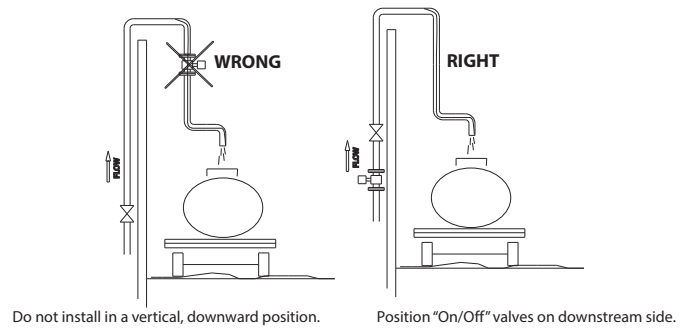

Figure 13: Position valves on downstream side

To minimize the possibility of partially-full pipe flows in horizontal, gravity or low pressure applications, create a pipe arrangement that allows the sensor to remain full of liquid at all times.

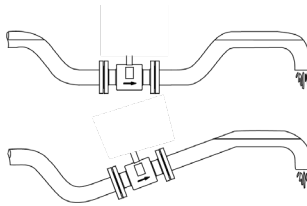

Figure 14: Pipe positioned to keep water in sensor

## METER GASKETS AND GROUNDING

Gaskets and grounding are required for proper meter installation.

### IMPORTANT

If you received grounding rings with your meter, install them. Electromagnetic meters require a good ground for proper operation. Grounding rings also help protect the edge of the liner from debris that may flow from the pipe.

### Meter/Pipeline Connection Gaskets

#### IMPORTANT

It is essential that the transmitter's input ground (zero voltage reference) be electrically connected to the liquid media and to a good, solid earth ground reference.

You must install gaskets (not provided) between the sensor's isolating liner, grounding rings and the pipeline flange to provide a proper and secure hydraulic seal. Use gaskets that are compatible with the fluid. Center each gasket on the flange to avoid flow restrictions or turbulence in the line.

During installation, do not use graphite or any electrically conductive sealing compound to hold the gaskets. This could compromise the accuracy of the measuring signal.

If you are using a grounding ring in the sensor/pipeline connection, place the ring between two gaskets. See "[Recommended Installation with Grounding Rings](#)" on page 16 for more instructions.

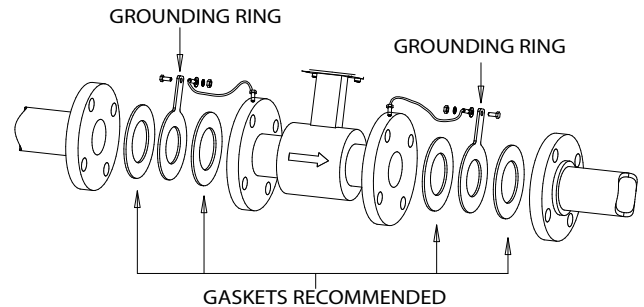

Figure 15: Meter/pipeline connection gaskets and grounding rings

### Meter Grounding and Potential Equalization

In order to obtain an accurate measurement, sensor and fluid need to be on the same electric potential.

Process pipeline material can be either electrically conductive (metal) or not electrically conductive (made of or lined with PVC, fiberglass or concrete).

If flange or intermediate flange versions with additional grounding electrode are used, grounding is provided by the connected pipeline.

#### ⚠ CAUTION

**IN CASE OF A TYPE WITH FLANGE, USE A CONNECTION CABLE (MINIMUM 4 MM<sup>2</sup>) BETWEEN GROUNDING SCREW ON THE METER FLANGE TO THE COUNTERFLANGE IN ADDITION TO THE FIXING SCREWS. VERIFY THAT A PERFECT ELECTRIC CONNECTION IS PROVIDED.**

#### ⚠ CAUTION

**COLOR OR CORROSION ON THE COUNTERFLANGE MAY HAVE A NEGATIVE EFFECT ON THE ELECTRIC CONNECTION.**

#### ⚠ CAUTION

**IN CASE OF TYPES WITH INTERMEDIATE FLANGES, THE ELECTRIC CONNECTION TO THE SENSOR IS DONE VIA TWO 1/4 AMP PLUGS INSTALLED ON SENSOR'S NECK.**

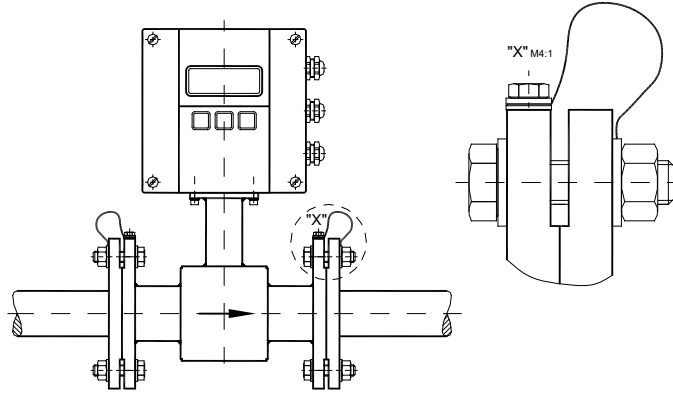

Figure 16: Grounding electrode

## Recommended Installation with Grounding Rings

### IMPORTANT

Badger Meter recommends the installation of a pair of grounding rings between the mating flanges at both ends of the meter. See [Figure 15 on page 15](#).

Connect the grounding straps to both of the grounding rings and to a good, solid earth ground. Grounding rings are available in stainless steel. If your fluid is too aggressive for stainless steel, order a meter with the optional grounding electrode in a material compatible with the fluid.



## Plastic or Lined Pipelines

If non-conductive pipelines or pipelines lined with non-conductive material are used, install an additional grounding electrode or grounding rings between the flanges. Grounding rings are installed like gaskets between the flanges and are connected with a grounding cable to the meter (See [Figure 15 on page 15](#)).

### ⚠ CAUTION

**WHEN GROUNDING RINGS ARE USED, MAKE SURE THE MATERIAL IS RESISTANT TO CORROSION. IF AGGRESSIVE FLUIDS ARE MEASURED, USE GROUNDING ELECTRODES.**

## Pipelines with Cathodic Protection

For pipelines with cathodic protection, install the meter potential-free. No electric connection from the meter to the pipeline system may exist and power supply is to be provided via isolating transformer.

### ⚠ CAUTION

**USE GROUNDING ELECTRODES (GROUNDING RINGS ALSO NEED TO BE INSTALLED ISOLATED FROM THE PIPELINE SYSTEM).**

Observe national rules regarding potential-free installation

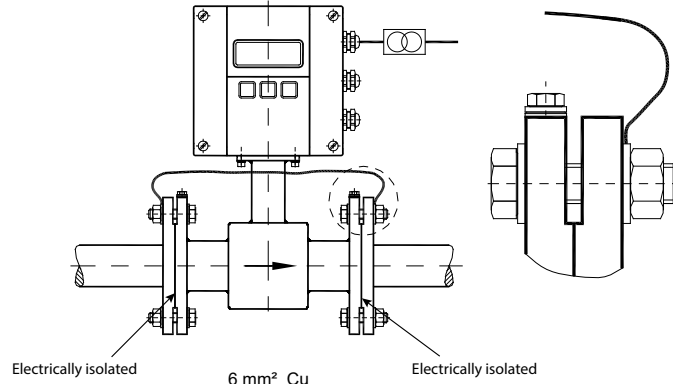

Figure 17: Grounding for pipeline with cathodic protection

## Electrically Disturbed Environment

If the pipe material is in an electrically disturbed environment or if metallic pipelines that are not grounded are used, ground the meter as shown in [Figure 18](#) to make sure that measurement is not influenced.

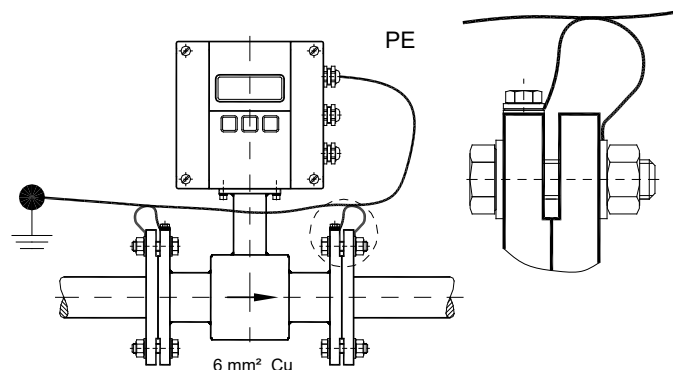

Figure 18: Grounding for electrically disturbed environment

## WIRING

### Wiring Safety

#### **⚠ WARNING**

**AT INSTALLATION, BE SURE TO COMPLY WITH THE FOLLOWING REQUIREMENTS:**

- **Disconnect power to the unit before attempting any connection or service to the unit.**
- **Do not bundle or route signal lines with power lines.**
- **Keep all lines as short as possible.**
- **Use twisted pair shielded wire for all output wiring.**
- **Observe all applicable, local electrical codes.**
- **Use only the type of power source suitable for electronic equipment. If in doubt, contact your distributor. Make sure that any power cables are of a sufficiently high current rating.**
- **All units must be grounded to eliminate risk of electric shock.**
- **Failure to properly ground a unit may cause damage to that unit or data stored within it.**

### Opening the M2000 Meter Cover

The M2000 transmitter's design lets you open the cover without completely removing it.

#### **⚠ WARNING**

**COVER IS ATTACHED WITH DISPLAY RIBBON CABLE.**

**TO OPEN THE COVER YOU NEED A BLADE SCREWDRIVER.**

Follow these steps:

1. Disconnect power to the unit.
2. Completely remove the two screws from either the left or the right side of the transmitter.
3. Loosen each of the remaining screws so that the round head of the screw clears the top edge of the cover.
4. Lift and pivot the cover into the open position.



Figure 19: Open cover

### Power Connections

- For the 3 × M20 cable inlets only use flexible electric cables.
- Use separate cable inlets for auxiliary power, signal and input/output cables.

## External Disconnect

### **⚠ CAUTION**

**INSTALL AN EXTERNAL DISCONNECT SWITCH OR CIRCUIT BREAKER THAT MEETS LOCAL STANDARDS.**  
**POSITION THE M2000 METER IN AN ACCESSIBLE LOCATION.**  
**POSITION AND IDENTIFY THE DISCONNECT DEVICE SO AS TO PROVIDE SAFE AND EASY OPERATION.**  
**LABEL THE DISCONNECT DEVICE AS BEING FOR THE MAG METER.**

## AC Power Wiring

For the AC power connections, use a three-wire sheathed connection cable suitable for the rating of this device. For signal output use 18...22 gauge (0.25...0.75 mm<sup>2</sup>) shielded wire. Overall cable diameter between 0.20...0.39 inch (5...10 mm).

### **⚠ CAUTION**

**TO PREVENT ACCIDENTS, CONNECT MAIN POWER ONLY AFTER ALL OTHER WIRING HAS BEEN COMPLETED.**

The transmitter is a microprocessor device. It is important that the power supply be as “clean” as possible. Avoid using power lines that feed heavy loads: pumps, motors, etc. If dedicated lines are not available, a filtering or isolation system may be required.

Power wiring is the same for meter mount and remote mount transmitters.

## Auxiliary Power

### **⚠ WARNING**

**DO NOT CONNECT METER UNDER IMPRESSED MAINS VOLTAGE.**  
**TAKE NATIONAL APPLICABLE RULES INTO ACCOUNT.**  
**OBSERVE TYPE PLATE (MAINS VOLTAGE AND FREQUENCY).**

1. Slightly loosen both of the left cover screws and loosen the two right cover screws completely. Open cover to the left side.
2. Push auxiliary power cable through the upper cable inlet.
3. Connection as shown in [Figure 20 on page 20](#).
4. Close connection cover firmly.

## Remote Mount Installation

Follow these instructions to install the M2000 remote transmitter.

### Mount Bracket to Transmitter

1. Align bracket-mounting holes with transmitter mounting holes.
2. Attach bracket to transmitter with supplied screws. Torque screws to 80 inch pounds.

### Wiring Configuration

Wiring between the sensor and the M2000 transmitter comes complete from the factory. If your installation requires the use of conduit, we recommend that you follow these steps when wiring the sensor to the transmitter.

1. Remove the junction box lid. Carefully remove the wires connected to the terminal blocks that run to the M2000 transmitter. See [Figure 20 on page 20](#) for a reference of wire color to terminal connection.
2. Run cable through the conduit from the transmitter location while retaining the wiring of the cable to the transmitter, as supplied.
3. Complete conduit assembly on both ends and rewire the cable into the junction box as it was previously wired.

**Wiring for Remote Configuration**



**CONNECT OR SEPARATE SIGNAL CONNECTION CABLE ONLY WHEN THE UNIT HAS BEEN SWITCHED OFF.**

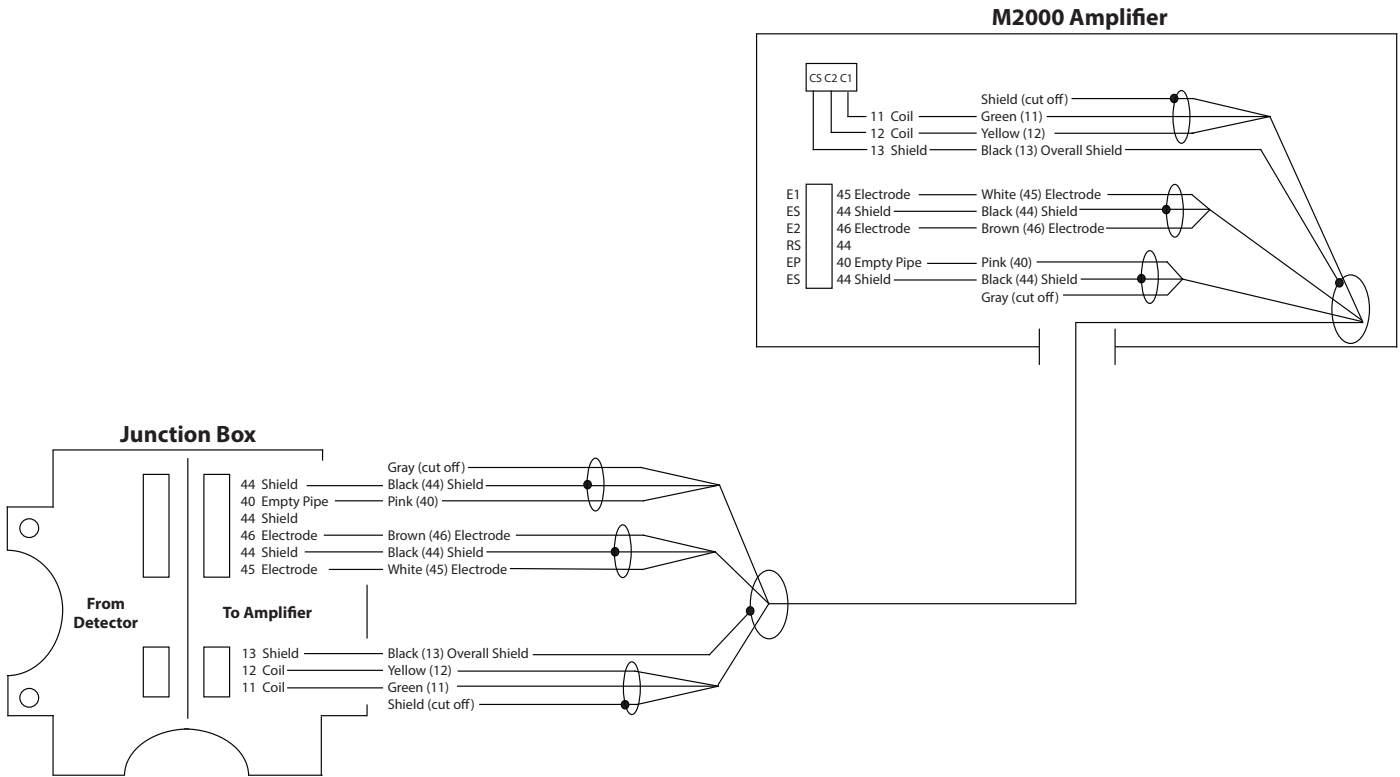

Figure 20: Wiring for remote configuration

Remote style M2000 transmitter models can be ordered with standard cables measuring 15, 30, 50, 100 and 150 feet. In addition, cables up to 500 feet are available.

From Junction Box			To M2000 Transmitter
Connection No.	Description	Wire Color	Connection Label
11	Coil	Green	C1
12	Coil	Yellow	C2
13	Main Shield	Black (Red Ferrule)	CS
45	Electrode	White	E1
44*	Electrode Shield	Black	ES
46	Electrode	Brown	E2
40	Empty Pipe	Pink	EP
44*	Empty Pipe Shield	Black	ES

\*Connections with the No. 44 are lying on the same potential.

**Empty Pipe Detection Considerations**

Take into account the following cable length and conductivity requirements if you are using empty pipe detection.

Cable Length (Feet)	Minimum Conductivity Required (µS/cm)
0*	5
100	20
500	100

\* Meter Mount

## Signal Cable Specification

**NOTE:** Only use signal cables delivered by Badger Meter or corresponding cable in accordance with the following specification.

Take maximum signal cable length between sensor and transmitter into account (keep distance as low as possible).

Distance	With electrode idle	Loop resistance
0...75 m	$3 \times (2 \times 0.25 \text{ mm}^2)$	$\leq 160 \text{ } \Omega/\text{km}$
>75...150 m	$3 \times (2 \times 0.50 \text{ mm}^2)$	$\leq 80 \text{ } \Omega/\text{km}$

PVC cable with pair and total shield  
 Capacity: wire/wire < 120 nF/km, wire/shield < 160 nF/km  
 Temperature range: -22...158° F (-30...70° C)

## Maximum Cable Length at Different Fluid Temperatures

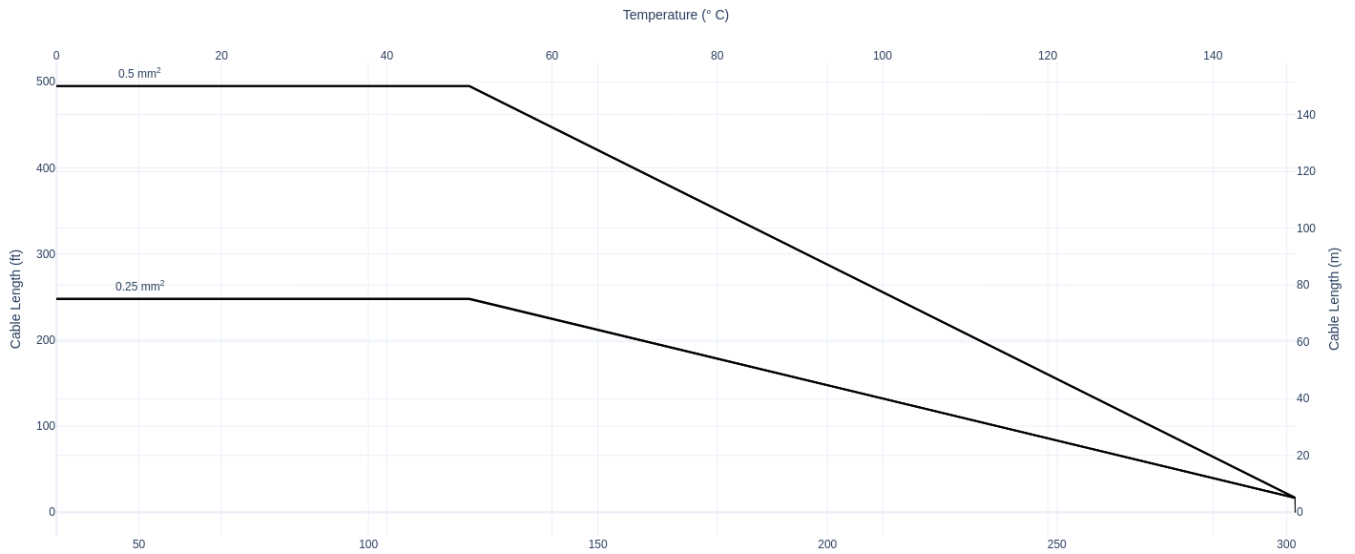

## CONFIGURING INPUT/OUTPUT (I/O)

This section describes wiring the following M2000 meter inputs/outputs:

- Analog output
- Digital input
- Digital outputs
- Communication

Once the sensor and the transmitter have been wired, wire any inputs and outputs to the M2000 transmitter.

Do not connect the main power connection until you have made all other wiring connections. Follow all of the safety precautions and local code to prevent electrical shock and damage to the electronic components.

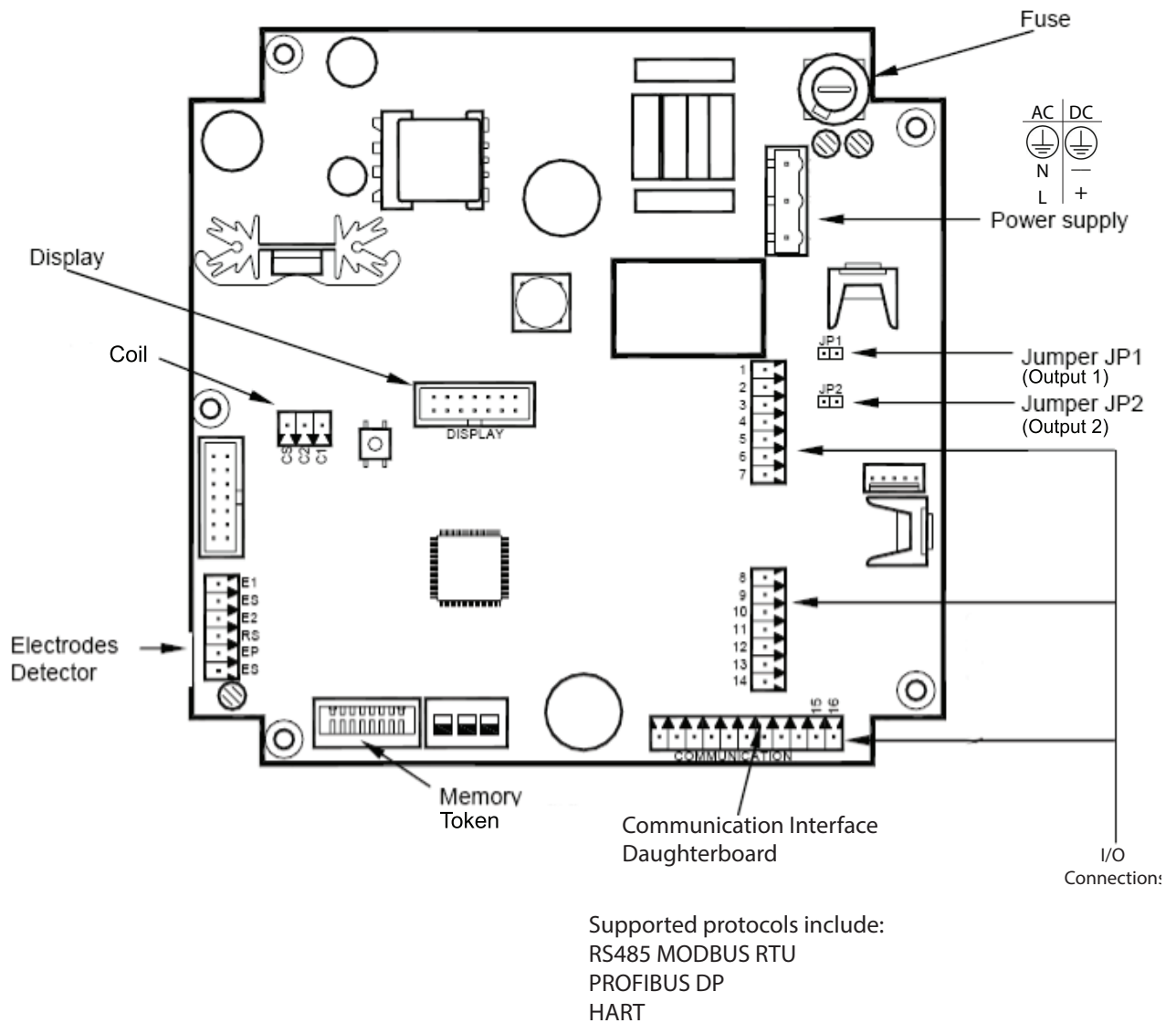

Figure 21: Configuring input/output

Input/Output	Description	Terminal
Analog Output	0...20 mA Resistive Load < 800 ohms 4...20 mA Resistive Load < 800 ohms 0...10 mA Resistive Load < 800 ohms 2...10 mA Resistive Load < 800 ohms	16 (+) 15 (-)
Digital Output 1	Passive maximum 30V DC, 100 mA Active 24V DC, 50 mA (set Jumper JP1) Maximum Frequency 10 kHz	1 (+) and 2 (-)
Digital Output 2	Passive maximum 30V DC, 100 mA Active 24V DC, 50 mA (set Jumper JP2) Maximum Frequency 10 kHz	3 (+) and 4 (-)
Digital Output 3	Passive Max 30V DC, 100 mA, 10 kHz Solid State Relay 48V AC, 500 mA, 1 kHz * Software configurable	10 (+) and 9 (-) 10 (+) and 11 (-)
Digital Output 4	Passive Max 30V DC, 100 mA, 10 kHz Solid State Relay 48V AC, 500 mA, 1 kHz * Software configurable	13 (+) and 12 (-) 13 (+) and 14 (-)
Digital Input	5...30V DC	8 (+) and 9 (-)
RS 232	RS232, configurable, MODBUS RTU, Remote Menu, or Primo 3.1 Emulation	7 GND 6 Rx 5 Tx
Communication	Optional communications ports like HART, Profibus DP, ModBus® RS 485, M-Bus	Communication

## Analog Output Wiring Diagram

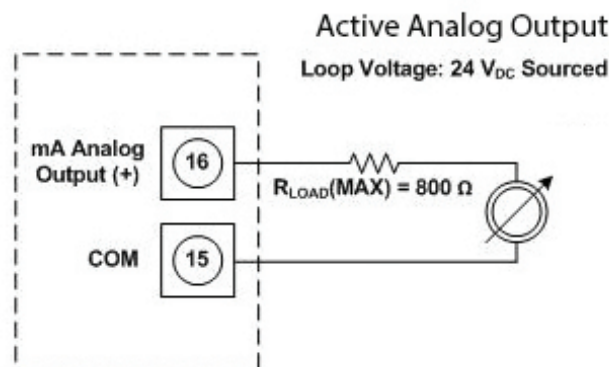

Figure 22: Analog output wiring diagram

## Digital Output Wiring Diagrams

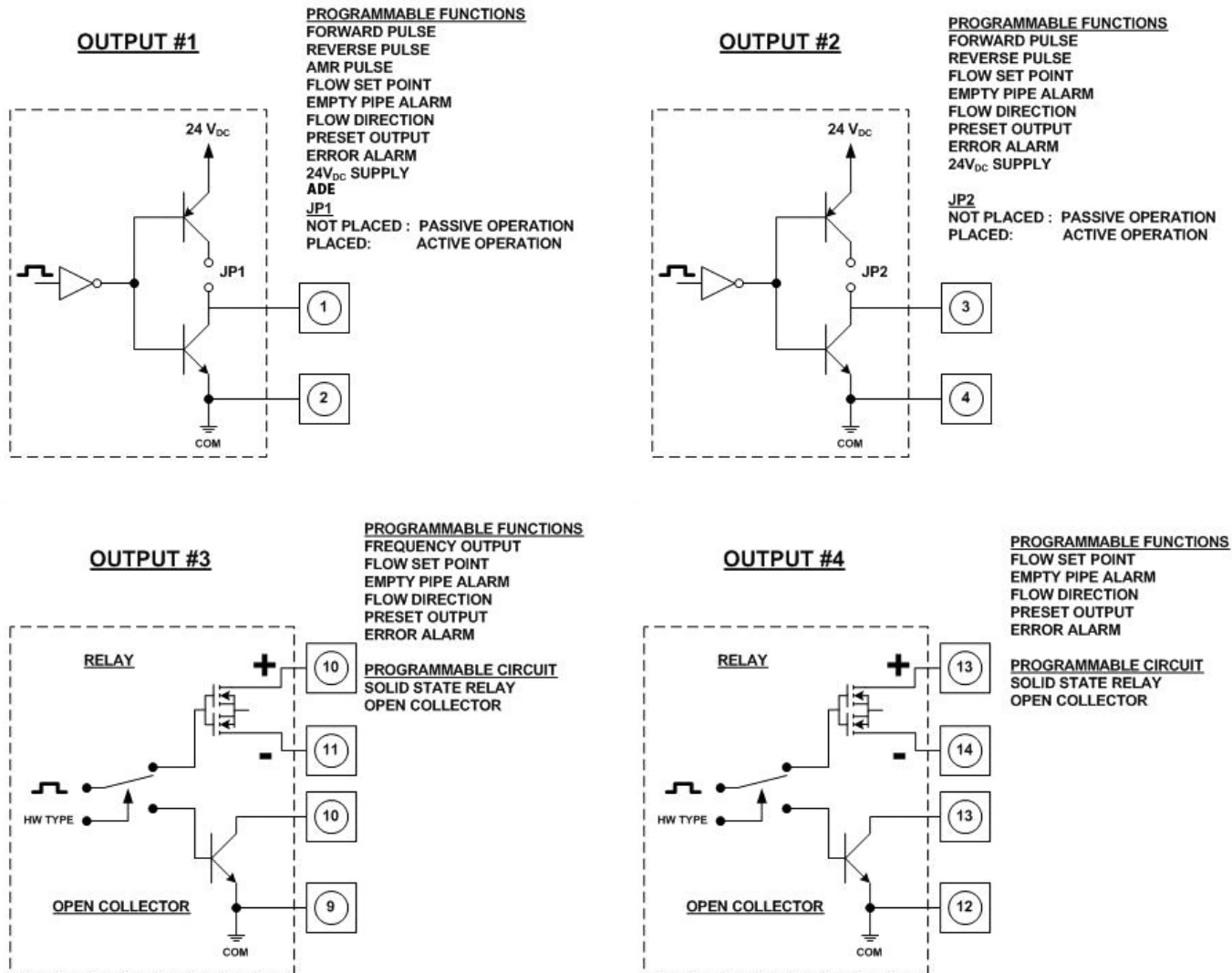

Figure 23: Digital output wiring diagrams



## Digital Input Wiring Diagram

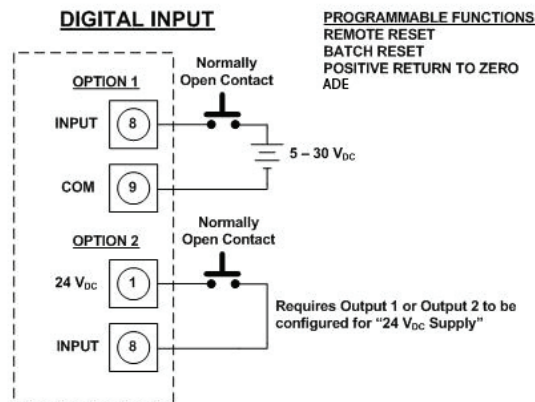

Figure 24: Digital input wiring diagram

**NOTE:** Option 2 can be connected to terminals 1 and 8 or optionally to terminals 3 and 8. Depending on which output is used, set this output to 24V supply.

## Communication Interfaces

M2000 offers following communication interfaces:

- Modbus® RTU RS485
- M-Bus
- HART
- Profibus DP

The additional interface board is already plugged in by the manufacturer or can be ordered and easily plugged in afterwards. The interface board is plugged in to the 11 pin connector at the lower right of the main board.

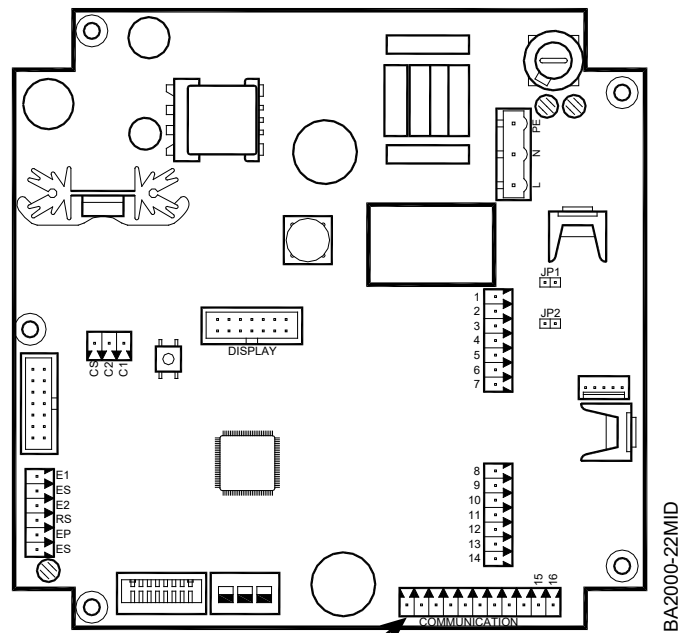

Communication Interface

Figure 25: Communication interface

The internal communications between the main board and the interface board are done via Port B. For M-Bus, HART and Profibus DP, the following adjustments are done in the menu *Communication->Port B*

Port B:           Port Adr. 001  
                  Baudrate 38400  
                  Data bits 8  
                  Parity Even  
                  Stop bits 1

For the Modbus RTU RS485, the communication parameters are adjusted via Port B.

For more information, see the separate interface manual.

If an interface board is used, access to the analog output (terminal 15/16) is not possible, except for the HART and Modbus RTU RS485 interfaces.

## PROGRAMMING THE M2000 METER

The M2000 transmitter comes pre-programmed from the factory. Typically, you do not need to do any additional programming. However, to take advantage of special features, you can program the meter for your specific needs. If you are programming the meter, familiarize yourself with the Function Buttons and Displays, and follow the procedures outlined in this manual.

### Function Buttons

All M2000 meter programming is accomplished using the three function buttons located on the front of the transmitter:



Figure 26: Function buttons

**NOTE:** Throughout this manual, the buttons are referred to as: [↑] or [+] and [↓] or [-], depending on the context. The “Enter” button is referred to as [E].



Consider the Up Arrow [ + | ↑ ] button as the “next step” or “scroll text up” button. During programming, press this button to display the next menu selection or increment a numeral.

**Example 1:** [Figure 27](#) shows the *Start Menu*. The selection arrow points to the *Exit this Menu* selection.

To scroll up to the next selection, press [↑] once. The menu text scrolls up to the next menu selection, *Main Menu*.



Figure 27: Scroll up

**Example 2:** Some procedures require you to enter a numeric value. Use the [+] button to increment the selected numeral. [Figure 28](#) shows the *Low Flow Cutoff* parameter display. Notice the cursor under the 2. In this case, press [+] once to increment the numeral to the value of 3.00%.

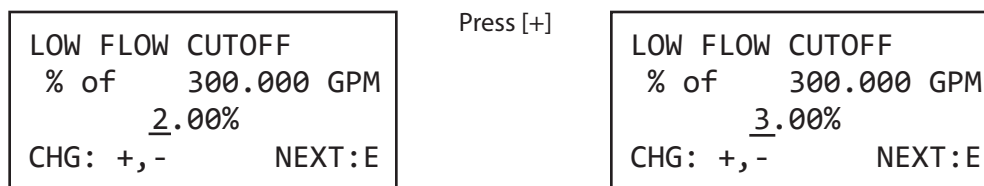

Figure 28: Enter a numeric value



Consider the Down Arrow [ - | ↓ ] button as the “previous step” button. During a procedure, press this button to return to the previous selection or decrement a numeral.

**Example 1:** *Figure 29* shows the *Main Menu*. The selection arrow points to the *Meter Setup* selection. Press [↓] once to scroll the text down to the *Exit this Menu* selection (which is not visible on the display).



Figure 29: Go to previous step

**Example 2:** For procedures that require you to enter a numeric value, use the [-] button to decrement the selected numeral. *Figure 30* shows the *Low Flow Cutoff* parameter display. Notice the cursor under the 3. In this case, press the [-] once to decrement the numeral to the value of 2.00 %.

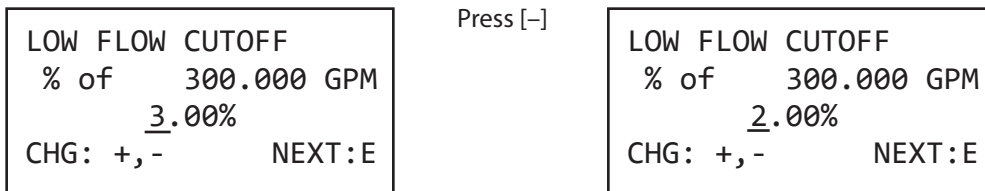

Figure 30: Decrease a value



The [E] button functions as an “Enter” button or “cursor right” button.

**Example 1:** *Figure 31* shows the *Main Menu*. The selection arrow points to the *Meter Setup* selection. Press [E] to select Meter Setup and open the *Meter Setup* display.



Figure 31: Go to meter setup

When you are entering a numeric value, the [E] button does not function as the “Enter” button, but rather, moves the cursor to the right. When the cursor is at the right-most position, the [E] then serves as the Enter key.

**Example 2:** The illustration below shows the *Low Flow Cutoff* display. The cursor is under the 3 in the ones' place. In this case, press [E] to move the cursor to the right one digit.



Figure 32: Move the cursor to the right

## Displays

There are two types of displays on the M2000 meter:

- Menu Selection
- Numeric Entry

### Menu Selection Display

Menu selection displays appear in the following format:



Figure 33: Menu selection displays

The top line shows the title of the display screen. Below are two menu selections. The bottom line provides directions for user input.

Typically, a menu contains more options than fit in the two menu selection lines. Press the [↑] and [↓] buttons to scroll the display text up and down one line at a time. When the arrow is pointed to a menu option, press [E] to select the item and open its display.

### Numeric Entry Display

Numeric entry displays appear in the following format:



Figure 34: Numeric entry displays

The top line shows the title of the display screen. The second line is a description of the value. The third line shows the current value. The bottom line provides directions for user input.

The bottom line of a numeric-value display provides prompts regarding the function of each button. The [+] and [-] buttons change the value of the numeral. The [E] button moves the cursor one digit to the right. When the cursor is at the final, right-most digit, pressing [E] repositions the cursor at the left-most digit. The bottom line display changes to reflect the new function of the [E] button. Press [E] to save the current entry. Press [+] to edit the current entry.

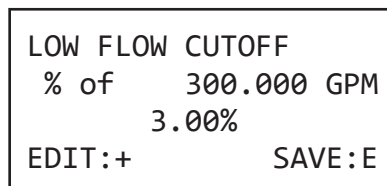

Figure 35: Title, value description, current value, directions to user

Details on how to change and set numeric values are described in ["Function Buttons" on page 27](#).

## Security

The M2000 meter security feature gives you the option to restrict access to the meter with a five-digit Personal Identification Number (PIN). The system administrator can set up a single PIN for each of the three levels of access:

- **Administration** – allows access to all menu configuration screens.
- **Service** – allows access to service-level and user-level menu configuration screens.
- **User** – allows access only to user-level menu configuration screens.

Not all levels of access need to be set. If no PINs are set up, any user has access to all functions.

**NOTE:** The security settings also apply to remote access. All remote access to the meter is blocked unless the user is remotely logged in.

### Setting the Administration PIN

Users logged in with an Administration PIN have access to all menu configuration screens.

To set the administrator's PIN, follow these steps from the *Advanced* menu:

1. Select **Security** to view the *Security* menu.
2. Select **Set Admin PIN** to view the *Admin PIN* display.
3. Set the five-digit PIN number.
4. Press [E] to save the PIN and to return to the *Security* menu.

### Setting the Service PIN

Users logged in with a Service PIN have access to service level menu configuration screens. Service level users do not have access to administrative screens.

**NOTE:** To set a service level PIN, you must first set up an administration PIN, and you must be logged in with the administration PIN.

To set the Service PIN, follow these steps from the *Advanced* menu:

1. Select **Security** to view the *Security* menu.
2. Select **Set Service PIN** to view the *Service PIN* display.
3. Set the five-digit PIN number.
4. Press [E] to save the PIN and to return to the *Security* menu.

### Setting the User PIN

Users logged in with a User PIN have access to user-level procedures. Users do not have access to administrative or service screens.

**NOTE:** In order to set a user-level PIN, you must first set up an administration PIN and a service PIN, and you must be logged in with either PIN.

To set a User PIN, follow these steps from the *Advanced* menu:

1. Select **Security** to view the *Security* menu.
2. Select **Set User PIN** to view the *User PIN* display.
3. Set the five-digit PIN number.
4. Press [E] to save the PIN and to return to the *Security* menu.

## Entering Your Personal Identification Number (PIN)

If your system has been set up with PIN security, you need to enter a PIN to access programming functions. There are three access levels, each with its own unique PIN: User, Service and Administration. Your system administrator can provide you with the appropriate PIN.

**NOTE:** All PINs are factory set to 00000. If the system administrator has not set the PIN, pressing [E] from the *Start Screen* opens the *Main Menu*.

If you forget or misplace your PIN, call Badger Meter Customer Service to get a master password. When you call, have the security code that appears in the upper right corner of the *PIN Request* display.

Follow these steps to enter your PIN in the M2000 meter:

1. At the *Main Menu*, press [E]. The *PIN Request* display opens.

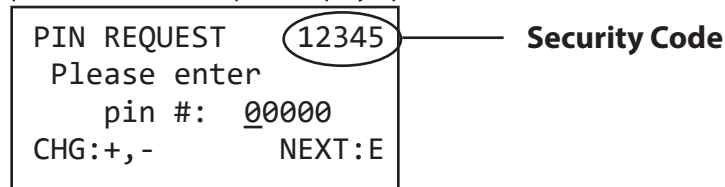

Figure 36: PIN request

2. Press [+] to increment the numeral.
3. Press [E] to move the cursor to the next digit.
4. Repeat the steps to enter each of the five digits to match your PIN.
5. Press [E]. If you entered a valid PIN, the *Main Menu* opens indicating your level of access.

If you entered the wrong PIN, the following displays:

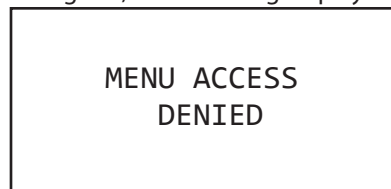

Figure 37: Wrong PIN entered

- Press [E] to return to the *PIN Request* display.
- Repeat Steps 1 through 5.

**NOTE:** Be sure to log off when you have completed work with the meter. Otherwise, there is a five-minute delay between your last activity and the time when the meter automatically logs you off.

## Setting Up the M2000 Meter with Quick Setup

The M2000 electromagnetic flow meter provides you with a Quick Setup utility that allows you to set or change your Flow Units, Totalizer Units, Full Scale Flow and Low Flow Cutoff settings. To open the *Quick Setup* menu, select **Quick Setup** from the *Start Menu*.

<b>Quick Setup</b>																																													
<p><b>Flow Unit</b> [Region]</p>	<p>Use Flow Unit to set the unit of measure for the flow rate and Full Scale Flow. To change the Flow Unit value, follow these steps from the <i>Quick Setup</i> menu.</p> <ol style="list-style-type: none"> <li>1. Select <b>Flow Unit</b> to view the <i>Flow Unit</i> display.</li> <li>2. Press [<math>\uparrow</math>] or [<math>\downarrow</math>] to position the arrow next to one of the following Flow Units: <table border="1" style="margin-left: 20px;"> <thead> <tr> <th><b>Code</b></th> <th><b>Flow Unit</b></th> <th><b>Code</b></th> <th><b>Flow Unit</b></th> </tr> </thead> <tbody> <tr> <td>LPS</td> <td>Liters/Second</td> <td>GPM</td> <td>Gallons/Minute</td> </tr> <tr> <td>LPM</td> <td>Liters/Minute</td> <td>GPH</td> <td>Gallons/Hour</td> </tr> <tr> <td>LPH</td> <td>Liters/Hour</td> <td>MGD</td> <td>Mega Gallons/Day</td> </tr> <tr> <td>M<sup>3</sup>S</td> <td>Cubic Meters/Second</td> <td>IGS</td> <td>UKG/Second</td> </tr> <tr> <td>M<sup>3</sup>M</td> <td>Cubic Meters/Minute</td> <td>IGM</td> <td>UKG/Minute</td> </tr> <tr> <td>M<sup>3</sup>H</td> <td>Cubic Meters/Hour</td> <td>IGH</td> <td>UKG/Hour</td> </tr> <tr> <td>F<sup>3</sup>S</td> <td>Cubic Feet/Second</td> <td>MID</td> <td>MegaUKG/day</td> </tr> <tr> <td>F<sup>3</sup>M</td> <td>Cubic Feet/Minute</td> <td>LbM</td> <td>Pounds/Minute</td> </tr> <tr> <td>F<sup>3</sup>H</td> <td>Cubic Feet/Hour</td> <td>OPM</td> <td>Ounces/Minute</td> </tr> <tr> <td>GPS</td> <td>Gallons/Second</td> <td>BPM</td> <td>Barrels/Minute</td> </tr> </tbody> </table> </li> <li>3. Press [<b>E</b>] to save the Flow Units setting.</li> </ol>	<b>Code</b>	<b>Flow Unit</b>	<b>Code</b>	<b>Flow Unit</b>	LPS	Liters/Second	GPM	Gallons/Minute	LPM	Liters/Minute	GPH	Gallons/Hour	LPH	Liters/Hour	MGD	Mega Gallons/Day	M <sup>3</sup> S	Cubic Meters/Second	IGS	UKG/Second	M <sup>3</sup> M	Cubic Meters/Minute	IGM	UKG/Minute	M <sup>3</sup> H	Cubic Meters/Hour	IGH	UKG/Hour	F <sup>3</sup> S	Cubic Feet/Second	MID	MegaUKG/day	F <sup>3</sup> M	Cubic Feet/Minute	LbM	Pounds/Minute	F <sup>3</sup> H	Cubic Feet/Hour	OPM	Ounces/Minute	GPS	Gallons/Second	BPM	Barrels/Minute
<b>Code</b>	<b>Flow Unit</b>	<b>Code</b>	<b>Flow Unit</b>																																										
LPS	Liters/Second	GPM	Gallons/Minute																																										
LPM	Liters/Minute	GPH	Gallons/Hour																																										
LPH	Liters/Hour	MGD	Mega Gallons/Day																																										
M <sup>3</sup> S	Cubic Meters/Second	IGS	UKG/Second																																										
M <sup>3</sup> M	Cubic Meters/Minute	IGM	UKG/Minute																																										
M <sup>3</sup> H	Cubic Meters/Hour	IGH	UKG/Hour																																										
F <sup>3</sup> S	Cubic Feet/Second	MID	MegaUKG/day																																										
F <sup>3</sup> M	Cubic Feet/Minute	LbM	Pounds/Minute																																										
F <sup>3</sup> H	Cubic Feet/Hour	OPM	Ounces/Minute																																										
GPS	Gallons/Second	BPM	Barrels/Minute																																										
<p><b>Totalizer Unit</b> [Region]</p>	<p>Use Totalizer Unit to establish the units of measure for the totalizers. To change the Totalizer Unit value, follow these steps from the <i>Totalizer Unit</i> display.</p> <ol style="list-style-type: none"> <li>1. Press [<math>\uparrow</math>] or [<math>\downarrow</math>] to position the arrow next to one of the following Totalizer Units: <table border="1" style="margin-left: 20px;"> <thead> <tr> <th><b>Code</b></th> <th><b>Totalizer Unit</b></th> <th><b>Code</b></th> <th><b>Totalizer Unit</b></th> </tr> </thead> <tbody> <tr> <td>L</td> <td>Liter</td> <td>UKG</td> <td>Imperial Gallon</td> </tr> <tr> <td>HL</td> <td>Hectoliter</td> <td>MIG</td> <td>Mega Imperial Gallons</td> </tr> <tr> <td>M<sup>3</sup></td> <td>Cubic Meter</td> <td>Lb</td> <td>Pound</td> </tr> <tr> <td>CFt</td> <td>Cubic Feet</td> <td>Oz</td> <td>Fluid Ounce</td> </tr> <tr> <td>USG</td> <td>U.S. Gallon</td> <td>Aft</td> <td>Acre Feet</td> </tr> <tr> <td>MG</td> <td>Mega Gallon</td> <td>BBL</td> <td>Barrel</td> </tr> </tbody> </table> </li> <li>2. Press [<b>E</b>] to save the Totalizer Units setting.</li> </ol>	<b>Code</b>	<b>Totalizer Unit</b>	<b>Code</b>	<b>Totalizer Unit</b>	L	Liter	UKG	Imperial Gallon	HL	Hectoliter	MIG	Mega Imperial Gallons	M <sup>3</sup>	Cubic Meter	Lb	Pound	CFt	Cubic Feet	Oz	Fluid Ounce	USG	U.S. Gallon	Aft	Acre Feet	MG	Mega Gallon	BBL	Barrel																
<b>Code</b>	<b>Totalizer Unit</b>	<b>Code</b>	<b>Totalizer Unit</b>																																										
L	Liter	UKG	Imperial Gallon																																										
HL	Hectoliter	MIG	Mega Imperial Gallons																																										
M <sup>3</sup>	Cubic Meter	Lb	Pound																																										
CFt	Cubic Feet	Oz	Fluid Ounce																																										
USG	U.S. Gallon	Aft	Acre Feet																																										
MG	Mega Gallon	BBL	Barrel																																										



<b>Quick Setup</b>	
<b>Full Scale Flow</b>	<p>Use Full Scale Flow to set the maximum flow the system is expected to measure. This parameter influences other system parameters, including:</p> <ul style="list-style-type: none"> <li>• Frequency Output – Full scale frequency is observed at Full Scale Flow</li> <li>• Low Flow Cutoff – Changes to Full Scale Flow affect the measuring cut-off threshold of the meter</li> <li>• Alarm Outputs – Changes to Full Scale Flow adjust the thresholds for generating set point alarms</li> <li>• Pulse Outputs – Changes to Full Scale Flow adjust the pulse frequency and duty cycle</li> <li>• Analog Outputs – Changes to Full Scale Flow adjust the interpretation of the analog output signal</li> </ul> <p>Change the Full Scale Flow based on the meter size and the application's requirements. Verify that the Full Scale Flow falls within the meter suggested flow range limits. In terms of flow velocity, the meter limits are 0.1...39.4 feet/second. The Full Scale Flow is valid for both flow directions.</p> <p><b>NOTE:</b> If the flow rate exceeds the full scale setting, an error message indicates the configured full scale range has been exceeded. However, the meter continues to measure. This affects the latency of the pulse outputs and may cause overflow. Furthermore, the analog output may be placed in alarm mode.</p> <p>To set or change the Full Scale Flow, follow these steps from the <i>Quick Setup</i> menu:</p> <ol style="list-style-type: none"> <li>1. Select <b>Full Scale Flow</b> to view the <i>Full Scale Flow</i> display.</li> <li>2. Select a value for Full Scale Flow.</li> <li>3. Press <b>[E]</b> to save the Full Scale Flow value and return to the <i>Measurements</i> menu.</li> </ol>
<b>Low Flow Cutoff</b>	<p>Low Flow Cutoff defines the threshold at which flow measurement is forced to zero. The cutoff value can be set at 0...10% of the Full Scale Flow. Increasing this threshold helps prevent false readings during "no flow" conditions possibly caused by pipe vibration or inherent system noise.</p> <p>To change Low Flow Cutoff, follow these steps from the <i>Low Flow Cutoff</i> display.</p> <ol style="list-style-type: none"> <li>1. Select a value for Low Flow Cutoff, between 0% and 10%.</li> <li>2. Press <b>[E]</b> to save the value.</li> </ol>

## Menu Structure

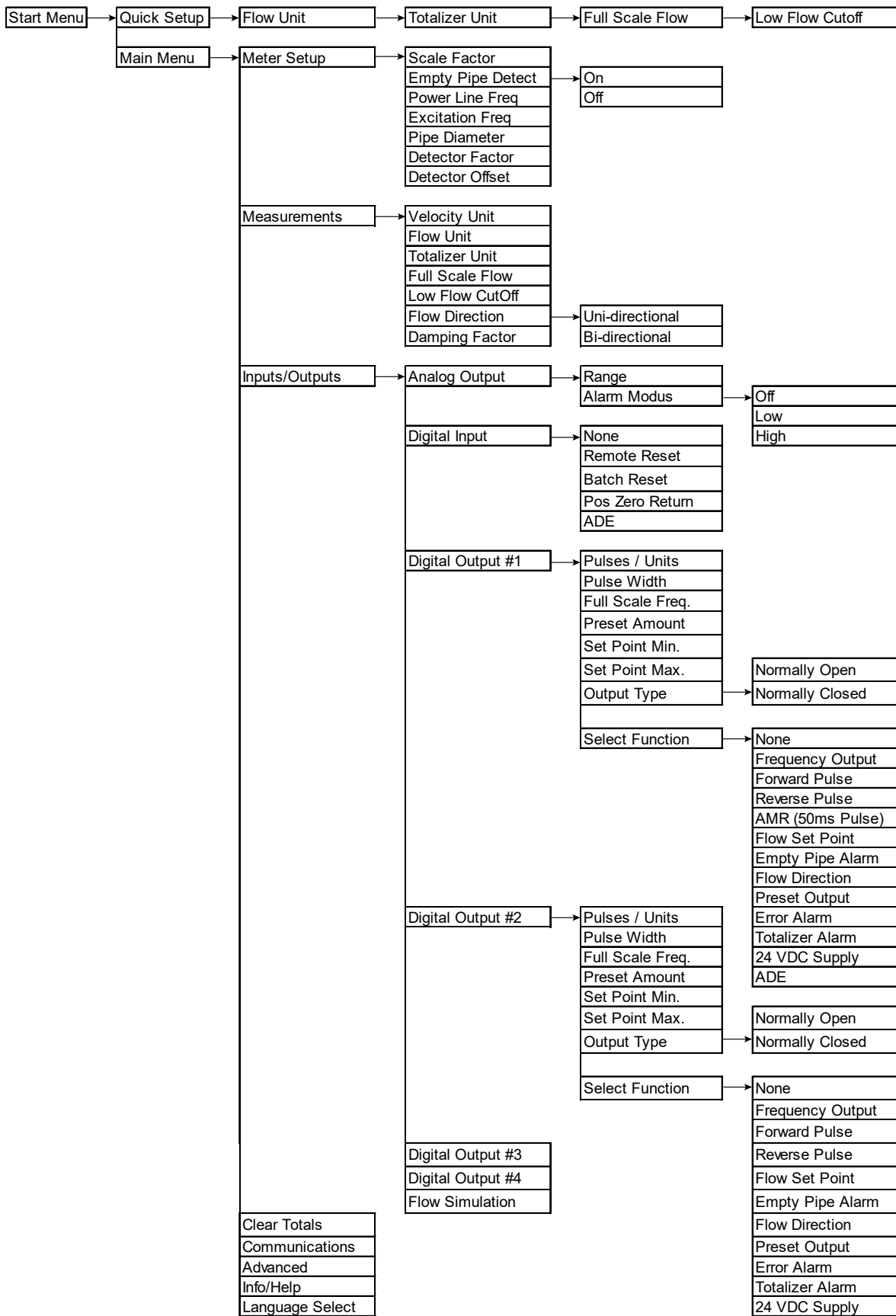

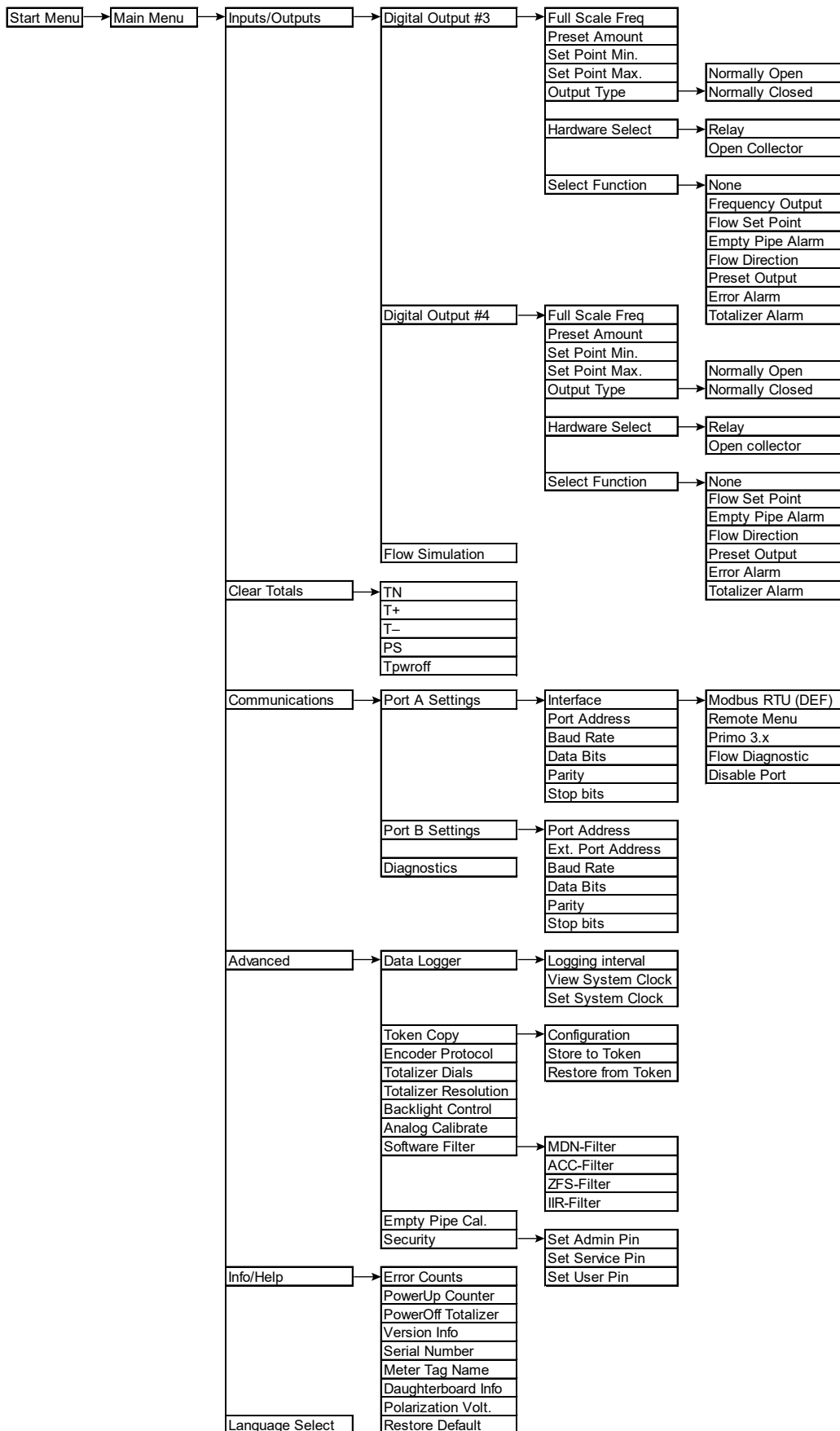

## USING THE MAIN MENU PROGRAMMING OPTIONS

The following programming options are available from the *Main Menu*:

- *Meter Setup*
- *Measurements*
- *Inputs/Outputs*
- *Clear Totals*
- *Communications*
- *Advanced*
- *Info/Help*
- *Language Select*

In the section that follows, the applicable security level for each menu option is indicated as follows:



Administrative



Service





User





Options that can be set at *Quick Setup* are indicated with:











The factory default values are shown, enclosed in brackets.



**NOTE:** Options labeled [Factory Set] should not be changed without specific directions from authorized Badger Meter personnel.

<b>Meter Setup</b>	
<p><b>scale factor</b> [0.0%]</p> 	<p>Changing the scale factor lets you adjust the meter accuracy without disturbing factory-set parameters. You can tune the meter to meet changing application requirements. For example, if the meter is under registering by 0.5%, set the scale factor to +0.5%. If the meter is over registering by 0.5%, the scale factor to -0.5%.</p> <p>To set the scale factor, follow these steps from the <i>Meter Setup</i> menu:</p> <ol style="list-style-type: none"> <li>1. Select <b>scale factor</b>, to open the <i>scale factor</i> display.</li> <li>2. Select a value for scale factor.</li> <li>3. Press [<b>E</b>], to save the new value and return to the <i>Meter Setup</i> menu.</li> </ol>
<p><b>Empty Pipe Detect</b> [ON]</p> 	<p>When set to On, Empty Pipe Detect indicates to the outputs and the display that the meter is not completely filled. When set to Off, empty pipe detect is disabled.</p> <p>Enabling empty pipe detect requires a one-time calibration. Calibration is described in the <i>Advanced</i> menu section under Empty Pipe Cal.</p> <p>To set Empty Pipe Detect, follow these steps from the <i>Meter Setup</i> menu:</p> <ol style="list-style-type: none"> <li>1. Select <b>Empty Pipe Detect</b> to view the <i>Empty Pipe Detect</i> display.</li> <li>2. Position the arrow next to <b>On</b> or <b>Off</b>.</li> <li>3. Press [<b>E</b>] to save the setting and return to the <i>Meter Setup</i> menu.</li> </ol>
<p><b>Power Line Freq</b> [Region]</p> 	<p>Power Line Freq provides measuring immunity to industrial noise from a power supply feed.</p> <p>To set Power Line Frequency, follow these steps from the <i>Meter Setup</i> menu:</p> <ol style="list-style-type: none"> <li>1. Select <b>Power Line Freq</b> to view the <i>Power Line Frequency</i> display.</li> <li>2. Position the arrow next to <b>50 Hz</b> or <b>60 Hz</b>.</li> <li>3. Press [<b>E</b>] to save the setting and return to the <i>Meter Setup</i> menu.</li> </ol>



<b>Meter Setup</b>											
<p><b>Excitation Freq</b> [Factory Set]</p> 	<p>Use Excitation Freq to configure the DC excitation of the coils. Supported frequencies are dependent on the configured power line frequency:</p> <table border="1" style="margin-left: auto; margin-right: auto;"> <thead> <tr> <th style="text-align: center;">50 Hz</th> <th style="text-align: center;">60 Hz</th> </tr> </thead> <tbody> <tr> <td style="text-align: center;">1 Hz</td> <td style="text-align: center;">1 Hz</td> </tr> <tr> <td style="text-align: center;">3.125 Hz</td> <td style="text-align: center;">3.75 Hz</td> </tr> <tr> <td style="text-align: center;">6.25 Hz</td> <td style="text-align: center;">7.5 Hz</td> </tr> <tr> <td style="text-align: center;">12.5 Hz</td> <td style="text-align: center;">15 Hz</td> </tr> </tbody> </table> <p>To change Excitation Frequency, follow these steps from the <i>Meter Setup</i> menu:</p> <ol style="list-style-type: none"> <li>1. Select <b>Excitation Freq</b> to view the <i>Excitation Frequency</i> display.</li> <li>2. Position the arrow to select a frequency.</li> <li>3. Press [E] to save the setting and return to the <i>Meter Setup</i> menu.</li> </ol>	50 Hz	60 Hz	1 Hz	1 Hz	3.125 Hz	3.75 Hz	6.25 Hz	7.5 Hz	12.5 Hz	15 Hz
50 Hz	60 Hz										
1 Hz	1 Hz										
3.125 Hz	3.75 Hz										
6.25 Hz	7.5 Hz										
12.5 Hz	15 Hz										
<p><b>Pipe Diameter</b> [Factory Set]</p> 	<p>If the transmitter is replaced, verify that the pipe diameter matches the installed pipe size.</p> <p>To change Pipe Diameter, follow these steps from the <i>Meter Setup</i> menu:</p> <ol style="list-style-type: none"> <li>1. Select <b>Pipe Diameter</b> to open the <i>Pipe Diameter</i> display.</li> <li>2. Position the arrow to select a diameter.</li> <li>3. Press [E] to save the setting and return to the <i>Meter Setup</i> menu.</li> </ol>										
<p><b>Sensor Factor</b> [Factory Set]</p> 	<p>Use Sensor Factor to compensate for accuracy error as a result of the installed sensor. If accuracy adjustment of the meter is required, see the scale factor parameter.</p> <p>If the transmitter is replaced, this parameter must be reprogrammed with the original sensor factor.</p>										
<p><b>Sensor Offset</b> [Factory Set]</p> 	<p>Use Sensor Offset to compensate for accuracy error as a result of the installed sensor. If accuracy adjustment of the meter is required, see the scale factor parameter.</p> <p><b>NOTE:</b> Changes of the sensor offset have an impact on meter accuracy at low flow.</p>										





<b>Measurements</b>																																													
<p><b>Velocity Unit</b> [Region]</p> 	<p>Use Velocity Unit to set the velocity to meters/sec or feet/sec. To set Velocity Unit, follow these steps from the <i>Measurements</i> menu:</p> <ol style="list-style-type: none"> <li>1. Select <b>Velocity Unit</b>.</li> <li>2. Position the arrow to select <b>meters/sec</b> or <b>feet/sec</b>.</li> <li>3. Press <b>[E]</b> to save the setting and return to the <i>Measurements</i> menu.</li> </ol>																																												
<p><b>Flow Units</b> [Region]</p> 	<p>Use Flow Units to set the unit of measure for the flow rate and Full Scale Flow. Changing the flow units parameter readjusts the Full Scale Flow parameter. For example, changing from gpm to gps would change the Full Scale Flow from 60 gpm to 1 gps. To change the Flow Unit, follow these steps from the <i>Measurements</i> menu:</p> <ol style="list-style-type: none"> <li>1. Select <b>Flow Units</b> to view the <i>Flow Units</i> display.</li> <li>2. Position the arrow next to one of the following flow unit options:</li> </ol> <table border="1" style="width: 100%; border-collapse: collapse;"> <thead> <tr> <th><b>Code</b></th> <th><b>Flow Unit</b></th> <th><b>Code</b></th> <th><b>Flow Unit</b></th> </tr> </thead> <tbody> <tr> <td>LPS</td> <td>Liters/Second</td> <td>GPM</td> <td>Gallons/Minute</td> </tr> <tr> <td>LPM</td> <td>Liters/Minute</td> <td>GPH</td> <td>Gallons/Hour</td> </tr> <tr> <td>LPH</td> <td>Liters/Hour</td> <td>MGD</td> <td>Mega Gallons/Day</td> </tr> <tr> <td>M<sup>3</sup>S</td> <td>Cubic Meters/Second</td> <td>IGS</td> <td>UKG/Second</td> </tr> <tr> <td>M<sup>3</sup>M</td> <td>Cubic Meters/Minute</td> <td>IGM</td> <td>UKG/Minute</td> </tr> <tr> <td>M<sup>3</sup>H</td> <td>Cubic Meters/Hour</td> <td>IGH</td> <td>UKG/Hour</td> </tr> <tr> <td>F<sup>3</sup>S</td> <td>Cubic Feet/Second</td> <td>MID</td> <td>Mega UKG/Day</td> </tr> <tr> <td>F<sup>3</sup>M</td> <td>Cubic Feet/Minute</td> <td>LbM</td> <td>Pounds/Minute</td> </tr> <tr> <td>F<sup>3</sup>H</td> <td>Cubic Feet/Hour</td> <td>OPM</td> <td>Ounces/Minute</td> </tr> <tr> <td>GPS</td> <td>Gallons/Second</td> <td>BPM</td> <td>Barrels/Minute</td> </tr> </tbody> </table> <ol style="list-style-type: none"> <li>3. Press <b>[E]</b> to save the flow units and return to the <i>Measurements</i> menu.</li> </ol>	<b>Code</b>	<b>Flow Unit</b>	<b>Code</b>	<b>Flow Unit</b>	LPS	Liters/Second	GPM	Gallons/Minute	LPM	Liters/Minute	GPH	Gallons/Hour	LPH	Liters/Hour	MGD	Mega Gallons/Day	M <sup>3</sup> S	Cubic Meters/Second	IGS	UKG/Second	M <sup>3</sup> M	Cubic Meters/Minute	IGM	UKG/Minute	M <sup>3</sup> H	Cubic Meters/Hour	IGH	UKG/Hour	F <sup>3</sup> S	Cubic Feet/Second	MID	Mega UKG/Day	F <sup>3</sup> M	Cubic Feet/Minute	LbM	Pounds/Minute	F <sup>3</sup> H	Cubic Feet/Hour	OPM	Ounces/Minute	GPS	Gallons/Second	BPM	Barrels/Minute
<b>Code</b>	<b>Flow Unit</b>	<b>Code</b>	<b>Flow Unit</b>																																										
LPS	Liters/Second	GPM	Gallons/Minute																																										
LPM	Liters/Minute	GPH	Gallons/Hour																																										
LPH	Liters/Hour	MGD	Mega Gallons/Day																																										
M <sup>3</sup> S	Cubic Meters/Second	IGS	UKG/Second																																										
M <sup>3</sup> M	Cubic Meters/Minute	IGM	UKG/Minute																																										
M <sup>3</sup> H	Cubic Meters/Hour	IGH	UKG/Hour																																										
F <sup>3</sup> S	Cubic Feet/Second	MID	Mega UKG/Day																																										
F <sup>3</sup> M	Cubic Feet/Minute	LbM	Pounds/Minute																																										
F <sup>3</sup> H	Cubic Feet/Hour	OPM	Ounces/Minute																																										
GPS	Gallons/Second	BPM	Barrels/Minute																																										
<p><b>Totalizer Unit</b> [Region]</p> 	<p>Use the Totalizer Unit to establish the units of measure for the totalizers. To change the Totalizer Unit value, follow these steps from the <i>Measurements</i> menu:</p> <ol style="list-style-type: none"> <li>1. Select <b>Totalizer Unit</b> to view the <i>Totalizer Unit</i> display.</li> <li>2. Position the arrow next to one of the following totalizer units:</li> </ol> <table border="1" style="width: 100%; border-collapse: collapse;"> <thead> <tr> <th><b>Code</b></th> <th><b>Totalizer Unit</b></th> <th><b>Code</b></th> <th><b>Totalizer Unit</b></th> </tr> </thead> <tbody> <tr> <td>L</td> <td>Liters</td> <td>MIG</td> <td>Mega Imperial Gallons</td> </tr> <tr> <td>HL</td> <td>Hectoliters</td> <td>Lb</td> <td>Pounds</td> </tr> <tr> <td>M<sup>3</sup></td> <td>Cubic Meters</td> <td>Oz</td> <td>Fluid Ounces</td> </tr> <tr> <td>CFt</td> <td>Cubic Feet</td> <td>Aft</td> <td>Acre Feet</td> </tr> <tr> <td>USG</td> <td>U.S. Gallons</td> <td>BBL</td> <td>Barrels</td> </tr> <tr> <td>MG</td> <td>Mega Gallons</td> <td>SFD</td> <td>Second Foot Day</td> </tr> <tr> <td>UKG</td> <td>Imperial Gallons</td> <td></td> <td></td> </tr> </tbody> </table> <ol style="list-style-type: none"> <li>3. Press <b>[E]</b> to save the totalizer unit and return to the <i>Measurements</i> menu.</li> </ol>	<b>Code</b>	<b>Totalizer Unit</b>	<b>Code</b>	<b>Totalizer Unit</b>	L	Liters	MIG	Mega Imperial Gallons	HL	Hectoliters	Lb	Pounds	M <sup>3</sup>	Cubic Meters	Oz	Fluid Ounces	CFt	Cubic Feet	Aft	Acre Feet	USG	U.S. Gallons	BBL	Barrels	MG	Mega Gallons	SFD	Second Foot Day	UKG	Imperial Gallons														
<b>Code</b>	<b>Totalizer Unit</b>	<b>Code</b>	<b>Totalizer Unit</b>																																										
L	Liters	MIG	Mega Imperial Gallons																																										
HL	Hectoliters	Lb	Pounds																																										
M <sup>3</sup>	Cubic Meters	Oz	Fluid Ounces																																										
CFt	Cubic Feet	Aft	Acre Feet																																										
USG	U.S. Gallons	BBL	Barrels																																										
MG	Mega Gallons	SFD	Second Foot Day																																										
UKG	Imperial Gallons																																												



<b>Measurements</b>	
<p><b>Full Scale Flow</b> [Factory Set]</p>  	<p>Use Full Scale Flow to set the maximum flow the system is expected to measure. This parameter has influence on other system parameters, which include:</p> <ul style="list-style-type: none"> <li>• Frequency Output – Full scale frequency is observed at Full Scale Flow</li> <li>• Low Flow Cutoff – Changes to Full Scale Flow affect the measuring cut-off threshold of the meter</li> <li>• Alarm Outputs – Changes to Full Scale Flow adjust the thresholds for generating set point alarms</li> <li>• Pulse Outputs – Changes to Full Scale Flow adjust the pulse frequency and duty cycle</li> <li>• Analog Outputs – Changes to Full Scale Flow adjust the interpretation of the analog output signal</li> </ul> <p>Change the Full Scale Flow based on the meter size and the application requirements. Verify that the Full Scale Flow falls within the meter suggested flow range limits. The flow velocity limits range from 0.1...39.4 feet/second. Full Scale Flow is valid for both flow directions.</p> <p><b>NOTE:</b> If the flow rate exceeds the full scale setting, an error message indicates that the configured full scale range has been exceeded. However, the meter continues to measure. This affects the latency of the pulse outputs and possibly causes overflow. Analog output may also be placed in alarm mode.</p> <p>To change the Full Scale Flow, follow these steps from the <i>Measurements</i> menu:</p> <ol style="list-style-type: none"> <li>1. Select <b>Full Scale Flow</b> to view the <i>Full Scale Flow</i> display.</li> <li>2. Select a value for Full Scale Flow.</li> <li>3. Press [E] to save the Full Scale Flow value and return to the <i>Measurements</i> menu.</li> </ol>
<p><b>Low Flow Cutoff</b> [0.2%]</p>  	<p>Low flow cutoff defines the threshold at which flow measurement is forced to zero. The cutoff value can be set at 0...10% of the Full Scale Flow. Increasing this threshold helps prevent false readings during “no flow” conditions possibly caused by pipe vibration or inherent system noise.</p> <p>To change the Low Flow Cutoff value, follow these steps from the <i>Measurements</i> menu:</p> <ol style="list-style-type: none"> <li>1. Select <b>Low Flow Cutoff</b> to view the <i>Low Flow Cutoff</i> display.</li> <li>2. Select a value for low flow cutoff.</li> <li>3. Press [E] to save the new low flow cutoff value and return to the <i>Measurements</i> menu.</li> </ol>
<p><b>Flow Direction</b> [Bi-Directional]</p> 	<p>Use Flow Direction to set the meter to measure forward flow only (uni-directional) or both forward and reverse flow (bidirectional).</p> <p><b>Uni-Directional</b> Flow is totalized in only one direction. The flow direction is indicated by the arrow on the sensor label. Uni-directional measurements on the main display screen include:</p> <ul style="list-style-type: none"> <li>• T1: Registers forward flow, resettable by menu or MODBUS RTU</li> <li>• T2: Registers forward flow, resettable by menu, MODBUS RTU or digital input configured for Remote Reset</li> </ul> <p><b>Bi-Directional</b> Flow is totalized in both directions. Bidirectional measurements on the main display screen include:</p> <ul style="list-style-type: none"> <li>• T+: Registers forward flow, resettable by menu or MODBUS RTU</li> <li>• T-: Registers reverse flow, resettable by menu or MODBUS RTU</li> <li>• TN: Registers total flow, T+, T-, resettable by menu or MODBUS RTU</li> </ul> <p>To change the flow direction follow these steps from the <i>Measurements</i> menu.</p> <ol style="list-style-type: none"> <li>1. Select <b>Flow Direction</b> to view the <i>Flow Direction</i> display.</li> <li>2. Select <b>Uni-Directional</b> or <b>Bi-Directional</b>.</li> <li>3. Press [E] to save the flow direction and return to the <i>Measurements</i> menu.</li> </ol> <p>A change of the flow direction can be signaled by the digital outputs.</p>

<b>Measurements</b>											
<b>Damping Factor</b> [5 s] 	<p>Use Damping Factor to establish the stability of the measured flow rate. If back and forth oscillations of the flow rate are observed during normal flow conditions, increase this value incrementally until the flow rate stabilizes. This parameter has no affect on the totalizers.</p> <p>To change the Damping Factor value, follow these steps from the <i>Measurements</i> menu.</p> <ol style="list-style-type: none"> <li>1. Select <b>Damping Factor</b> to view the <i>Damping Factor</i> display.</li> <li>2. Select one of the following damping factors:               <table style="margin-left: 20px; border: none;"> <tr> <td>1 Second</td> <td>10 Seconds</td> </tr> <tr> <td>2 Seconds</td> <td>20 Seconds</td> </tr> <tr> <td>3 Seconds</td> <td>30 Seconds</td> </tr> <tr> <td>4 Seconds</td> <td>No Damping</td> </tr> <tr> <td>5 Seconds</td> <td></td> </tr> </table> </li> <li>3. Press <b>[E]</b> to save the damping factor and return to the <i>Measurements</i> menu.</li> </ol>	1 Second	10 Seconds	2 Seconds	20 Seconds	3 Seconds	30 Seconds	4 Seconds	No Damping	5 Seconds	
1 Second	10 Seconds										
2 Seconds	20 Seconds										
3 Seconds	30 Seconds										
4 Seconds	No Damping										
5 Seconds											
<b>Inputs/Outputs</b>											
<b>Analog Output</b> [4 to 20 mA] 	<p>Use Analog Output to establish the range of the analog output signal. To change Analog Output range, follow these steps from the <i>Inputs/Outputs</i> menu:</p> <ol style="list-style-type: none"> <li>1. Select <b>Analog Output</b> to view the <i>Analog Output</i> display.</li> <li>2. Select one of the following options:               <ul style="list-style-type: none"> <li>• 4 to 20 mA</li> <li>• 0 to 20 mA</li> <li>• 2 to 10 mA</li> <li>• 0 to 10 mA</li> </ul> </li> <li>3. Press <b>[E]</b> to save the analog output and return to the <i>Inputs/Outputs</i> menu.</li> </ol> <p><b>NOTE:</b> If an error message is displayed, set current to 22 mA. If you select bidirectional operation, you can signal flow direction via digital outputs.</p>										
<b>Alarm Mode</b> [OFF] 	<p>Use Alarm Mode to configure the behavior of the analog output during alarm conditions. There are three options for this parameter: OFF, LOW, and HIGH.</p> <p><b>OFF:</b> Analog signal is based on flow rate and always within the configured range</p> <p><b>LOW:</b> During alarm conditions, the analog signal is 2 mA less than the configured lower range</p> <p><b>HIGH:</b> During alarm conditions, the analog signal is 2 mA more than the configured upper range</p> <p>For example, if the analog range is 4...20 mA and the alarm mode is set to HIGH, then during a Full Scale Flow alarm condition, the analog output current is 22 mA.</p> <p>To change the analog output alarm mode, follow these steps from the <i>Inputs/Outputs</i> menu:</p> <ol style="list-style-type: none"> <li>1. Select <b>Alarm Mode</b> to view the <i>Alarm Mode</i> display.</li> <li>2. Select one of the following options:               <ul style="list-style-type: none"> <li>• OFF</li> <li>• LOW</li> <li>• HIGH</li> </ul> </li> <li>3. Press <b>[E]</b> to save the alarm mode and return to the <i>Inputs/Outputs</i> menu.</li> </ol>										















<b>Inputs/Outputs</b>		
<b>Digital Input</b> [Disabled]	<p>Use Digital Input to configure the functional operation of the digital input. The following functions are supported:</p> <ul style="list-style-type: none"> <li>• Remote Reset – Clears totalizer T2 (uni-directional)</li> <li>• Batch Reset – Resets batch totalizer PS to preset amount and clears T2 (uni-directional)</li> <li>• Pos Zero Return – Forces flow rate to zero (does not totalize)</li> <li>• ADE – Input configured for ADE operation. See <a href="#">“Encoder Protocol Interface” on page 57</a>.</li> </ul> <p>To change Digital Input, follow these steps from the <i>Inputs/Outputs</i> menu:</p> <ol style="list-style-type: none"> <li>1. Select <b>Digital Input</b> to view the <i>Digital Input</i> display.</li> <li>2. Select a function.</li> <li>3. Press <b>[E]</b> to save the digital input and return to the <i>Inputs/Outputs</i> menu.</li> </ol> <p>Apply an external potential of 5...30V DC or an internal voltage source of 24V DC via output #2 to enable input switching (by a normally open contact). If using the internal source, set the function of digital output #2 to “24V DC Supply”. Jumper JP2 must be placed.</p>	
<b>Digital Output</b>	<p><b>Pulses/Unit</b> [1 pulse/unit]</p> 	<p>The Pulses/Unit parameter lets you set the number of pulses per unit of measure transmitted to remote applications. For example, assuming the unit of measure is gallons:</p> <ul style="list-style-type: none"> <li>• Setting the Pulses/Unit to 1 transmits 1 pulse every gallon</li> <li>• Setting the Pulses/Unit to 0.01 transmits 1 pulse every 100 gallons</li> </ul> <p>You must configure pulses/unit if the function of the selected output is forward, reverse or AMR pulse.</p> <p>Consider this parameter with the Pulse Width and Full Scale Flow parameters. The maximum pulse frequency is 10 kHz. The frequency is correlated with the flow rate. Violation of output frequency limits generates a configuration error.</p> <p>To change the pulses/unit, follow these steps from the <i>Inputs/Outputs</i> menu:</p> <ol style="list-style-type: none"> <li>1. Select <b>Digital Output 1</b> or <b>2</b> and press <b>[E]</b> to open the <i>Digital Output</i> menu.</li> <li>2. From the <i>Digital Output</i> menu select <b>Pulses/Unit</b>, and press <b>[E]</b> to open the <i>Pulses/Unit</i> display.</li> <li>3. Enter the pulses/unit value. Press <b>[E]</b> to save the new parameter and return to the <i>Digital Output</i> menu.</li> </ol>
	<p><b>Pulse Width</b> [0 ms]</p> 	<p>Use Pulse Width to establish the On duration of the transmitted pulse. The configurable range is 0...1000 ms.</p> <ul style="list-style-type: none"> <li>• Non-zero pulse width configuration, the Off duration of the transmitted pulse, is dependent on flow rate. The Off duration should be at least the configured On duration range. At Full Scale Flow, the On duration equals the Off duration. The maximum configurable output frequency is limited to 500 Hz.</li> <li>• 0 ms pulse width configuration, the duty cycle of the transmitted pulse, is at 50 % allowing for a maximum configurable output frequency of 10 kHz.</li> </ul> <p>Consider this parameter with the Pulses/Unit and Full Scale Flow parameters. The maximum pulse frequency is 10 kHz. The frequency is correlated with the flow rate. Violation of output frequency limits generates a configuration error.</p> <p>To change the pulse width, follow these steps from the <i>Inputs/Outputs</i> menu:</p> <ol style="list-style-type: none"> <li>1. Select <b>Digital Output 1</b> or <b>2</b> and press <b>[E]</b> to open the <i>Digital Output</i> menu.</li> <li>2. From the <i>Digital Output</i> menu select <b>Pulse Width</b> and press <b>[E]</b> to open the <i>Pulse Width</i> display.</li> <li>3. Enter the pulse width value. Press <b>[E]</b> to save the new parameter and return to the <i>Digital Output</i> menu.</li> </ol>





<b>Inputs/Outputs</b>		
<b>Digital Output (continued)</b>	<b>Full Scale Frequency</b> [1000 Hz] 	Use Full Scale Frequency to establish the Full Scale Flow output frequency when the flow rate equals the configured Full Scale Flow. To change the Full Scale Frequency, follow these steps from the <i>Inputs/Outputs</i> main menu: <ol style="list-style-type: none"> <li>1. Select <b>Digital Output 1, 2 or 3</b> and press [E] to open the <i>Digital Output</i> menu.</li> <li>2. From the <i>Digital Output</i> menu select <b>Full Scale Frequency</b> and press [E] to open the <i>Full Scale Frequency</i> display.</li> <li>3. Select a value for full scale frequency.</li> <li>4. Press [E] to save the new parameter and return to the <i>Digital Output</i> menu.</li> </ol>
	<b>Preset Amount</b> [0.0] 	Use Preset Amount to set the reset value for the associated PS totalizer when the digital input is set to Batch Reset. To change the Preset Amount, follow these steps from the <i>Inputs/Outputs</i> menu: <ol style="list-style-type: none"> <li>1. Select <b>Digital Output 1, 2, 3 or 4</b> and press [E] to open the <i>Digital Output</i> menu.</li> <li>2. From the <i>Digital Output</i> menu select <b>Preset Amount</b> and press [E] to open the <i>Preset Amount</i> display.</li> <li>3. Enter the preset amount value. Press [E] to save the new parameter and return to the <i>Digital Output</i> menu.</li> </ol> <p><b>NOTE:</b> You can only set one Preset Amount. If you set the Preset Amount for Digital Output 1, it is the same for 2, 3 and 4.</p>
	<b>Set Point Minimum</b> [0%] 	Use Set Point Minimum to establish, as a percentage of Full Scale Flow, the threshold at which the output alarm is activated. Flow rates below the threshold activate the output alarm. To change the Set Point Minimum, follow these steps from the <i>Inputs/Outputs</i> menu: <ol style="list-style-type: none"> <li>1. Select <b>Digital Output 1, 2, 3 or 4</b> and press [E] to open the <i>Digital Output</i> menu.</li> <li>2. From the <i>Digital Output</i> menu select <b>Set Point Minimum</b> and press [E] to open the <i>Set Point Minimum</i> display.</li> <li>3. Enter the set point minimum value. Press [E] to save the new parameter and return to the <i>Digital Output</i> menu.</li> </ol>
	<b>Set Point Maximum</b> [100%] 	Use Set Point Maximum to establish, as a percentage of Full Scale Flow, the threshold at which the output alarm is activated. Flow rates above the threshold activate the output alarm. To change the maximum set point, follow these steps from the <i>Inputs/Outputs</i> menu: <ol style="list-style-type: none"> <li>1. Select <b>Digital Output 1, 2, 3 or 4</b> and press [E] to open the <i>Digital Output</i> menu.</li> <li>2. From the <i>Digital Output</i> menu select <b>Set Point Maximum</b> and press [E] to open the <i>Set Point Maximum</i> display.</li> <li>3. Enter the set point maximum value and press [E] to save the new parameter and return to the <i>Digital Output</i> menu.</li> </ol>



<b>Inputs/Outputs</b>		
<b>Digital Output (continued)</b>	<b>Output Type</b> [1: Normally Open] [2: Normally Open] [3: Normally Open] [4: Normally Closed] 	Use Output Type to set the output switch to normally open or normally closed. If <b>Normally Open</b> is selected, the output switch is open (no current) when the output is inactive and closed (current flows) when the output is active. If <b>Normally Closed</b> is selected, the output switch is closed (current flows) when the output is inactive and open (no current) when the output is active. To change the Output Type, follow these steps from the <i>Inputs/Outputs</i> main menu: <ol style="list-style-type: none"> <li>1. Select <b>Digital Output 1, 2, 3 or 4</b> and press [E] to open the <i>Digital Output</i> menu.</li> <li>2. From the <i>Digital Output</i> menu, select <b>Output Type</b> and press [E] to open the <i>Output Type</i> display.</li> <li>3. Select <b>Normally Open</b> or <b>Normally Closed</b>.</li> <li>4. Press [E] to save the new parameter and return to the <i>Digital Output</i> menu.</li> </ol>
	<b>Hardware Type</b> [3: Open Collector] [4: Solid-state Relay] 	Use Hardware Type to select the type of hardware used to drive the output signal: either Open Collector or Solid-state Relay. To change the Hardware Type, follow these steps from the <i>Inputs/Outputs</i> main menu: <ol style="list-style-type: none"> <li>1. Select <b>Digital Output 3 or 4</b> and press [E] to open the <i>Digital Output</i> menu.</li> <li>2. From the <i>Digital Output</i> menu select <b>Hardware Type</b> and press [E] to open the <i>Hardware Type</i> display.</li> <li>3. Select <b>Open Collector</b> or <b>Relay</b>.</li> <li>4. Press [E] to save the new parameter and return to the <i>Digital Output</i> menu.</li> </ol>

		<b>Inputs/Outputs</b>																																																																						
<b>Digital Output (continued)</b>	<p><b>Select Function</b>            [1: Forward Pulse]            [2: Reverse Pulse]            [3: Empty Pipe Detection]            [4: Error Alarm]</p> 	<p>Use Select Function to configure the functional operation of the associated output. The following operations are supported:</p> <ul style="list-style-type: none"> <li>• Frequency Output – Generates pulses correlated to the absolute value of the flow rate.</li> <li>• Forward Pulse – Generates pulses during forward flow conditions.</li> <li>• Reverse Pulse – Generates pulses during reverse flow conditions.</li> <li>• AMR (50 ms Pulse)</li> <li>• Flow Set Point – Indicates when flow rate exceeds thresholds defined by flow set points.</li> <li>• Empty Pipe Alarm – Indicates when pipe is empty.</li> <li>• Flow Direction – Indicates current flow direction (Inactive = Reverse or No Flow, Active = Forward).</li> <li>• Preset Output – Indicates when preset batch amount has been realized.</li> <li>• Error Alarm – Indicates when meter has error condition. Error conditions include empty pipe error, Full Scale Flow error and sensor error.</li> <li>• Totalizer Alarm – Sends alarm when either a rollover error or warning has occurred.</li> <li>• 24V DC Supply – Provides constant 24 volts on output (forces output type to Normally Open).</li> <li>• ADE – Provides meter information in digital format. See <a href="#">“Encoder Protocol Interface” on page 57.</a></li> </ul> <p>The following functions can be selected for outputs 1...4:</p> <table border="1"> <thead> <tr> <th>Function</th> <th>Dig Out 1</th> <th>Dig Out 2</th> <th>Dig Out 3</th> <th>Dig Out 4</th> </tr> </thead> <tbody> <tr> <td>Inactive</td> <td>X</td> <td>X</td> <td>X</td> <td>X</td> </tr> <tr> <td>Forward Pulse</td> <td>X</td> <td>X</td> <td></td> <td></td> </tr> <tr> <td>Reverse Pulse</td> <td>X</td> <td>X</td> <td></td> <td></td> </tr> <tr> <td>AMR (50 ms)</td> <td>X</td> <td></td> <td></td> <td></td> </tr> <tr> <td>Frequency Output</td> <td>X</td> <td>X</td> <td>X</td> <td></td> </tr> <tr> <td>Flow Set Point</td> <td>X</td> <td>X</td> <td>X</td> <td>X</td> </tr> <tr> <td>Empty Pipe Alarm</td> <td>X</td> <td>X</td> <td>X</td> <td>X</td> </tr> <tr> <td>Flow Direction</td> <td>X</td> <td>X</td> <td>X</td> <td>X</td> </tr> <tr> <td>Preset Output</td> <td>X</td> <td>X</td> <td>X</td> <td>X</td> </tr> <tr> <td>Error Alarm</td> <td>X</td> <td>X</td> <td>X</td> <td>X</td> </tr> <tr> <td>24V DC Supply</td> <td>X</td> <td>X</td> <td></td> <td></td> </tr> <tr> <td>ADE</td> <td>X</td> <td></td> <td></td> <td></td> </tr> <tr> <td>Totalizer Alarm</td> <td>X</td> <td>X</td> <td>X</td> <td>X</td> </tr> </tbody> </table> <p>To change Select Function, follow these steps from the <i>Inputs/Outputs</i> main menu:</p> <ol style="list-style-type: none"> <li>1. Select <b>Digital Output 1, 2, 3 or 4</b> and press [E] to open the <i>Digital Output</i> menu.</li> <li>2. From the <i>Digital Output</i> menu choose <b>Select Function</b> and press [E] to open the <i>Select Function</i> display.</li> <li>3. Select a function.</li> <li>4. Press [E] to save the setting and return to the <i>Digital Output</i> menu.</li> </ol>	Function	Dig Out 1	Dig Out 2	Dig Out 3	Dig Out 4	Inactive	X	X	X	X	Forward Pulse	X	X			Reverse Pulse	X	X			AMR (50 ms)	X				Frequency Output	X	X	X		Flow Set Point	X	X	X	X	Empty Pipe Alarm	X	X	X	X	Flow Direction	X	X	X	X	Preset Output	X	X	X	X	Error Alarm	X	X	X	X	24V DC Supply	X	X			ADE	X				Totalizer Alarm	X	X	X	X
Function	Dig Out 1	Dig Out 2	Dig Out 3	Dig Out 4																																																																				
Inactive	X	X	X	X																																																																				
Forward Pulse	X	X																																																																						
Reverse Pulse	X	X																																																																						
AMR (50 ms)	X																																																																							
Frequency Output	X	X	X																																																																					
Flow Set Point	X	X	X	X																																																																				
Empty Pipe Alarm	X	X	X	X																																																																				
Flow Direction	X	X	X	X																																																																				
Preset Output	X	X	X	X																																																																				
Error Alarm	X	X	X	X																																																																				
24V DC Supply	X	X																																																																						
ADE	X																																																																							
Totalizer Alarm	X	X	X	X																																																																				

<b>Inputs/Outputs</b>	
<b>Flow Simulation</b> [Off] 	<p>Flow Simulation provides output simulation based on a percentage of the Full Scale Flow. Simulation does not accumulate the totalizers. The range of simulation includes –100...100% of the Full Scale Flow. The Flow Simulation Parameter lets you set the range of simulation in 10% increments.</p> <p>To change the Flow Simulation, follow these steps from the <i>Inputs/Outputs</i> menu:</p> <ol style="list-style-type: none"> <li>1. Select <b>Flow Simulation</b> to view the <i>Flow Simulation</i> display.</li> <li>2. Click [+ ] to increment the percentage by 10, or click [– ] to decrement the percentage by 10.</li> <li>3. Press [E] to save the displayed setting and return to the <i>Inputs/Outputs</i> menu.</li> </ol> <p>This function remains active after exiting the menu. Set Q on “Deactivate.” If the simulation is active, the message “STS simulation” is displayed in measuring mode.</p>
<b>Clear Totals</b>	
<b>TN</b> 	<p>The bidirectional net totalizer, when reset, clears both the forward and the reverse flow totalizers (T+ and T–). It is reset within the menu manager or through remote communications. Clearing TN also clears the associated rollover counter.</p>
<b>T+</b> 	<p>The bidirectional forward flow totalizer is reset within the menu manager or through remote communications. Clearing T+ also clears the associated rollover counter.</p>
<b>T–</b> 	<p>The bidirectional reverse flow totalizer is reset within the menu manager or through remote communications. Clearing T– also clears the associated rollover counter.</p>
<b>PS</b> 	<p>The batch totalizer is reset to the configured preset amount value. It is reset within the menu manager, remote communications or through a properly configured digital input (function = batch reset).</p>
<b>Tpwroff</b> 	<p>The totalizer accumulating meter time without external power is reset with the menu manager or through remote communications.</p>
<b>T1</b> 	<p>The unidirectional totalizer T1 is reset within the menu manager.</p>
<b>T2</b> 	<p>The unidirectional totalizer T2 is reset within the menu manager or with digital input.</p>
<b>VW</b> 	<p>The preset batch is reset within the menu manager or with digital input.</p>



<b>Communication</b>		
<b>Port A Settings</b>	<b>Interface</b> [MODBUS RTU] 	Use Interface to configure how the RS232 communication port is used. <ul style="list-style-type: none"> <li>• MODBUS RTU</li> <li>• Remote menu (RDI – Remote Display Interface)</li> <li>• Primo 3.x</li> <li>• Flow diagnostic – After every flow measurement, provides data out of the communication port primarily for diagnosing flow measurement issues.</li> <li>• Disable port</li> </ul> The remote menu Interface checks for display updates once a second. If a change is detected, the display contents are transmitted in ASCII format over the RS232 communication port. The remote menu Interface also allows for menu navigation and control of the meter as if using the external push buttons. Keyboard control characters such as <UP>,<DWN> and <ENTER> are supported to navigate the menus.  The Primo 3.x Interface emulates the legacy Primo 3.x protocol. This protocol transmits an ASCII string in the following format every 500 ms: “RATE;0.0000; GPM; TOT1;150.0000; USG ; TOT2;150.0000; USG ;” – For Unidirectional Mode “RATE;0.0000; GPM; TOT+;10.0000; USG ; TOT-;50.0000; USG ;” – For Bidirectional Mode  To change the Interface follow these steps from the <i>Port A Settings</i> menu: <ol style="list-style-type: none"> <li>1. Select <b>Interface</b> to view the <i>Interface</i> display.</li> <li>2. Select an interface.</li> <li>3. Press [<b>E</b>] to save and return to the <i>Port A Settings</i> menu.</li> </ol>
	<b>Port Address</b> [1] 	Use Port Address to establish the MODBUS RTU address. MODBUS RTU requests are only processed if the configured port address of the meter matches the request address found in the MODBUS RTU packet. The range of addresses supported by MODBUS RTU is 1...247. MODBUS RTU request packets with an address of 0 imply the packet is to be treated as a broadcast packet.  To change the port address, follow these steps from the <i>Port A Settings</i> menu: <ol style="list-style-type: none"> <li>1. Select <b>Port Address</b> to view the <i>Port Address</i> display.</li> <li>2. Select a port address (<b>1...247</b>).</li> <li>3. Press [<b>E</b>] to save the option and to return to the <i>Port A Settings</i> menu.</li> </ol>
	<b>Baud Rate</b> [9600] 	The following baud rates are supported <ul style="list-style-type: none"> <li>• 9600</li> <li>• 19200</li> <li>• 38400</li> </ul> To change the baud rate, follow these steps from the <i>Port A Settings</i> menu: <ol style="list-style-type: none"> <li>1. Select <b>Baud Rate</b> to view the <i>Baud Rate</i> display.</li> <li>2. Select one of the following baud rates: <b>9600, 19200</b> or <b>38400</b>.</li> <li>3. Press [<b>E</b>] to save the option and to return to the <i>Port A Settings</i> menu.</li> </ol>



<b>Communication</b>		
<b>Port A Settings (continued)</b>	<b>Data Bits</b> [8 bits] 	The following data bits are supported: <ul style="list-style-type: none"> <li>• 8 bits</li> <li>• 7 bits</li> <li>• 5 bits</li> </ul> To change the data bits, follow these steps from the <i>Port A Settings</i> menu: <ol style="list-style-type: none"> <li>1. Select <b>Data Bits</b> to view the <i>Data Bits</i> display.</li> <li>2. Select one of the following: <b>8 Bits</b>, <b>7 Bits</b> or <b>5 Bits</b>.</li> <li>3. Press <b>[E]</b> to save the option and to return to the <i>Port A Settings</i> menu.</li> </ol>
	<b>Parity</b> [Even] 	The following parities are supported: <ul style="list-style-type: none"> <li>• Even</li> <li>• Odd</li> <li>• None</li> </ul> To change the parity, follow these steps from the <i>Port A Settings</i> menu: <ol style="list-style-type: none"> <li>1. Select <b>Parity</b> to view the <i>Parity</i> display.</li> <li>2. Select one of the following: <b>None</b>, <b>Even</b> or <b>Odd</b>.</li> <li>3. Press <b>[E]</b> to save the option and to return to the <i>Port A Settings</i> menu.</li> </ol>
	<b>Stop Bits</b> [1 Stop Bit] 	The following stop bits are supported: <ul style="list-style-type: none"> <li>• 1 Stop Bit</li> <li>• 2 Stop Bits</li> </ul> To change the stop bits, follow these steps from the <i>Port A Settings</i> menu: <ol style="list-style-type: none"> <li>1. Select <b>Stop Bits</b> to view the <i>Stop Bits</i> display.</li> <li>2. Select one of the following: <b>1 Stop Bit</b> or <b>2 Stop Bits</b>.</li> <li>3. Press <b>[E]</b> to save the option and to return to the <i>Port A Settings</i> menu.</li> </ol>
<b>Port B Settings</b>	<b>NOTE:</b> The parameters for <i>Port B</i> are the same as for <i>Port A</i> , with the exception of the additional <i>External Port Address</i> detailed below.	
	<b>Port Address</b> [1] 	An additional communication port, known as <i>Port B</i> , offers enhanced communications with the meter. This port is located on the 11-pin terminal of the PCB. Enhanced protocols like Hart, Profibus DP or Modbus RTU over RS485 are available. In addition, this communication port has similar configurable properties as port A. Refer to the following user manuals for additional information regarding the enhanced communication capabilities of the M2000 meter. Each manual is available at <a href="http://Badgermeter.com">Badgermeter.com</a> . <ul style="list-style-type: none"> <li>• M2000HART® Bi-Directional Communication Protocol Data Access (MAG-UM-01408-EN-04)</li> <li>• M2000PROFIBUS DP (MAG-UM-01409-EN-04)</li> <li>• M2000MODBUS RTU Communication Daughterboard (MAG-UM-01410-EN-04)</li> </ul>
	<b>External Port Address</b> [1] 	For PROFIBUS® use only. Use External Port Address to configure the PROFIBUS DP daughterboard address.





Communication			
<b>Diagnostics</b>	<b>Port A Counters</b> [0] 	Port counters are used for diagnostics when configured for MODBUS RTU. These counters are only cleared on power up.	
		<b>Counter</b>	<b>Description</b>
		Pkts Processed	Number of packets processed by meter.
		Broadcast Pkts	Number of broadcast packets (address = 0) processed by meter.
		CRC Errors	Number of received packets with CRC error; packet is discarded.
	<b>Port B Counters</b> [0] 	Pkts Rcvd	Number of packets received with an address of the configured port address.
		Pkts Sent	Number of packets transmitted in response to a received packet.
		Parity Errors	Number of characters with parity errors ( <i>for example, if the received character has a mismatch between the number of 1s and its parity bit</i> ); packet is discarded.
		Framing Errors	Number of characters with framing errors ( <i>for example, stop bit is not found – indicates that synchronization with the start bit has been lost and the character is improperly framed</i> ); packet is discarded.
		Overrun Errors	Number of characters received that were not processed due to degradation of system performance.
Break Detects	Number of detections that transmission line is locked ( <i>for example, the receive line is low for 10-bit transmissions following a missing stop bit</i> ).		

Advanced		
<b>Data Logger</b> <b>NOTE:</b> This feature needs an additional memory token that is not included with the standard meter	The Data Logger feature requires firmware version 1.10 or later. Reference Badger Meter P/N 67354-003 to obtain a firmware upgrade kit. See the <i>M2000 Data Logging</i> user manual, available at <a href="http://www.badgermeter.com">www.badgermeter.com</a> , for details on this feature. The Data Logging feature records three types of events to a memory token: <ul style="list-style-type: none"> <li>• Totalizer/error events</li> <li>• Configuration change events</li> <li>• Startup events (power up, power down or reset events)</li> </ul>	
<b>Token Copy</b> <b>NOTE:</b> This feature needs an additional memory token that is not included with the standard meter	<ul style="list-style-type: none"> <li>• Configuration</li> <li>• Store to Token</li> <li>• Restore to Token</li> </ul>	See the <i>M2000 Store/Restore</i> user manual, available at <a href="http://www.badgermeter.com">www.badgermeter.com</a> , for details on using the Token Copy features.
<b>Encoder Protocol</b>	Protocol Type	The Protocol Type enables the encoder interface. Selecting V1 or V2 automatically configures the Digital Input and Digital Output #1 for encoder operation. Manually configuring the input and output for encoder operation is not allowed and results in an error. See <i>“Encoder Protocol Interface” on page 57</i> for further details. V1 – Standard encoder protocol V2 – Enhanced encoder protocol, provides additional digital information Disabled – disables and removes encoder configuration
<b>Totalizer Dials</b>	Set the totalizer dial to 4...10 to select the number of digits for the totalizer to display. For example, setting the dial to 6 causes the totalizer to display six digits (12.3456 USG) <b>NOTE:</b> A totalizer roll over can be indicated by a totalizer alarm via the digital output.	



<b>Advanced</b>																																																																																					
<b>Totalizer Resolution</b> [Off] 	<p>Use Totalizer Resolution to establish the number of units of measure that have to accumulate before the display totalizers are updated. This is also known as setting the number of “dead” zeroes in the display totalizer. For example:</p> <table border="1" style="width: 100%; border-collapse: collapse;"> <thead> <tr> <th colspan="6" style="text-align: center;"><b>Totalizer Resolution less than 1</b></th> </tr> <tr> <th style="width: 15%;">Totalizer Resolution</th> <th colspan="5">Example</th> </tr> </thead> <tbody> <tr> <td>OFF</td> <td>0.00000 USG</td> <td>0.00012 USG</td> <td>0.00123 USG</td> <td>0.01234 USG</td> <td>0.12345 USG</td> </tr> <tr> <td>0.0001</td> <td>0.0000 USG</td> <td>0.0001 USG</td> <td>0.0012 USG</td> <td>0.0123 USG</td> <td>0.1234 USG</td> </tr> <tr> <td>0.001</td> <td>0.000 USG</td> <td>0.000 USG</td> <td>0.001 USG</td> <td>0.012 USG</td> <td>0.123 USG</td> </tr> <tr> <td>0.01</td> <td>0.00 USG</td> <td>0.00 USG</td> <td>0.00 USG</td> <td>0.01 USG</td> <td>0.12 USG</td> </tr> <tr> <td>0.1</td> <td>0.0 USG</td> <td>0.0 USG</td> <td>0.0 USG</td> <td>0.0 USG</td> <td>0.1 USG</td> </tr> </tbody> </table> <table border="1" style="width: 100%; border-collapse: collapse;"> <thead> <tr> <th colspan="6" style="text-align: center;"><b>Totalizer Resolution greater than or equal to 1</b></th> </tr> <tr> <th style="width: 15%;">Totalizer Resolution</th> <th colspan="5">Example</th> </tr> </thead> <tbody> <tr> <td>OFF</td> <td>0.00000 USG</td> <td>1.23456 USG</td> <td>12.34567 USG</td> <td>123.4567 USG</td> <td>1234.456 USG</td> </tr> <tr> <td>1</td> <td>0 USG</td> <td>1 USG</td> <td>12 USG</td> <td>123 USG</td> <td>1234 USG</td> </tr> <tr> <td>10</td> <td>0 USG</td> <td>0 USG</td> <td>10 USG</td> <td>120 USG</td> <td>1230 USG</td> </tr> <tr> <td>100</td> <td>0 USG</td> <td>0 USG</td> <td>0 USG</td> <td>100 USG</td> <td>1200 USG</td> </tr> <tr> <td>1000</td> <td>0 USG</td> <td>0 USG</td> <td>0 USG</td> <td>0 USG</td> <td>1000 USG</td> </tr> </tbody> </table> <p>To change the Totalizer Resolution, follow these steps from the <i>Advanced</i> menu:</p> <ol style="list-style-type: none"> <li>1. Select <b>Totalizer Resolution</b> to view the <i>Totalizer Resolution</i> display.</li> <li>2. Select a resolution.</li> <li>3. Press <b>[E]</b> to save the option and to return to the <i>Advanced</i> menu.</li> </ol>	<b>Totalizer Resolution less than 1</b>						Totalizer Resolution	Example					OFF	0.00000 USG	0.00012 USG	0.00123 USG	0.01234 USG	0.12345 USG	0.0001	0.0000 USG	0.0001 USG	0.0012 USG	0.0123 USG	0.1234 USG	0.001	0.000 USG	0.000 USG	0.001 USG	0.012 USG	0.123 USG	0.01	0.00 USG	0.00 USG	0.00 USG	0.01 USG	0.12 USG	0.1	0.0 USG	0.0 USG	0.0 USG	0.0 USG	0.1 USG	<b>Totalizer Resolution greater than or equal to 1</b>						Totalizer Resolution	Example					OFF	0.00000 USG	1.23456 USG	12.34567 USG	123.4567 USG	1234.456 USG	1	0 USG	1 USG	12 USG	123 USG	1234 USG	10	0 USG	0 USG	10 USG	120 USG	1230 USG	100	0 USG	0 USG	0 USG	100 USG	1200 USG	1000	0 USG	0 USG	0 USG	0 USG	1000 USG
<b>Totalizer Resolution less than 1</b>																																																																																					
Totalizer Resolution	Example																																																																																				
OFF	0.00000 USG	0.00012 USG	0.00123 USG	0.01234 USG	0.12345 USG																																																																																
0.0001	0.0000 USG	0.0001 USG	0.0012 USG	0.0123 USG	0.1234 USG																																																																																
0.001	0.000 USG	0.000 USG	0.001 USG	0.012 USG	0.123 USG																																																																																
0.01	0.00 USG	0.00 USG	0.00 USG	0.01 USG	0.12 USG																																																																																
0.1	0.0 USG	0.0 USG	0.0 USG	0.0 USG	0.1 USG																																																																																
<b>Totalizer Resolution greater than or equal to 1</b>																																																																																					
Totalizer Resolution	Example																																																																																				
OFF	0.00000 USG	1.23456 USG	12.34567 USG	123.4567 USG	1234.456 USG																																																																																
1	0 USG	1 USG	12 USG	123 USG	1234 USG																																																																																
10	0 USG	0 USG	10 USG	120 USG	1230 USG																																																																																
100	0 USG	0 USG	0 USG	100 USG	1200 USG																																																																																
1000	0 USG	0 USG	0 USG	0 USG	1000 USG																																																																																
<b>Backlight Control</b> [Timed Off] 	<p>Use Backlight Control to set the backlight to: Always On, Always Off or Timed Off. When set to Timed Off, the backlight automatically turns off after one minute of inactivity (no buttons pressed). Pressing any button turns the backlight on, but does not immediately navigate the menu.</p> <p>To change Backlight Control, follow these steps from the <i>Advanced</i> menu:</p> <ol style="list-style-type: none"> <li>1. Select <b>Backlight Control</b> to view the <i>Backlight Control</i> display.</li> <li>2. Select an option.</li> <li>3. Press <b>[E]</b> to save the option and to return to the <i>Advanced</i> menu.</li> </ol> <p>Longer operation with the backlight set to “Always On” can reduce LCD lifespan.</p>																																																																																				

<b>Advanced</b>		
<b>Analog Calibrate</b>	<b>Custom Settings</b> [Zero Scale: 0 mA] [Full Scale: 0 mA] 	To set the analog calibration custom settings, follow these steps from the <i>Advanced</i> menu: <ol style="list-style-type: none"> <li>1. Select <b>Analog Calibrate</b> to view the <i>Analog Calibrate</i> menu.</li> <li>2. Select <b>Custom Settings</b> to view the <i>Custom Settings</i> display.</li> <li>3. Select one of the following:               <ul style="list-style-type: none"> <li>• <b>Offset 4 mA</b></li> <li>• <b>Offset 20 mA</b></li> </ul> </li> <li>4. Configure the offset.</li> <li>5. Press [<b>E</b>] to save the option and to return to the <i>Custom Settings</i> menu.</li> <li>6. Press [<b>E</b>] to return to the <i>Analog Calibrate</i> menu.</li> </ol>
	<b>Factory Settings</b> [Factory Set] 	To change the analog calibration factory settings, follow these steps from the <i>Advanced</i> menu: <ol style="list-style-type: none"> <li>1. Select <b>Analog Calibrate</b> to view the <i>Analog Calibrate</i> menu.</li> <li>2. Select <b>Factory Settings</b> to view the <i>Factory Settings</i> display.</li> <li>3. Select one of the following:               <ul style="list-style-type: none"> <li>• <b>Calibration Point A</b></li> <li>• <b>Calibration Point B</b></li> </ul> </li> <li>4. Set the calibration point to the measured output current.</li> <li>5. Press [<b>E</b>] to save the option and to return to the <i>Factory Settings</i> menu.</li> <li>6. Press [<b>E</b>] to return to the <i>Analog Calibrate</i> menu.</li> </ol>
<b>Software Filter</b> <b>MDN-Filter</b>	<b>Description</b>	This software filter operates as a median filter. This filter is very responsive and can be used to help stabilize flow measurements. It is enabled by selecting a non-zero filter size. Supported filter sizes are: <ul style="list-style-type: none"> <li>• S0 - Size 0</li> <li>• S5 - Size 5</li> <li>• S7 - Size 7</li> <li>• S9 - Size 9</li> </ul> The filter technique uses the median value of the last Sx samples used for determining flow measurement.

<b>Advanced</b>		
<b>Software Filter ACC-Filter</b>	<b>Description</b>	This software filter operates as an acceleration filter. This filter, when configured properly, allows for filtering of fast changes in fluid flow. Generally, this filter is used in applications having highly conductive fluids. It is intended to help provide smoothing of the analog output and display fluctuations.
	<b>Activation</b> [Off] 	Use Activation to enable or disable the software acceleration filter. To change the Activation setting, follow these steps from the <i>Advanced</i> menu: <ol style="list-style-type: none"> <li>1. Select <b>Activation</b> from the <i>Advanced</i> menu.</li> <li>2. Select a setting.</li> <li>3. Press [E] to save the option and to return to the <i>Advanced</i> menu.</li> </ol>
	<b>Filter Delay</b> [1] 	Use Filter Delay to set the amount of time that the flow is held constant once the filter is activated. The filter is activated by an acceleration component of the fluid exceeding the configured limit. To change the Filter Delay follow these steps from the <i>Advanced</i> menu: <ol style="list-style-type: none"> <li>1. Select <b>Filter Delay</b> from the <i>Advanced</i> menu.</li> <li>2. Enter the setting.</li> <li>3. Press [E] to save the option and to return to the <i>Advanced</i> menu.</li> </ol>
	<b>Acceleration Factor</b> [1] 	Use Acceleration Factor to set the maximum acceleration for a given pipe diameter. It is dependent on the excitation frequency. The maximum fluid velocity is 12 m/s. The following equation defines the maximum fluid acceleration: $\text{Acceleration(MAX)} = \text{Acceleration Factor} * 12 \text{ m/s} * \text{Pipe Area} * \text{Excitation Frequency}/1.5$ If the realized fluid acceleration exceeds the configured maximum acceleration, fluid flow is held constant for the time set at the Filter Delay parameter. To change the Acceleration Factor setting, follow these steps from the <i>Advanced</i> menu: <ol style="list-style-type: none"> <li>1. Select <b>Acceleration Factor</b> from the <i>Advanced</i> menu.</li> <li>2. Enter the setting.</li> <li>3. Press [E] to save the option and to return to the <i>Advanced</i> menu.</li> </ol>
	<b>Constant Flow</b> [150 M <sup>3</sup> /Sec <sup>2</sup> ] 	During normal flow conditions, there is always a non-zero acceleration component. For example, if acceleration of the flow activates the filter, the meter assumes constant flow for the duration of the filter delay time unless the flow returns within limits. Properly configured, this parameter helps offset excessive impacts of the filter delay. The Constant Flow parameter lets you set the acceleration limit for constant flow. To change the Constant Flow setting, follow these steps from the <i>Advanced</i> menu: <ol style="list-style-type: none"> <li>1. Select <b>Constant Flow</b> from the <i>Advanced</i> menu.</li> <li>2. Enter the setting.</li> <li>3. Press [E] to save the option and to return to the <i>Advanced</i> menu.</li> </ol>

<b>Advanced</b>		
<b>Software Filter ACC-Filter (continued)</b>	<b>Peak Detect</b> [0 M <sup>3</sup> /Sec <sup>2</sup> ] 	Peak Detect offers a diagnostic view of the acceleration components observed during flow conditions. This parameter records the “high water mark” of the measured accelerations component. This value helps to properly configure the Acceleration Factor parameter. Generally, you set the acceleration factor at about 75% of the Peak Detect measurement. To reset the Peak Detect setting, follow these steps from the <i>Advanced</i> menu: <ol style="list-style-type: none"> <li>1. Select <b>Peak Detect</b> from the <i>Advanced</i> menu.</li> <li>2. Press [+] to reset.</li> <li>3. Press [E] to return to the <i>Advanced</i> menu.</li> </ol>
<b>Software Filter ZFS-Filter</b>	<b>Description</b>	This software filter operates as a zero-flow stability filter. A specific volume is defined for a specific time window. If that volume is not measured during the time window, this volume is ignored and not totalized. The actual flow can be monitored with the status function. Filter options are: <ul style="list-style-type: none"> <li>• Volume USG</li> <li>• Time</li> <li>• Status (shows Volume and Time)</li> </ul>
<b>Software Filter IIR-Filter</b>	<b>Description</b>	This software filter operates as an infinite impulse response filter, used to help suppress erratic flow measurements. Contact Badger Meter Technical Support.
	<b>Activation</b>	ON/OFF
	<b>Coefficient Min</b>	Numeric entry
	<b>Coefficient Max</b>	Numeric entry
	<b>Coefficient Status</b>	Numeric entry
	<b>Sensitivity</b>	Numeric entry
	<b>Hysteresis</b>	m/s

### Advanced

#### Empty Pipe Cal.

[Default]



Fluid conductivity impacts the performance of empty pipe measurements. If you require empty pipe detection, you should perform this empty pipe calibration procedure. Before starting the empty pipe calibration, verify that empty pipe detection is enabled. Also, run both the empty pipe and the full pipe calibration procedures.

#### Calibrating an Empty Pipe

Before calibrating an empty pipe, verify that the pipe is empty.

To calibrate with an empty pipe, follow these steps from the *Advanced* menu:

1. Select **Empty Pipe Cal** to view the *Calibration* menus.
2. Select **Cal. Empty Pipe** to view the *Empty Pipe Calibrate* menu.
3. To enable calibration, place the cursor on the calibration enable line and press [E].

```
EMPTY PIPE CALIBRATE
Volts = 3.00
>Cal [ON]      E=OFF
Exit with Save
```

4. Wait 30 seconds for voltage measurement to stabilize.
5. To save the setting, place the cursor on **Exit with Save** and press [E].

#### Calibrating a Full Pipe



Before calibrating a full pipe, verify that the pipe is full.





To calibrate with a full pipe, follow these steps from the *Advanced* menu:

1. Select **Empty Pipe Cal** to view the *Calibration* menus.
2. Select **Cal. Full Pipe** to view the *Full Pipe Calibrate* menu.
3. Enable calibration by placing the cursor on the calibration enable line and press [E].

```
FULL PIPE CALIBRATE
Volts = 1.515
>Cal [OFF]     E=ON
Exit with Save
```

4. Wait 30 seconds for voltage measurement to stabilize.
5. To save the setting, place the cursor on **Exit with Save** and press [E].

<b>Advanced</b>		
<b>Security</b>	<b>Set Admin PIN</b> [00000] 	Users logged in with this PIN have access to all M2000 meter procedures. To set the administrator's PIN, follow these steps from the <i>Advanced</i> Menu: <ol style="list-style-type: none"> <li>1. Select <b>Security</b> to view the <i>Security</i> menu.</li> <li>2. Select <b>Set Admin PIN</b> to view the <i>Admin PIN</i> display.</li> <li>3. Set the five-digit PIN number to a value.</li> <li>4. Press [<b>E</b>] to save the PIN and to return to the <i>Security</i> menu.</li> </ol>
	<b>Set Service PIN</b> [00000] 	Users logged in with this PIN have access to all service level and user-level procedures. Service users do not have access to administrative procedures. To set the service PIN, follow these steps from the <i>Advanced</i> Menu: <ol style="list-style-type: none"> <li>1. Select <b>Security</b> to view the <i>Security</i> menu.</li> <li>2. Select <b>Set Service PIN</b> to view the <i>Service PIN</i> display.</li> <li>3. Set the five-digit PIN number to a value.</li> <li>4. Press [<b>E</b>] to save the PIN and to return to the <i>Security</i> menu.</li> </ol>
	<b>Set User PIN</b> [00000] 	Users logged in with this PIN have access to user-level procedures. Users at this level do not have access to administrative or service procedures. To set the user's PIN, follow these steps from the <i>Advanced</i> Menu: <ol style="list-style-type: none"> <li>1. Select <b>Security</b> to view the <i>Security</i> menu.</li> <li>2. Select <b>Set User PIN</b> to view the <i>User PIN</i> display.</li> <li>3. Set the five-digit PIN number to a value.</li> <li>4. Press [<b>E</b>] to save the PIN and to return to the <i>Security</i> menu.</li> </ol>

<b>Info/Help</b>		
<b>Error Counts</b> [0] 	<b>Description</b>	This menu provides a diagnostic view of meter performance. Below are several system diagnostic counters and their definitions. Use discretion when interpreting these counters. These values could be altered during system setup or when using the verification device. We suggest that you reset these counters before you start monitoring your system and look for conditions possibly affecting performance.
	<b>Sensor</b>	The number of times an invalid sensor condition has been observed.
	<b>Empty Pipe</b>	The number of times an empty pipe condition has been observed by the meter.
	<b>Full Scale</b>	The number of times the flow has exceeded the Full Scale Flow setting.
	<b>Totalizer</b>	The number of times the totalizers have exceeded limits of the meter.
	<b>Pulse Sync.</b>	The number of times the pulse outputs have fallen out of synchronization.
	<b>ADC Interrupt</b>	The number of times an analog input measurement has been missed.
	<b>ADC Range</b>	The number of times the analog input measurement range has been exceeded.
	<b>System Error</b>	A diagnostic system message indicating the reason for a system reset.
	<b>System Resets</b>	The number of times the meter has been reset.
	<b>System Reset ID</b>	Diagnostic information about a system reset as a result of expired internal timers.
<b>Token Errors</b>	Indicates the number of parameter copies from a memory token that failed to be copied to the meter.	
<b>Checksum</b>	For MID meters. If data corruption to the meter memory occurs, this “counter” indicates the memory region that is corrupted.	
<b>PowerUp Counter</b> [Not applicable] 	The number of times that the unit has been powered on.	
<b>Power Off Totalizer</b> [Not applicable] 	The length of time that the unit has been without power.	
<b>Version Info</b> [Not applicable] 	The current software version.	
<b>Serial Number</b> [Not applicable] 	The manufacturing serial number in the format YYMM####, where YYMM indicates year and month of manufacturing and #### indicates the sequence number.	
<b>Meter Tag Name</b>	For PROFIBUS – This parameter is only programmable over external PROFIBUS communications.	
<b>Daughterboard Information</b>	Describes current version of attached daughterboard. <b>NOTE:</b> RS485 daughterboard is not recognized because it is a pass-through device rather than an intelligent protocol converter like Hart-to-MODBUS.	
<b>Polarization Voltage</b>	Diagnostic voltage to help determine if the meter or application is performing optimally.	

<b>Info/Help</b>	
<b>Restore Defaults</b> [Not applicable] 	Use Restore Defaults to restore all non-calibrated parameters to the factory defaults.

<b>Language Select</b>	
<b>Language Select</b> [English] 	The meter supports one alternate language along with English. This alternate language choice is set at the factory. The options are: Spanish, German, Czech or French. To select the language, follow these steps from the <b>Language Select menu</b> : <ol style="list-style-type: none"><li>1. Select a language.</li><li>2. Press [<b>E</b>] to save the selection.</li></ol>



## ENCODER PROTOCOL INTERFACE

The encoder protocol interface requires firmware version 1.10 or later. Reference Badger Meter P/N 67354-003 to obtain a firmware upgrade kit.

Enabling the meter as an encoder requires three settings, all within the advanced menu, to be configured.

- Totalizer Resolution – Selects the resolution of the display totalizer.
- Protocol Type – Selects the type of information to be transmitted to the encoder.
- Dial Type – Enables encoder and selects the number of significant totalizer digits to transmit.

Changing the protocol type automatically configures the necessary digital inputs/outputs. Manually changing the digital inputs/outputs within the *Input/Outputs* menu is not allowed. Below is a wiring diagram for connecting an encoder to the meter.

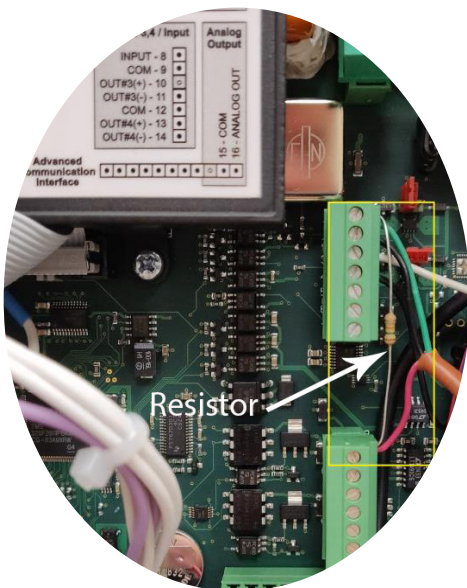

Encoder Connections

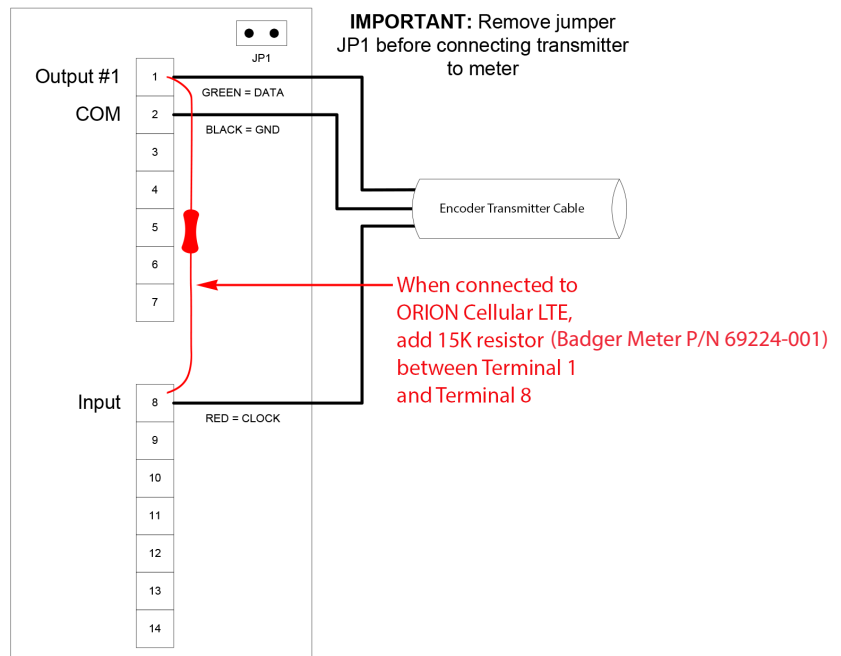

Figure 38: Encoder interface

**NOTE:** When connected to an ORION® Cellular LTE endpoint, add a 15K resistor (Badger Meter P/N 69224-001) to the meter terminal block between terminal 1 (green wire) and terminal 8 (red wire) as shown to correct any potential meter reading issues. The resistor is indicated by an arrow in the photo and in the drawing.

The following table demonstrates how the totalizers are displayed under various configurations of the Totalizer Resolution (that is, resolution) and Dial Type. The non-shaded digits are transmitted as defined by the dial type.

For example, if the dial type is 4-dial and the resolution is 10000 then an arbitrary totalizer value of 99999999 is displayed on the meter as 99990000 and 9999 is transmitted to the receiving application. In this configuration it takes 10000 units (for example, USG) before the display totalizer is updated to a new value. For this example the display totalizer rolls over to 00000000.

Dial Type	Totalizer Resolution	Display Digits									
		1	2	3	4	5	6	7	8	9	0
4 dial	10000			1	2	3	4	0	0	0	0
	1000				1	2	3	4	0	0	0
	100					1	2	3	4	0	0
	10						1	2	3	4	0
	1							1	2	3	4
	0.1							1	2	3	.
	0.01							1	2	.	3
	0.001							1	.	2	3
5 dial	10000		1	2	3	4	5	0	0	0	0
	1000			1	2	3	4	5	0	0	0
	100				1	2	3	4	5	0	0
	10					1	2	3	4	5	0
	1						1	2	3	4	5
	0.1						1	2	3	4	.
	0.01						1	2	3	.	4
	0.001						1	2	.	3	4
6 dial	10000	1	2	3	4	5	6	0	0	0	0
	1000		1	2	3	4	5	6	0	0	0
	100			1	2	3	4	5	6	0	0
	10				1	2	3	4	5	6	0
	1					1	2	3	4	5	6
	0.1					1	2	3	4	5	.
	0.01					1	2	3	4	.	5
	0.001					1	2	3	.	4	5
7 dial	10000	Not Applicable – Not enough display digits									
	1000	1	2	3	4	5	6	7	0	0	0
	100		1	2	3	4	5	6	7	0	0
	10			1	2	3	4	5	6	7	0
	1				1	2	3	4	5	6	7
	0.1				1	2	3	4	5	6	.
	0.01				1	2	3	4	5	.	6
	0.001				1	2	3	4	.	5	6
8 dial	10000	Not Applicable – Not enough display digits									
	1000	Not Applicable – Not enough display digits									
	100	1	2	3	4	5	6	7	8	0	0
	10		1	2	3	4	5	6	7	8	0
	1			1	2	3	4	5	6	7	8
	0.1			1	2	3	4	5	6	7	.
	0.01			1	2	3	4	5	6	.	7
	0.001			1	2	3	4	5	.	6	7

Dial Type	Totalizer Resolution	Display Digits									
		1	2	3	4	5	6	7	8	9	0
9 dial	10000	Not Applicable– Not enough display digits									
	1000	Not Applicable– Not enough display digits									
	100	Not Applicable– Not enough display digits									
	10	1	2	3	4	5	6	7	8	9	0
	1		1	2	3	4	5	6	7	8	9
	0.1	1	2	3	4	5	6	7	8	.	9
	0.01	1	2	3	4	5	6	7	.	8	9
	0.001	1	2	3	4	5	6	.	7	8	9
0.0001	1	2	3	4	5	.	6	7	8	9	
10 dial*	10000	Not Applicable– Not enough display digits									
	1000	Not Applicable– Not enough display digits									
	100	Not Applicable– Not enough display digits									
	10	Not Applicable– Not enough display digits									
	1	1	2	3	4	5	6	7	8	9	0
	0.1	1	2	3	4	5	6	7	8	9	.0
	0.01	1	2	3	4	5	6	7	8	.9	0
	0.001	1	2	3	4	5	6	7	.8	9	0
0.0001	1	2	3	4	5	6	.7	8	9	0	

\*10 dial reading is not supported by the encoder protocol. When the meter is configured, the display settings for number of dials and resolution are based on what the encoder protocol can support. For example, if the encoder output is enabled (V1 or V2) and you try to select 10 dials, the display shows an error dialog since this is an invalid configuration for the encoder. If the encoder output is not enabled, a selection of up to 10 digits is available.

## IMPORTANT

The totalizers are represented in a manner equivalent to an actual encoder. For example, 1 USG on a 4 dial is transmitted/displayed as "0001". If in bidirectional mode, -1 USG is transmitted/displayed as "9999".

The protocol type has two options:

- V1 – meter provides single totalizer, Tn (bidirectional) or T1 (unidirectional)
- V2 – meter provides extended information (For ORION Cellular, ORION Fixed Network (SE) or ORION Migratable (ME))

The additional information provided by protocol type V2 is only accessible for specific models of the encoder (for example, ORION SE or ORION ME). The additional information of protocol type V2 includes status information of the meter, meter identification, a second totalizer reading (T+ or T2), relative flow rate (0...100%) and flow direction.

## Store/Restore Feature

The Store/Restore feature is intended to save installation costs and reduce installation time. This feature is also intended to protect meter configuration and assure the operator that the meter is properly configured. Over time and handling of the meter, the meter configuration could change. The Store/Restore feature allows the meter to be quickly set to the operator's original configuration. Refer to the *M2000 Store/Restore* user manual for details on this feature.

## Data Logging Feature

The Data Logging feature records three types of events to a memory token:

- Totalizer/error events
- Configuration change events
- Startup events (power up, power down or reset events)

Each type of event is recorded into three separate files stored on the memory token. These files are extracted using the provided flow meter tool software over the RS232 communication link. Refer to the *M2000 Data Logging* user manual for details on this feature.

## MAINTENANCE

Mandatory, routine or scheduled maintenance should not be required for the M2000 meter electronics or flow tube after proper installation.

However, some instances may require you to perform the following:

- Flow tube and electrode cleaning
- Fuse replacement
- Circuit board replacement

### **⚠ WARNING**

- **DISCONNECT MAIN POWER TO THE UNIT BEFORE ATTEMPTING ANY DEVICE MAINTENANCE OR CLEANING.**
- **DO NOT CLEAN COMPONENTS INSIDE THE AMPLIFIER OR JUNCTION BOX.**
- **CLEAN USING A DAMP CLOTH. DO NOT USE LIQUID OR AEROSOL CLEANERS.**

### Cleaning the Flow Tube and Electrode

At times flow tube, electrodes, transmitter/junction box housings and the transmitter window may need periodic cleaning, depending on process fluid properties, fluid flow rate and surrounding environment.

Clean the flow tube and electrodes by following the material handling and cleaning procedures documented in Material Safety Data Sheet (MSDS) guidelines for the product(s) that were in contact with the flow tube and electrodes.

Should flow tube and/or electrode cleaning become necessary:

1. Disconnect sensor from pipeline.
2. Clean electrodes according to MSDS guidelines.
3. Reconnect sensor to pipeline.

### Replacing the Circuit Board

Refer to the *M2000 Interchangeability Procedure Application Brief* for information on replacing circuit boards.

### Replacing the Fuse

#### **⚠ WARNING**

**DISCONNECT MAIN POWER TO THE UNIT BEFORE ATTEMPTING ANY DEVICE MAINTENANCE. RISK OF ELECTRICAL SHOCK. REPLACE THE FUSE ONLY WITH 250V AC, 2 AMP, SLOW BLOW (5 × 20 MM). AUTHORIZED PERSONNEL MUST REPLACE FUSES.**

Fuse type: T2 H 250 V (2A idle)

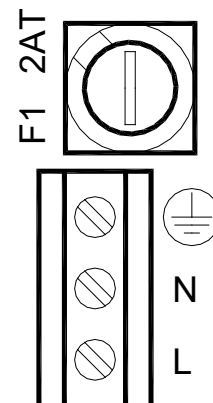

Figure 39: Fuse

BA14MID

## TROUBLESHOOTING

The meter is designed for many years of optimal performance. However, should it malfunction, there are certain things that we recommend you check before contacting our Technical Support department or your local Badger Meter Representative. If the fluid measured has a high concentration of conductive solids, deposits may accumulate on the internal liner walls and electrodes. These deposits cause a reduction of the measuring output. Thus, Badger Meter recommends that you remove the meter and inspect the liner and electrodes after six months. If deposits are found, remove them with a soft brush. Repeat inspection process every six months or until an appropriate inspection cycle can be established for the specific application.

Description	Possible Cause	Recommended Action
Rollover warning	<ul style="list-style-type: none"> <li>A rollover warning occurs when the display totalizer can no longer represent the current value within the totalizer. A rollover warning is dependent on the number of dials, resolution and the unit of measure.</li> </ul>	<ul style="list-style-type: none"> <li>Increase number of dials</li> <li>Reduce resolution or</li> <li>Clear totalizers</li> </ul>
Flow is present but display is "0"	<ul style="list-style-type: none"> <li>Digital input is holding flow.</li> <li>Disconnected signal cable.</li> <li>Sensor mounted opposite of the main flow direction (see arrow on the nameplate).</li> <li>Coil or electrode cables exchanged.</li> <li>Improper low flow cutoff or Full Scale Flow.</li> </ul>	<ul style="list-style-type: none"> <li>Verify digital input configuration.</li> <li>Check signal cable.</li> <li>Turn sensor by 180° or switch terminal E1 and E2 or reprogram to bidirectional mode.</li> <li>Check cable connections for cross wiring.</li> <li>Replace configuration defaults.</li> </ul>
Inaccurate measuring	<ul style="list-style-type: none"> <li>Improper calibration.</li> <li>Wrong calibration parameter.</li> <li>Pipe not fully filled, or air in pipe.</li> <li>Invalid fluid conductivity.</li> <li>Invalid fluid mixture.</li> </ul>	<ul style="list-style-type: none"> <li>Restore calibration defaults.</li> <li>Check the parameters (sensor factor and size) according to supplied data sheet.</li> <li>Check if meter is completely filled with fluid.</li> <li>Purge line to eliminate air bubbles.</li> </ul>
No display	<ul style="list-style-type: none"> <li>No power.</li> <li>Incorrect power.</li> <li>Blown fuse.</li> <li>Bad wiring connections.</li> </ul>	<ul style="list-style-type: none"> <li>Apply power.</li> <li>Check power value.</li> <li>Replace fuse (2 amp, 250V AC, slow blow 5 × 20 mm).</li> <li>Check display ribbon cable.</li> </ul>
Flow rate value known to be wrong	<ul style="list-style-type: none"> <li>Sensor factor.</li> <li>Deposits on electrodes and/or liner.</li> <li>Incorrect pipe size programmed.</li> </ul>	<ul style="list-style-type: none"> <li>Check value on label.</li> <li>Check and remove deposits.</li> <li>Check size if necessary.</li> </ul>
Flow rate indication unstable	<ul style="list-style-type: none"> <li>Cable issue.</li> <li>Grounding issue.</li> <li>Partially full pipe.</li> <li>Air in pipe.</li> <li>Transmitter location – outside electrical.</li> <li>Invalid fluid conductivity.</li> </ul>	<ul style="list-style-type: none"> <li>Make sure cable is shielded and not vibrating.</li> <li>Make sure meter is properly grounded to a good earth ground.</li> <li>Make sure pipe is full of fluid.</li> <li>Make sure fluid does not contain air bubbles.</li> <li>Make sure transmitter is not too close to sources of electrical interference.</li> </ul>
BEACON AMA displays multiple estimated flow occurrences for meters connected to ORION Cellular LTE endpoints.	<ul style="list-style-type: none"> <li>ORION Cellular LTE endpoints require additional resistance.</li> </ul>	<ul style="list-style-type: none"> <li>Add a 15K resistor to the M2000 meter terminal block. See <a href="#">"Encoder Protocol Interface" on page 57</a> for complete details.</li> </ul>

<b>Menu Manager Configuration Errors</b>		
<b>Error</b>	<b>Description</b>	<b>Recommended Action</b>
100	<b>ADE®: Configuration of the ADE interface is invalid.</b>	<p>This error is displayed when an invalid modification to any of the following menu parameters is detected: Protocol Type, Dial Type, Totalizer Resolution, Digital Input Function Type or Digital Output Function Type.</p> <ol style="list-style-type: none"> <li>1. Configuring the meter as an ADE interface has the following limitations: Protocol Type V1 is only allowed if number of dials is less than 8.</li> <li>2. The Totalizer Resolution must be set to something other than OFF.</li> <li>3. For 8 dial configuration, a resolution of 10000 and 1000 are not supported. There are not enough display digits to accommodate 8 dials and greater than 100 units of resolution.</li> <li>4. For 7 dial configuration, a resolution of 10000 is not supported. There are not enough display digits to accommodate 7 dials and greater than 1000 units of resolution.</li> </ol>
101	<b>ADE: Enabling/Disabling ADE operation is invalid</b>	<p>This error is observed when Digital input or output function is manually selected for ADE operation. Enabling or Disabling ADE operation can only be accomplished by setting the ADE protocol type.</p>
110	<b>Output 1/2: Pulse Output Configuration Error</b>	<p>This error is observed when improperly configuring either the Full Scale Flow, pulse per unit, pulse width or digital output function type for pulse output operation. Preparing these parameters for pulse output operation (forward or reverse) has limitations that are monitored by the menu manager.</p> <p>This error can indicate the following configuration violations:</p> <ul style="list-style-type: none"> <li>• Pulse Frequency exceeds limits at Full Scale Flow</li> <li>• Pulse duty cycle is less than 50% at Full Scale Flow (pulse on time &gt; pulse off time)</li> <li>• AMR Pulse Frequency exceeds limit at Full Scale Flow</li> </ul> <p>The pulse frequency limit is 10 kHz when the pulse width is 0 (50% duty cycle). The pulse frequency limit is <math>1/(2 * \text{Pulse Width})</math> when the pulse width is non-zero in order to achieve a 50% duty cycle. For AMR operation, the frequency limit is 3 HZ.</p> <p>Follow these steps for configuring meter for pulse output operation:</p> <ol style="list-style-type: none"> <li>1. Set PPU to zero for both output 1 and 2.</li> <li>2. If necessary, set Full Scale Flow appropriately for application.</li> <li>3. Set PW as required by the equipment receiving pulse transmissions from the meter. Observe frequency limits for non-zero pulse widths.</li> <li>4. Determine the needed pulse frequency at a typical flow rate (<i>for example</i>, 1000 HZ @ 250 GPM).</li> <li>5. Calculate ratio of typical flow rate to Full Scale Flow: ratio = typical flow rate/Full Scale Flow (<i>for example</i>, 250 GPM/500 GPM = 0.5).</li> <li>6. Calculate flow rate conversion factor: For GPM, conversion factor = 1/60, for GPH, conversion factor = 1/3600, for GPS, conversion factor = 1.</li> <li>7. Calculate PPU: <math>\text{PPU} = (\text{Needed pulse frequency at typical flow rate}/\text{ratio})/[\text{Full Scale Flow} * (\text{conversion factor})]</math> = <math>(1000/0.5)/[500 * (1/60)]</math> = 240 Pulse/Gallon.</li> <li>8. If you receive an error consider reducing value of Full Scale Flow and making sure pulse frequency is within limits. Then redo steps 4...7.</li> </ol> <p>If not using the pulse outputs, set the pulses per unit to zero to allow for re-configuration of the Full Scale Flow. If required to use the pulse outputs, re-evaluate the pulse output configuration. Consider recording and clearing totalizers following pulse output configuration.</p>
120	<b>Display: Totalizer Conversion Error – Totalizer cannot be properly converted for display</b>	<p>This error is observed while trying to change the totalizer units. Limits of display prevent improper configuration of the volume unit dependent on current totalizer values. Consider recording and cleaning totalizers prior to changing totalizer.</p>
121	<b>Output 1/2: Pulse Output Configuration Error</b>	<p>This error is observed when changing the totalizer units of measure. This error implies the pulse configuration exceeds limits (see error <b>110</b>). Please note the pulses per unit are not automatically updated on volume unit re-configuration. The pulses per unit should be manually changed to accommodate the units of measure. It may be necessary to set the pulses per unit to zero, then change the totalizer units.</p>
140	<b>Output 3: Configuration Error – Full scale frequency exceeds limits of relay (1000 Hz)</b>	<p>Reduce full scale frequency output setting when hardware is configured for relay operation.</p>
150	<b>Output 3: Configuration Error – Full scale frequency exceeds limits (10 kHz)</b>	<p>Reduce full scale frequency output setting when hardware is configured for open collector operation.</p>
170	<b>Output 1/2: Output Type Configuration Error</b>	<p>This error is observed when the function type is 24V DC and the output type is changed from Normally Open to Normally Closed. Normally Open output type is required for 24V DC output operation.</p>
171	<b>Output 1/2: Output Type Configuration Error</b>	<p>This error is observed when the function type is ADE and the output type is changed from Normally Open to Normally Closed. Normally Open output type is required for ADE operation.</p>
190	<b>Full Scale Flow: Entered Value exceeds limits</b>	<p>Value entered exceeds the absolute maximum flow the meter supports. Reduce the value for this parameter or consider increasing pipe diameter.</p>

Display Error/Status Messages		
Error Message	Possible Cause	Recommended Action
Err: Sensor	No sensor connection with transmitter.	Check sensor and cable connections in accordance with this manual.
	Connection between transmitter and sensor.	Contact Technical Support.
	Supply voltage too low.	Contact Technical Support.
	Grounded coils in meter.	Contact Technical Support.
	Water in sensor.	Contact Technical Support.
Err: Empty pipe	Pipe may not be full.	Make sure all trapped air is out of system. If fluid or fluid conductivity, recalibrate the parameter.
Err: Full scale	Actual flow rate is exceeding programmed flow.	Reduce flow rate or increase the programmed full scale value by more than 5%.
Err: AD-Range	AD-Converter is exceeding signal limits.	Check the grounding scheme of the meter installation. See grounding section in this manual. Verify pipe is not empty.
Err: AD-INT	Initialization of AD-Converter unsuccessful.	Contact Technical Support.
Err: Rollover	Rollover counters have exceeded limit.	Clear all totalizers.
Err: Rollover Status	Totalizer rollover has occurred.	Reload totalizer then clear all totalizers.
Err: Simulation	I/O simulator is enabled.	Disable simulator in I/O menu.
Err: Coil	Meter not connected. Connection to meter interrupted. Sensor electronics or coils defective.	Check if meter is connected and make sure that cable connection is not interrupted. Contact Technical Support if not resolved.
Wrn: Pulse Sync	False synchronization of pulse output.	—
Err: ADC range	Input signal from sensor too high.	Check the grounding scheme of the meter installation. See <a href="#">“Meter Grounding and Potential Equalization” on page 15</a> for instructions.

### Repair of Faults

Disconnect all units from power supply and have it repaired by a qualified service person if any of the following occurs:

- The power cord or plug is damaged or frayed.
- The unit does not operate normally when operating instructions are followed.
- The unit was exposed to rain/water or a liquid has been spilled into it.
- The unit has been dropped or damaged.
- The unit shows a change in performance, indicating a need for service.

## SPECIFICATIONS

**NOTE:** DN represents nominal diameter in mm.

### Transmitter Specifications

<b>Flow Range</b>	0.10...39.4 ft/s (0.03...12 m/s)		
<b>Accuracy</b>	± 0.20% m.v. ± 1 mm/s OI ML/MID: 2...12 in. (DN50...300) with 0d up and 0d downstream ±1% ≥ 0.5 ft/s (0.15 m/s)		
<b>Repeatability</b>	± 0.1%		
<b>Power Supply</b>	<b>AC Power Supply:</b> 85...265V AC; Typical Power: 20V A or 15W; Maximum Power: 26V A or 20W <b>Optional DC Power Supply:</b> 10...36V DC; Typical Power: 10W; Maximum Power: 14W		
<b>Analog Output</b>	4...20 mA, 0...20 mA, 0...10 mA, 2...10 mA (programmable and scalable) Voltage sourced 24V DC isolated. Maximum loop resistance < 800 ohms.		
<b>Digital Output</b>	Four total, configurable 24V DC sourcing active output (up to 2), 100 mA total, 50 mA each; sinking open collector output (up to four), 30V DC max, 100 mA each; AC solid-state relay (up to 2), 48V AC, 500 mA max		
<b>Digital Input</b>	Max 30V DC (programmable – positive zero return, external totalizer reset or preset batch start)		
<b>Frequency Output</b>	Scalable up to 10 kHz, open collector up to 1 kHz, solid-state relay		
<b>Misc Output</b>	High/low flow alarm (0...100% of flow), error alarm, empty pipe alarm, flow direction, preset batch alarm, 24V DC supply, ADE		
<b>Communication</b>	RS232 Modbus RTU; RS485 Modbus RTU, HART, Profibus DP require separate daughterboards		
<b>Pulse Width</b>	Scalable up to 10 kHz, passive open collector up to 10 kHz, active switched 24V DC. Up to two outputs (forward and reverse). Pulse width programmable from 1...1000 ms or 50% duty cycle.		
<b>Processing</b>	32-bit DSP		
<b>Empty Pipe Detection</b>	Field tunable for optimum performance based on specific application		
<b>Excitation Frequency</b>	1 Hz, 3.75 Hz, 7.5 Hz or 15 Hz (factory optimized to pipe diameter)		
<b>Noise Dampening</b>	Programmable 0...30 seconds		
<b>Low Flow Cut-Off</b>	Programmable 0...10% of maximum flow		
<b>Galvanic Separation</b>	250V		
<b>Fluid Conductivity</b>	Minimum 5.0 µS/cm (minimum 20 µS/cm for demineralized water)		
<b>Fluid Temperature</b>	<b>With Remote Transmitter:</b> PFA, PTFE and Halar 302° F (150° C) <b>With Meter-Mounted Transmitter:</b> Rubber 178° F, (80° C), PFA, PTFE and Halar 212° F (100° C)		
<b>Ambient Temperature</b>	– 4...140° F (–20...60° C)		
<b>Relative Humidity</b>	Up to 90 percent non-condensing		
<b>Flow Direction</b>	Unidirectional or bidirectional two separate totalizers (programmable)		
<b>Totalization</b>	Programmable/resettable		
<b>Units of Measure</b>	Ounce, pound, liter, US gallon, imperial gallon, barrel, hectoliter, mega gallon, cubic meter, cubic feet, acre feet		
<b>Display</b>	4 × 20 character display with backlight		
<b>Programming</b>	Three-button, external manual or remote		
<b>Transmitter Housing</b>	Cast aluminum, powder-coated paint		
<b>Mounting</b>	Meter mount or remote wall mount (bracket supplied)		
<b>Locations</b>	Indoor and outdoor		
<b>Meter Enclosure Classification</b>	<b>Standard:</b> NEMA 4X (IP67); <b>Optional:</b> Submersible IP68, remote transmitter required		
<b>Junction Box Enclosure Protection</b>	For remote transmitter option: powder-coated die-cast aluminum, NEMA 4X (IP67)		
<b>Cable Entries</b>	M20 cable glands (3)		
<b>Optional Stainless Steel Grounding Rings</b>	<b>Meter Size</b>	<b>Thickness of one ring</b>	<b>Thickness of one ring (DIN Flanges)</b>
	Up through 10 in.	0.135 in. (3.429 mm)	0.12 in. (3 mm)
	12...78 in.	0.187 in. (4.750 mm)	0.12 in. (3 mm)
<b>NSF/ANSI/CAN 61 and 372 Listed</b>	Models with hard rubber liner, 4 in. size and larger; PTFE liner, all sizes		
<b>OI ML R49-1 MID MI-001</b>	Size range: DN50...300 / 2...12 in. Minimum straight inlet flow: 0 DN /outlet flow: 0 DN Forward and reverse (bi-directional) flow on any orientation Ratio (Q3/Q1) up to 250 Accuracy Class 1		
<b>Token Features</b>	Data Logging (Blue token); Store/Restore (Red token); Firmware Upgrade (Black token)		



**M2000 Transmitter Dimensions  
in. (mm)**

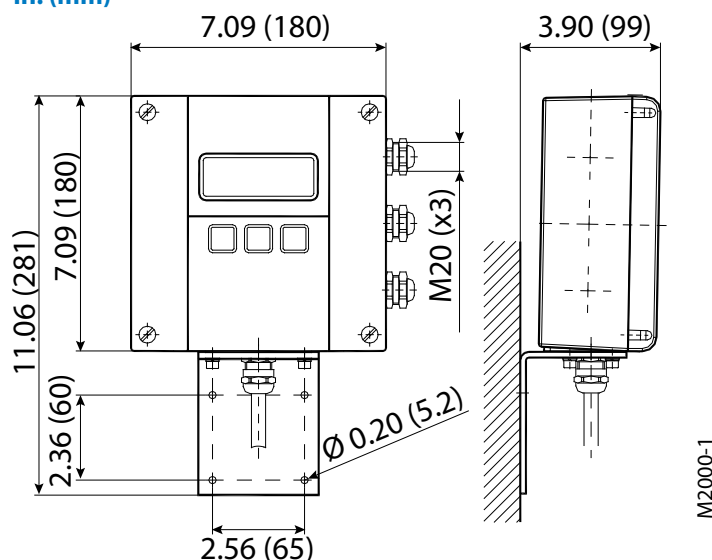

**Sensor Type II Specifications**

The electromagnetic sensor type II is not only available in a number of different flange process connections (DIN, ANSI, JIS, AWWA, and more) but also in a number of liners like hard rubber, PTFE, PFA, or Halar. The sensor is configurable with up to 4 electrodes for measuring, empty pipe and grounding electrodes. Available in sizes from DN 6 TO DN 2000 and nominal pressures up to PN 100, the sensor type II is best suited for a variety of applications in the industry and the water/waste water industry.

<b>Size</b>	1/4...78 in. (DN 6...2000)	
<b>Flanges</b>	ANSI B16.5, AWWA, ISO 1092-1, JIS and more in carbon steel. Optional 304 or 316 stainless steel.	
<b>Nominal Pressure</b>	up to 1450 psi (100 bar)	
<b>Pressure Rating</b>	Line sizes 1/4...24 in. In accordance with ASME B16.5 Class 150 or Flange Rating Class 300 Line sizes 26...72 in. AWWA C-207 Class D or Class E Flange Rating	
<b>Protection Class</b>	NEMA 4X (IP67), optional NEMA 6P (IP68)	
<b>Minimum Conductivity</b>	5 µS/cm (20 µS/cm for demineralized water)	
<b>Liner Material</b>	Hard/soft rubber	1...78 in. (DN 25...2000) 32...176° F (0...80° C)
	PTFE	1/2...24 in. (DN 15...600) -40...302° F (-40...150° C)
	Halar (ECTFE)	12 in. (DN 300) and larger -40...302° F (-40...150° C)
	PFA	1/4...3/8 in. (DN 6...10) —
<b>Electrodes Materials</b>	Hastelloy C (standard), Tantalum Platinum/Gold plated, Platinum/Rhodium	
<b>Housing</b>	<b>Standard:</b> Carbon steel welded; <b>Optional:</b> 316 or 304 stainless steel	
<b>Electrode Materials</b>	<b>Standard:</b> Hastelloy C22; <b>Optional:</b> 316 stainless steel, gold/platinum plated, tantalum, platinum/rhodium	
<b>Lay Length</b>	1/4...3/4 in. (DN 6...20)	6.7 in. (170 mm)
	1...2 in. (DN 25...50)	8.9 in. (225 mm)
	2-1/2...4 in. (DN 65...100)	11.0 in. (280 mm)
	5...8 in. (DN 125...200)	15.8 in. (400 mm)
	10...14 in. (DN 250...350)	19.7 in. (500 mm)
	16...28 in. (DN 400...700)	23.6 in. (600 mm)
	30...40 in. (DN 750...1000)	31.5 in. (800 mm)
	48...56 in. (DN 1200...1400)	39.4 in. (1000 mm)
	64 in. (DN 1600)	63.0 in. (1600 mm)
	72 in. (DN 1800)	70.9 in. (1800 mm)
78 in. (DN 2000)	78.7 in. (2000 mm)	

## Sensor Type II Dimensions

### Remote Version in. (mm)

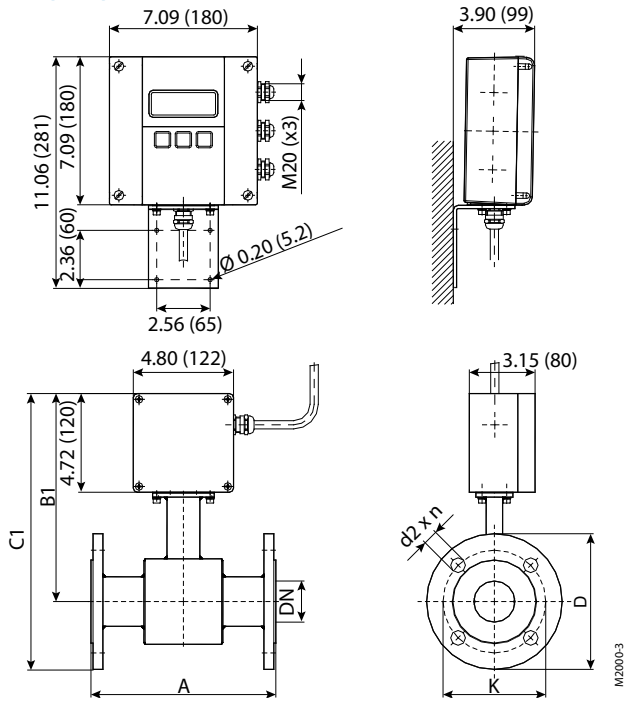

### Mounted Version in. (mm)

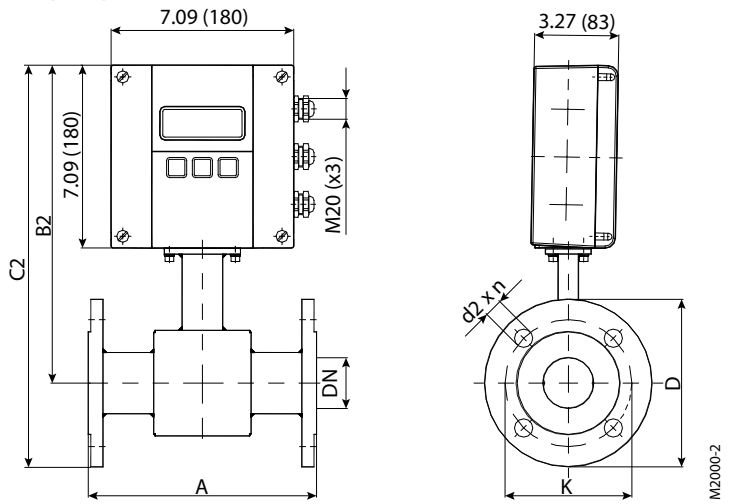

Size								with ANSI-flanges			with DIN-flanges		
in.	DN	A Std* in. (mm)	A ISO** in. (mm)	B1 in. (mm)	B2 in. (mm)	C1 in. (mm)	C2 in. (mm)	Ø D in. (mm)	Ø K in. (mm)	Ø d2xn in. (mm)	Ø D in. (mm)	Ø K in. (mm)	Ø d2xn in. (mm)
1/4	6	6.7 (170)	—	8.98 (228)	11.34 (288)	11.4 (288)	14.0 (356)	3.50 (88.9)	2.37 (60.3)	0.63 × 4 (15.9 × 4)	3.54 (90)	2.36 (60)	0.55 × 4 (14 × 4)
5/16	8	6.7 (170)	—	8.98 (228)	11.34 (288)	11.4 (288)	14.0 (356)	3.50 (88.9)	2.37 (60.3)	0.63 × 4 (15.9 × 4)	3.54 (90)	2.36 (60)	0.55 × 4 (14 × 4)
3/8	10	6.7 (170)	—	8.98 (228)	11.34 (288)	11.4 (288)	14.0 (356)	3.50 (88.9)	2.37 (60.3)	0.63 × 4 (15.9 × 4)	3.54 (90)	2.36 (60)	0.55 × 4 (14 × 4)
1/2	15	6.7 (170)	7.87 (200)	9.37 (238)	11.73 (298)	11.4 (288)	14.0 (356)	3.50 (88.9)	2.37 (60.3)	0.63 × 4 (15.9 × 4)	3.74 (95)	2.56 (65)	0.55 × 4 (14 × 4)
3/4	20	6.7 (170)	7.87 (200)	9.37 (238)	11.73 (298)	11.5 (293)	14.2 (361)	3.87 (98.4)	2.75 (69.8)	0.63 × 4 (15.9 × 4)	4.13 (105)	2.95 (75)	0.55 × 4 (14 × 4)
1	25	8.9 (225)	7.87 (200)	9.37 (238)	11.73 (298)	11.7 (298)	14.4 (366)	4.25 (107.9)	3.13 (79.4)	0.63 × 4 (15.9 × 4)	4.53 (115)	3.35 (85)	0.55 × 4 (14 × 4)
1-1/4	32	8.9 (225)	7.87 (200)	9.96 (253)	12.32 (313)	12.5 (318)	15.2 (386)	4.63 (117.5)	3.50 (88.9)	0.63 × 4 (15.9 × 4)	5.51 (140)	3.94 (100)	0.71 × 4 (18 × 4)
1-1/2	40	8.9 (225)	7.87 (200)	9.96 (253)	12.32 (313)	12.7 (322)	15.4 (390)	5.00 (127)	3.87 (98.4)	0.63 × 4 (15.9 × 4)	5.91 (150)	4.33 (110)	0.71 × 4 (18 × 4)
2	50	8.9 (225)	7.87 (200)	9.96 (253)	12.32 (313)	13.2 (335)	15.9 (403)	6.00 (152.4)	4.75 (120.6)	0.75 × 4 (19 × 4)	6.50 (165)	4.92 (125)	0.71 × 4 (18 × 4)
2-1/2	65	11.0 (280)	7.87 (200)	10.67 (271)	13.05 (331)	14.4 (366)	17.1 (434)	7.00 (177.8)	5.50 (139.7)	0.75 × 4 (19 × 4)	7.28 (185)	5.71 (145)	0.71 × 8 (18 × 8)
3	80	11.0 (280)	7.87 (200)	10.67 (271)	13.05 (331)	14.7 (372)	17.3 (440)	7.50 (190.5)	6.00 (152.4)	0.75 × 4 (19 × 4)	7.87 (200)	6.30 (160)	0.71 × 8 (18 × 8)
4	100	11.0 (280)	9.84 (250)	10.94 (278)	13.31 (338)	15.7 (398)	18.4 (466)	9.00 (228.6)	7.50 (190.5)	0.75 × 8 (19 × 8)	8.66 (220)	7.09 (180)	0.71 × 8 (18 × 8)
5	125	15.8 (400)	9.84 (250)	11.73 (298)	14.09 (358)	16.9 (430)	19.6 (498)	10.00 (254)	8.50 (215.9)	0.85 × 8 (22.2 × 8)	9.84 (250)	8.27 (210)	0.71 × 8 (18 × 8)
6	150	15.8 (400)	11.81 (300)	12.20 (310)	14.57 (370)	17.9 (456)	20.6 (524)	11.00 (279.4)	9.50 (241.3)	0.85 × 8 (22.2 × 8)	11.22 (285)	9.45 (240)	0.87 × 8 (22 × 8)
8	200	15.8 (400)	13.78 (350)	13.31 (338)	15.67 (398)	20.4 (518)	22.5 (572)	13.50 (342.9)	11.75 (298.4)	0.85 × 8 (22.2 × 8)	13.39 (340)	11.61 (295)	0.87 × 12 (22 × 12)
10	250	19.7 (500)	17.72 (450)	14.25 (362)	16.61 (422)	24.1 (613)	26.8 (681)	16.00 (406.4)	14.25 (361.9)	1.00 × 12 (25.4 × 12)	15.55 (395)	13.78 (350)	0.87 × 12 (22 × 12)

Size		A Std* in. (mm)	A ISO** in. (mm)	B1 in. (mm)	B2 in. (mm)	C1 in. (mm)	C2 in. (mm)	with ANSI-flanges			with DIN-flanges		
in.	DN							Ø D in. (mm)	Ø K in. (mm)	Ø d2×n in. (mm)	Ø D in. (mm)	Ø K in. (mm)	Ø d2×n in. (mm)
12	300	19.7 (500)	19.69 (500)	16.73 (425)	19.09 (485)	26.2 (666)	28.9 (734)	19.00 (482.6)	17.00 (431.8)	1.00 × 12 (25.4 × 12)	17.52 (445)	15.75 (400)	0.87 × 12 (22 × 12)
14	350	19.7 (500)	21.65 (550)	17.72 (450)	20.08 (510)	28.2 (716)	30.8 (782)	21.00 (533.4)	18.75 (476.2)	1.13 × 12 (28.6 × 12)	19.88 (505)	18.11 (460)	0.87 × 16 (22 × 16)
16	400	23.6 (600)	23.62 (600)	18.70 (475)	21.06 (535)	31.0 (788)	33.7 (856)	23.50 (596.9)	21.25 (539.7)	1.13 × 16 (28.6 × 16)	22.24 (565)	20.28 (515)	1.02 × 16 (26 × 16)
18	450	23.6 (600)	—	19.69 (500)	22.05 (560)	32.4 (822)	35.0 (890)	25.00 (635.0)	22.75 (577.8)	1.25 × 16 31.7 × 16	24.21 (615)	22.24 (565)	1.02 × 20 (26 × 20)
20	500	23.6 (600)	—	20.67 (525)	23.03 (585)	35.5 (901)	38.2 (969)	27.50 (698.5)	25.00 (635.0)	1.25 × 20 (31.7 × 20)	26.38 (670)	24.41 (620)	1.02 × 20 (26 × 20)
22	550	23.6 (600)	—	21.65 (550)	24.02 (610)	36.9 (937)	39.6 (1005)	29.50 (749.3)	27.25 (692.1)	1.37 × 20 (34.9 × 20)	—	—	—
24	600	23.6 (600)	—	23.15 (588)	25.51 (648)	39.5 (1003)	42.2 (1071)	32.00 (812.8)	29.50 (749.3)	1.37 × 20 (34.9 × 20)	30.71 (780)	28.54 (725)	1.18 × 20 (30 × 20)
26	650	23.6 (600)	—	24.13 (613)	26.50 (673)	—	—	32.25 (869.9)	31.75 (806.4)	1.37 × 24 (34.9 × 24)	—	—	—
28	700	23.6 (600)	—	24.61 (625)	26.97 (685)	44.0 (1118)	46.2 (1173)	36.50 (927.1)	34.00 (863.6)	1.38 × 28 (35.1 × 28)	35.24 (895)	33.07 (840)	1.18 × 24 (30 × 24)
30	750	31.5 (800)	—	25.59 (650)	27.95 (710)	45.7 (1161)	48.3 (1228)	38.75 (984.2)	36.00 (914.4)	1.37 × 28 (34.9 × 28)	—	—	—
32	800	31.5 (800)	—	26.89 (683)	29.25 (743)	49.5 (1257)	52.2 (1325)	41.75 (1060.5)	38.50 (977.9)	1.63 × 28 (41.3 × 28)	39.96 (1015)	37.40 (950)	1.30 × 24 (33 × 24)
34	850	31.5 (800)	—	27.87 (708)	30.24 (768)	—	—	43.75 (1111.2)	40.50 (1028.7)	1.63 × 32 (41.3 × 32)	—	—	—
36	900	31.5 (800)	—	28.54 (725)	30.91 (785)	54.1 (1374)	55.3 (1405)	46.00 (1168.4)	42.75 (1085.8)	1.63 × 32 (41.3 × 32)	43.90 (1115)	41.34 (1050)	1.30 × 28 (33 × 28)
38	950	31.5 (800)	—	29.53 (750)	31.89 (810)	—	—	48.75 (1238.3)	45.25 (1149.4)	1.63 × 32 (41.3 × 32)	—	—	—
40	1000	31.5 (800)	—	31.10 (790)	33.46 (850)	57.4 (1457)	60.0 (1525)	53.00 (1346.2)	49.50 (1257.3)	1.63 × 36 (41.3 × 36)	48.43 (1230)	45.67 (1160)	1.42 × 28 (36 × 28)
42	1050	39.4 (1000)	—	—	—	63.4 (1610)	66.0 (1675)	—	—	—	—	—	—
48	1200	39.4 (1000)	—	35.43 (900)	37.80 (960)	67.2 (1707)	69.9 (1775)	59.51 (1511.5)	56.00 (1422.4)	1.63 × 44 (41.3 × 44)	57.28 (1455)	54.33 (1380)	1.54 × 32 (39 × 32)
54	1350	39.4 (1000)	—	38.39 (975)	40.75 (1035)	73.0 (1927)	75.4 (1915)	66.25 (1682.8)	62.75 (1593.9)	1.88 × 44 (47.8 × 44)	—	—	—
56	1400	39.4 (1000)	—	39.37 (1000)	41.73 (1060)	—	—	—	—	—	65.94 (1675)	62.60 (1590)	1.65 × 36 (42 × 36)
Standard													
with ANSI-flanges			1/4...56 in. (DN 6 - 1400)				pressure rate 150 psi (10 bar)						
with DIN flanges			1/4...8 in. (DN 6 - 200)				pressure rate 230 psi (16 bar)						
			10...56 in. (DN 250 - 1400)				pressure rate 150 psi (10 bar)						
* Standard **ISO 20456													

Flange Sizes ≤ 24 in., Standard: ANSI B16.5 Class 150 RF forged carbon steel; Optional: 300 lb forged carbon steel, 316 or 304 stainless steel

Flange Sizes > 24 in., Standard: AWWA Class D Flanges RF forged carbon steel

### Sensor Type III Specifications

Thanks to its very short lay length, the sensor type III is often the right alternative to a lot of applications. Delivered with a PTFE liner, the sensor type III has a standard nominal pressure of PN 40.

<b>Size</b>	1...4 in. (DN 25...100)	
<b>Process Connection</b>	Wafer connection (in-between flange mounting)	
<b>Nominal Pressure</b>	580 psi (40 bar)	
<b>Protection Class</b>	NEMA 4X (IP67), optional NEMA 6P (IP68)	
<b>Minimum Conductivity</b>	5 µS/cm (20 µS/cm for demineralized water)	
<b>Liner Materials</b>	PTFE	
<b>Electrode Material</b>	Hastelloy C (Standard), Tantal, Platinum/Gold Plated, Platinum/Rhodium	
<b>Housing</b>	Carbon Steel/optional stainless steel	
<b>Lay Length</b>	1...2 in. (DN 25...50)	4 in. (100 mm)
	2-1/2...4 in. (DN 65...100)	6 in. (150 mm)

### Sensor Type III Dimensions

#### Remote Version in. (mm)

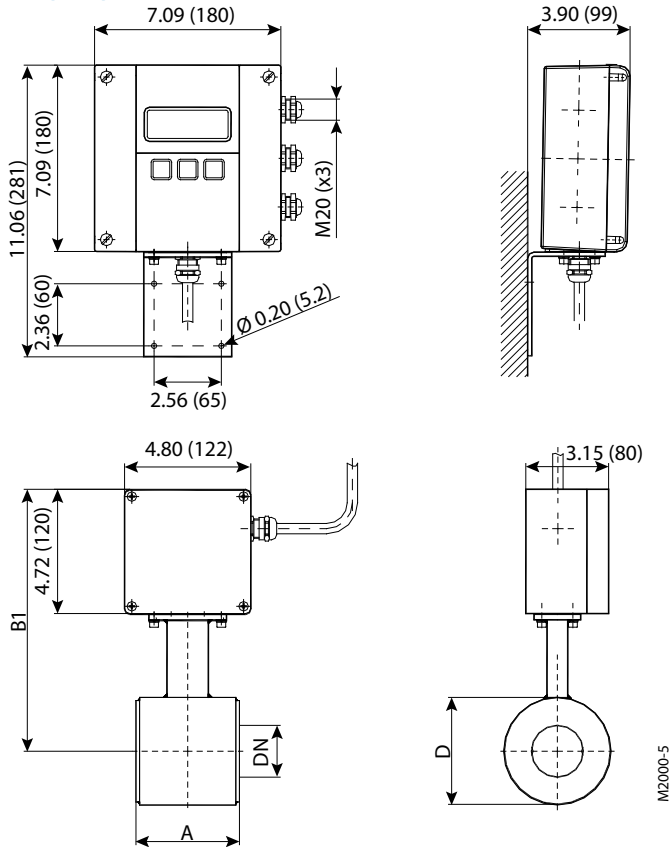

#### Mounted Version in. (mm)

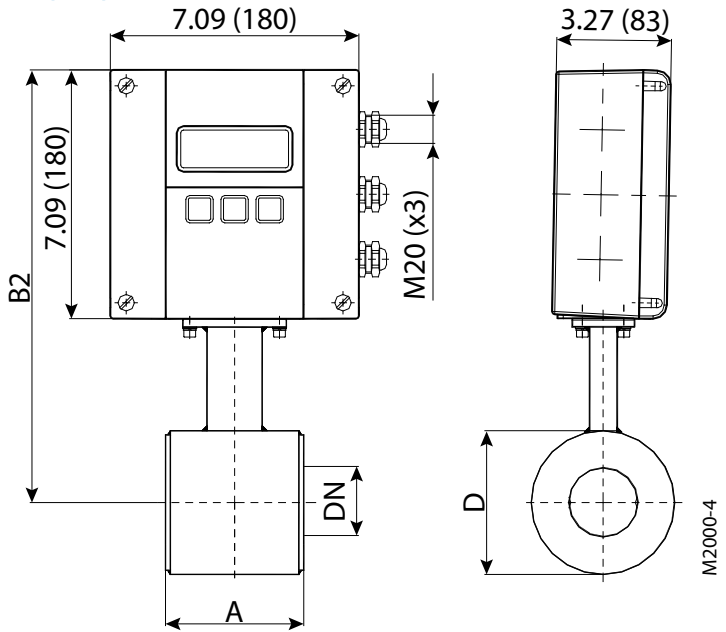

in.	DN	A	B1	B2	D
1	25	3.94 (100)	9.37 (238)	7.24 (184)	2.91 (74)
1-1/4	32	3.94 (100)	9.57 (243)	7.44 (189)	3.31 (84)
1-1/2	40	3.94 (100)	9.76 (248)	7.64 (194)	3.70 (94)
2	50	3.94 (100)	9.96 (253)	7.83 (199)	4.09 (104)
2-1/2	65	5.91 (150)	10.47 (266)	8.35 (212)	5.08 (129)
3	80	5.91 (150)	10.67 (271)	8.54 (217)	5.51 (140)
4	100	5.91 (150)	10.98 (279)	8.86 (225)	6.14 (156)

580 psi (40 bar)

### Sensor with Sanitary Process Connections Specifications

The sensor model is available with Tri-Clamp® BS4825/ISO2852, DIN 11851, and more process connections. The sanitary sensor is delivered in a stainless steel housing and with PTFE/PFA lining.

<b>Size</b>	3/8...4 in. (DN 10...100)		
<b>Process Connection</b>	Tri-Clamp BS4825/ISO2852, DIN 11851, customer specified, and more		
<b>Nominal Pressure</b>	145/230 psi (10/16 bar)		
<b>Protection Class</b>	NEMA 4X (IP67), optional NEMA 6P (IP68)		
<b>Minimum Conductivity</b>	5 µS/cm (20 µS/cm for demineralized water)		
<b>Liner Materials</b>	PTFE/PFA	-40...302° F (-40...150° C)	
<b>Electrode Material</b>	<b>Standard:</b> Hastelloy C; <b>Optional:</b> Tantal, Platinum / Gold plated, Platinum / Rhodium		
<b>Housing</b>	<b>Standard:</b> Carbon Steel; <b>Optional:</b> Stainless Steel		
<b>Lay Length</b>	Tri-Clamp Connection	3/8...2 in. (DN 10...50)	6 in. (145 mm)
		2-1/2...4 in. (DN 65...100)	8 in. (200 mm)
	DIN 11851 Connection	3/8...3/4 in. (DN 10...20)	7 in. (175 mm)
		1...2 in. (DN 25...50)	9 in. (225 mm)
		2-1/2...4 in. (DN 65...100)	11 in. (280 mm)

### DIN 11851 Connection Dimensions

**Remote Version**  
in. (mm)

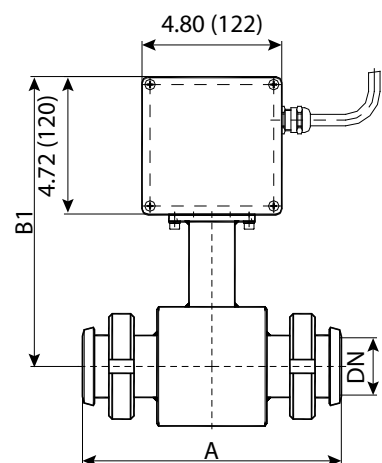
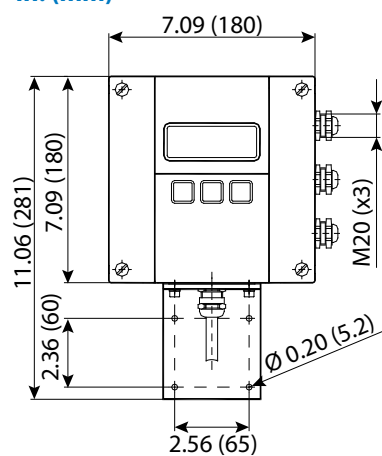

**Mounted Version**  
in. mm

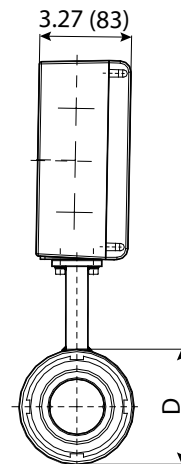
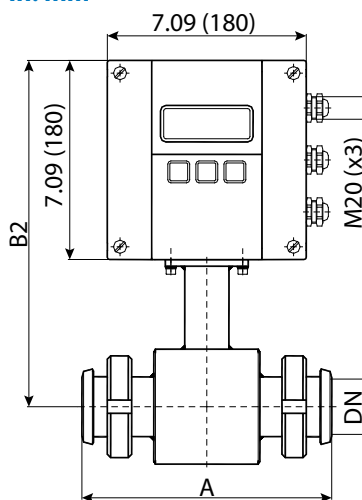
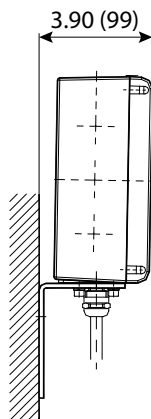

in.	DN	A	B1	B2	D
3/8	10	6.69 (170)	9.37 (238)	7.24 (184)	2.91 (74)
1/2	15	6.69 (170)	9.37 (238)	7.24 (184)	2.91 (74)
3/4	20	6.69 (170)	9.37 (238)	7.24 (184)	2.91 (74)
1	25	8.86 (225)	9.37 (238)	7.24 (184)	2.91 (74)
1-1/4	32	8.86 (225)	9.57 (243)	7.44 (189)	3.31 (84)
1-1/2	40	8.86 (225)	9.76 (248)	7.64 (194)	3.70 (94)
2	50	8.86 (225)	9.96 (253)	7.83 (199)	4.09 (104)
2-1/2	65	11.02 (280)	10.47 (266)	8.35 (212)	5.08 (129)
3	80	11.02 (280)	10.67 (271)	8.54 (217)	5.51 (140)
4	100	11.02 (280)	10.98 (279)	8.86 (225)	6.14 (156)

230 psi (16 bar)

### Tri-Clamp Connection Dimensions

#### Remote Version in. (mm)

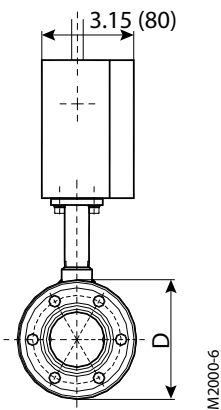
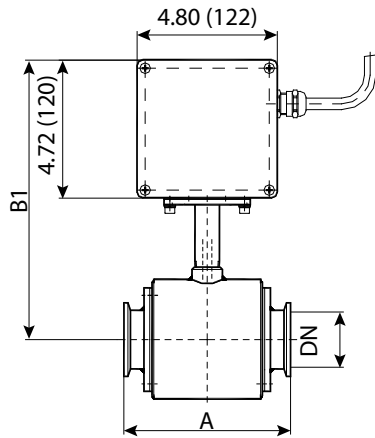
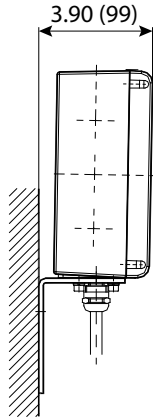
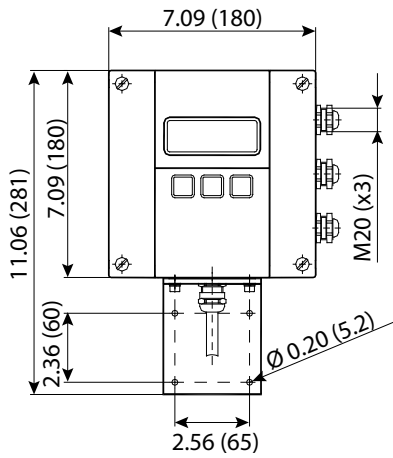

#### Mounted Version in. (mm)

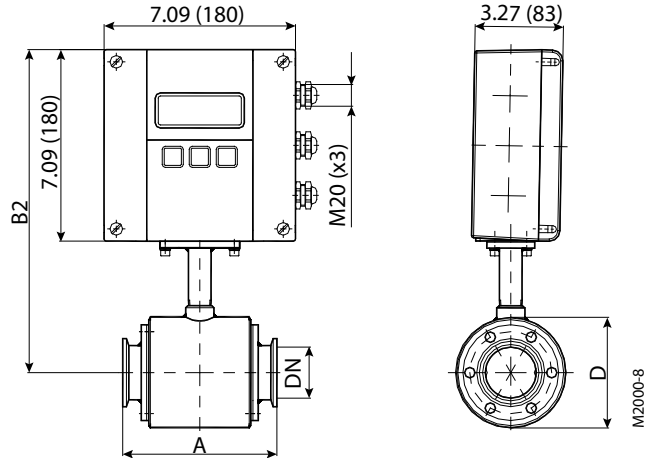

in.	DN	A	B1	B2	D
3/8	10	5.71 (145)	8.98 (228)	7.52 (191)	2.91 (74)
1/2	15	5.71 (145)	8.98 (228)	7.52 (191)	2.91 (74)
3/4	20	5.71 (145)	8.98 (228)	7.52 (191)	2.91 (74)
1	25	5.71 (145)	8.98 (228)	7.52 (191)	2.91 (74)
1-1/2	40	5.71 (145)	9.37 (238)	7.91 (201)	3.70 (94)
2	50	5.71 (145)	9.57 (243)	8.11 (206)	4.09 (104)
2-1/2	65	7.87 (200)	10.08 (256)	8.62 (219)	5.08 (129)
3	80	7.87 (200)	10.28 (261)	8.82 (224)	5.51 (140)
4	100	7.87 (200)	10.59 (269)	9.13 (232)	6.14 (156)

150 psi (10 bar)

### Tri-Clamp Connection Dimensions

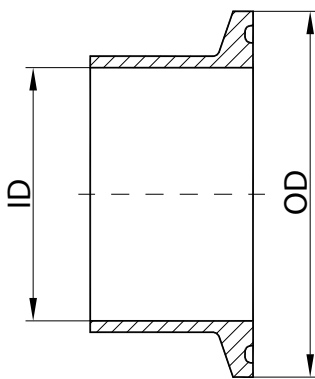

BS4825					ISO2852				
Size	OD		ID		Size	OD		ID	
in.	in.	mm	in.	mm	DN	in.	mm	in.	mm
—	—	—	—	—	10	0.98	25.0	0.55	14.0
1/2	0.98	25.0	0.37	9.4	15	1.99	50.5	0.71	18.1
3/4	0.98	25.0	0.62	15.75	20	1.99	50.5	0.90	22.9
1	1.99	50.5	0.87	22.1	25	1.99	50.5	1.13	28.7
—	—	—	—	—	32	2.52	64.0	1.51	38.4
1-1/2	1.99	50.5	1.37	34.8	40	2.52	64.0	1.74	44.3
2	2.52	64.0	1.87	47.5	50	3.05	77.5	2.22	56.3
2-1/2	3.05	77.5	2.37	60.2	65	3.58	91.0	2.84	72.1
3	3.58	91.0	2.87	72.9	80	4.17	106.0	3.32	84.3
4	4.69	119.0	3.83	97.4	100	5.12	130.0	4.32	109.7

Nominal Pressure 145 psi (10 bar)

## Error Limits

<b>Measuring Range</b>	0.10...39.37 ft/s (0.03...12 m/s)
<b>Pulse Output</b>	$\pm 0.2\%$ of m.v. $\pm 1$ mm/s
<b>Analog Output</b>	Similar to pulse output plus $\pm 0.01$ mA
<b>Reproducibility</b>	$\pm 0.1\%$

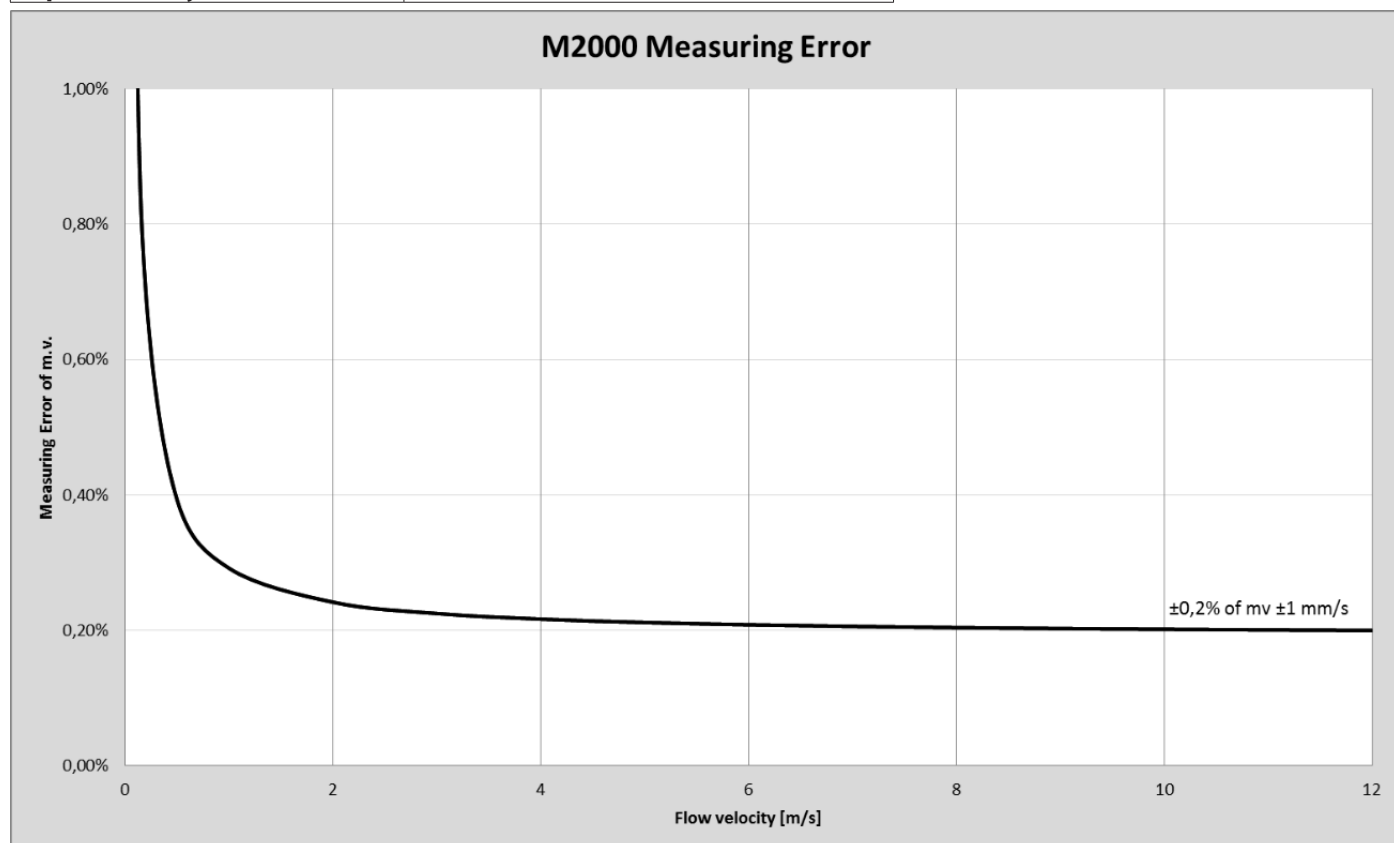

<b>Reference Conditions</b>	
<b>Ambient and Fluid Temperature</b>	68° F (20° C)
<b>Electrical Conductivity</b>	>300 $\mu$ S/cm
<b>Warm-up Period</b>	60 min
<b>Mounting Conditions</b>	>3/8 in. (10 DN) inlet pipe
	>1/4 in. (5 DN) outlet pipe
	Sensor properly grounded and centered

## SIZE SELECTION

Size		Estimated Weight with M2000	Flow Range	
in.	DN		US	Metric
1/4	6	8 (3.5)	0.0134...5.4 GPM	0.051...20.4 l/min
5/16	8	8 (3.5)	0.0239...9.6 GPM	0.09...36.2 l/min
3/8	10	8 (3.5)	0.0373...14.9 GPM	0.141...57 l/min
1/2	15	10 (4.5)	0.084...33.6 GPM	0.318...127 l/min
3/4	20	10 (4.5)	0.149...60 GPM	0.57...226 l/min
1	25	11 (5)	0.233...93 GPM	0.88...353 l/min
1-1/4	32	13 (6)	0.382...153 GPM	1.45...579 l/min
1-1/2	40	15.5 (7)	0.6...239 GPM	2.26...905 l/min
2	50	19 (8.5)	0.93...373 GPM	3.53...1,414 l/min
2-1/2	65	27.5 (12.5)	1.58...631 GPM	0.358...143 m <sup>3</sup> /h
3	80	31 (14)	2.39...956 GPM	0.54...217 m <sup>3</sup> /h
4	100	42 (19)	3.73...1,494 GPM	0.85...339 m <sup>3</sup> /h
5	125	53 (24)	5.8...2,334 GPM	1.33...530 m <sup>3</sup> /h
6	150	60.5 (27.5)	8.4...3,361 GPM	1.91...763 m <sup>3</sup> /h
8	200	87 (39.5)	14.9...5,975 GPM	3.39...1,357 m <sup>3</sup> /h
10	250	129 (58.5)	23.3...9,336 GPM	5.3...2,121 m <sup>3</sup> /h
12	300	204 (92.5)	33.6...13,444 GPM	7.6...3,054 m <sup>3</sup> /h
14	350	262 (119)	45.7...18,299 GPM	10.4...4,156 m <sup>3</sup> /h
16	400	344 (156)	60...23,901 GPM	13.6...5,429 m <sup>3</sup> /h
18	450	397 (180)	76...30,250 GPM	17.2...6,870 m <sup>3</sup> /h
20	500	470 (213)	93...37,345 GPM	21.2...8,482 m <sup>3</sup> /h
22	550	549 (249)	113...45,188 GPM	25.7...10,263 m <sup>3</sup> /h
24	600	617 (280)	134...53,777 GPM	30.5...12,214 m <sup>3</sup> /h
28	700	—	183...73,197 GPM	41.6...16,625 m <sup>3</sup> /h
30	750	930 (422)	210...84,027 GPM	47.7...19,085 m <sup>3</sup> /h
32	800	1171 (531)	239...95,604 GPM	54.3...21,714 m <sup>3</sup> /h
36	900	1378 (625)	302...120,999 GPM	69...27,482 m <sup>3</sup> /h
40	1000	—	373...149,381 GPM	85...33,928 m <sup>3</sup> /h
48	1200	1788 (811)	538...215,109 GPM	122...48,857 m <sup>3</sup> /h
56	1400	—	732...292,787 GPM	166...66,499 m <sup>3</sup> /h
60	1500	2112 (958)	840...336,108 GPM	191...76,338 m <sup>3</sup> /h
64	1600	2339 (1061)	956...382,416 GPM	217...86,856 m <sup>3</sup> /h
72	1800	3219 (1460)	1210...483,996 GPM	275...109,927 m <sup>3</sup> /h
78	2000	4101 (1860)	1494...597,525 GPM	339...135,713 m <sup>3</sup> /h



# SPARE PARTS

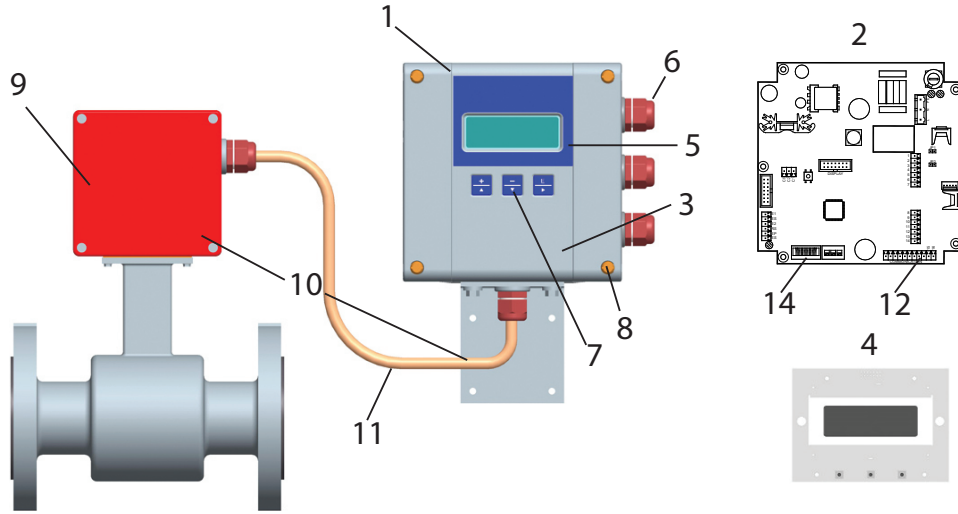

Item	Description	Part Number North America	Description	Part number International
1	Transmitter assembly, complete (110V AC)	66815-004	85...265V AC	592500
	Transmitter assembly, complete (24V DC)	66815-006	9...36V DC	592501
2	Printed circuit board assembly (110V AC)	66815-002	85...265V AC Board	384619
	Printed circuit board assembly (24V DC)	66815-005	9...36V DC Board	384623
3	—	—	Housing	384615
4	LCD display kit	66815-001	—	384602
5	—	—	Display window	384612
6	Cable gland	66796-001	—	382859
7	—	—	Buttons kit black	384610
8	Ball screw (for housing)	66312-001	—	384607
9	—	—	IP68 kit for remote version	383077
10	Remote mounting kit less cable (includes wall mount bracket)	63384-035	—	384629
11	<b>Cable options</b>		<b>Remote mounting kit with cable</b>	
	15 feet	64574-002	5 m	384631
	30 feet	64574-003	10 m	384632
	50 feet	64574-004	15 m	384633
	100 feet	64574-005	20 m	384634
	150 feet	64574-006	25 m	384635
	200 feet	64785-006	30 m	384636
	250 feet	64785-007	35 m	384637
	300 feet	64785-002	40 m	384671
	350 feet	64785-003	45 m	384676
	400 feet	64785-004	50 m	384639
	500 feet	64785-005	—	—
Not Shown	Cover (includes cover, lens, and buttons)	66815-003	—	—
	RS485 Modbus RTU Daughterboard Kit	67079-003	ModBus RTU RS485 Kit	592506
	—	—	M-Bus Kit	592507
	HART Daughterboard Kit	67079-001	—	592508
	PROFIBUS Daughterboard Kit	67079-002	—	592509
	—	—	PC programming kit	592510
	Firmware Upgrade (black token)	67354-003	—	—
	Store/restore (red token)	67354-006	—	592511
	Data logging (blue token)	67354-007	—	592512
	Verification Device	66849-001	—	—
Grounding Ring Kits (contact representative for part numbers for different sizes)	63528-xxx	—	—	

**INTENTIONAL BLANK PAGE**

**INTENTIONAL BLANK PAGE**

**Control. Manage. Optimize.**

ModMAG is a registered trademark of Badger Meter, Inc. Other trademarks appearing in this document are the property of their respective entities. Due to continuous research, product improvements and enhancements, Badger Meter reserves the right to change product or system specifications without notice, except to the extent an outstanding contractual obligation exists. © 2021 Badger Meter, Inc. All rights reserved.

[www.badgermeter.com](http://www.badgermeter.com)