



## CONTENTS

Safety Precautions and Instructions . . . . .	5
Basic Safety Recommendations . . . . .	5
Unpacking and Inspection . . . . .	6
Rigging, Lifting and Moving Large Units . . . . .	6
System Description . . . . .	8
Operating Principle . . . . .	8
Amplifier Mounting Configuration Options . . . . .	8
Meter Mounted Configuration . . . . .	8
Remote Mount Configuration. . . . .	8
Submersible Option. . . . .	8
Meter Location, Orientation and Applications . . . . .	9
Remote Option . . . . .	9
Temperature Ranges . . . . .	9
Protection Class . . . . .	10
Pipelines and Fluid Flow . . . . .	10
Meter Orientation . . . . .	11
Vertical Placement. . . . .	11
Horizontal Placement. . . . .	11
Straight Pipe Requirements . . . . .	11
Pipe Reducer Requirements . . . . .	12
Chemical Injection Applications . . . . .	12
Partially-Filled Pipe Situations. . . . .	13
Meter Gaskets and Grounding . . . . .	14
Meter/Pipeline Connection Gaskets . . . . .	14
Meter Grounding . . . . .	14
Conductive Pipe Grounding. . . . .	14
Non-Conductive Pipe Grounding . . . . .	15
Pipelines with Cathodic Protection . . . . .	15
Electrically Disturbed Environment . . . . .	15
Wiring. . . . .	16
Wiring Safety . . . . .	16
Opening the Cover. . . . .	16
Power. . . . .	17
Battery . . . . .	17

---

Battery Life . . . . .	17
Battery Replacement . . . . .	17
Battery Backup . . . . .	18
Installation. . . . .	19
Remote Mount Installation . . . . .	19
Signal Cable Specification . . . . .	21
Configuring Input/Output (I/O) . . . . .	22
Circuit Board Diagram. . . . .	22
User Interface. . . . .	24
Function Buttons. . . . .	24
Access the Programming Menu . . . . .	24
Display . . . . .	25
M5000 Main Menu Programming Options . . . . .	26
Navigating the Initial Main Screens . . . . .	26
Menu Structure. . . . .	27
Programming Menus . . . . .	30
Meter Setup Menu. . . . .	30
Measure Menu . . . . .	31
Inputs/Outputs Menu. . . . .	33
Communication Menu . . . . .	35
Battery Menu . . . . .	36
Miscellaneous Menu . . . . .	37
Information Menu . . . . .	38
Faults Menu . . . . .	38
Security. . . . .	39
Setting a PIN. . . . .	39
Activating the Security Feature. . . . .	39
Logging In . . . . .	40
Logging Out. . . . .	40
PIN Menu. . . . .	40
Maintenance . . . . .	41
Cleaning the Flow Tube and Electrode . . . . .	41
Replacing Circuit Board. . . . .	41
Troubleshooting . . . . .	42
Errors and Warnings. . . . .	43
Connecting an ORION RTR® Endpoint to the M5000 Meter . . . . .	44

---

Wiring . . . . . 44

Programming . . . . . 44

Connecting an ORION Encoder Endpoint to the M5000 Meter . . . . . 45

    Wiring . . . . . 45

    Programming . . . . . 45

Specifications . . . . . 46

    M5000 Amplifier . . . . . 46

    M5000 Amplifier Dimensions in Inches (Millimeters) . . . . . 46

    Detector Type VI . . . . . 47

    Error Limits. . . . . 49

OIML Approved Meter . . . . . 50

    MID Approved Meter (MI-001) . . . . . 51

Replacement Parts. . . . . 52

## SAFETY PRECAUTIONS AND INSTRUCTIONS

Some procedures in this manual require special safety considerations. In such cases, the text is emphasized with the following symbols:

**⚠ DANGER** Indicates a hazardous situation, which, if not avoided, will result in death or serious personal injury.

**⚠ WARNING** Indicates a hazardous situation, which, if not avoided, could result in death or serious personal injury.

**⚠ CAUTION** Indicates a hazardous situation, which, if not avoided, could result in minor or moderate personal injury or damage to property.

### Basic Safety Recommendations

Before installing or using this product, read this instruction manual thoroughly. Only qualified personnel should install and/or repair this product. If a fault appears, contact your distributor.

The electromagnetic flow meter is only suitable for the measurement of conductive fluids. The manufacturer is not liable for damages that result from improper use or from use that is not in accordance with the requirements.

The meters are constructed according to state-of-the-art technology and tested operationally reliable. They have left the factory in a faultless condition concerning safety regulations.

### Installation

Do not place any unit on an unstable surface that may allow it to fall.

Never place the units above a radiator or heating unit.

Route all cabling away from potential hazards.

Isolate from the mains before removing any covers.

### Setup and Operation

Adjust only those controls that are covered by the operating instructions. Improper adjustment of other controls may result in damage, incorrect operation or loss of data.

### RoHs

Our products are RoHs compliant.

### Battery Disposal

The batteries contained in our products need to be disposed of per your local legislation according to EU directive 2006/66/EG.

## UNPACKING AND INSPECTION

Follow these guidelines when unpacking the equipment.

- If a shipping container shows any sign of damage, have the shipper present when you unpack the meter.
- Follow all unpacking, lifting and moving instructions associated with the shipping container.
- Open the container and remove all packing materials. Store the shipping container and packing materials in the event the unit needs to be shipped for service.
- Verify that the shipment matches the packing list and your order form.
- Inspect the meter for any signs of shipping damage, scratches, or loose or broken parts.

**NOTE:** If the unit was damaged in transit, it is your responsibility to request an inspection report from the carrier within 48 hours. You must then file a claim with the carrier and contact Badger Meter for appropriate repairs or replacement.

- All detectors with polytetrafluoroethylene (PTFE) liners are shipped with a liner protector on each end to maintain proper form of the PTFE material during shipping and storage.

**NOTE:** Do not remove the liner protectors until you are ready to install.

- Storage: If the meter is to be stored, place it in its original container in a dry, sheltered location. Storage temperature ranges are:  $-40 \dots 160^{\circ} \text{F}$  ( $-40 \dots 70^{\circ} \text{C}$ ).

## Rigging, Lifting and Moving Large Units

### ⚠ CAUTION

**WHEN RIGGING, LIFTING OR MOVING LARGE UNITS, FOLLOW THESE GUIDELINES:**

- DO NOT lift or move a meter by its amplifier, junction box or cables.
- Use a crane rigged with soft straps to lift and move meters with flow tubes that are between two inches and eight inches (50 mm and 200 mm). Place the straps around the detector body, between the flanges, on each side of the detector.
- Use the lifting lugs when lifting meter flow tubes that are 10 inches (250 mm) in diameter or larger.

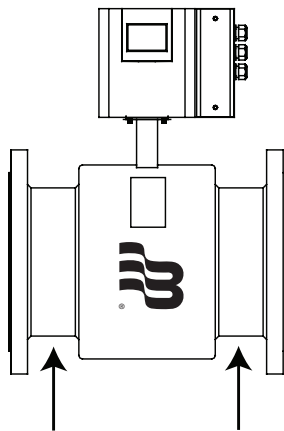

Place straps between flanges.

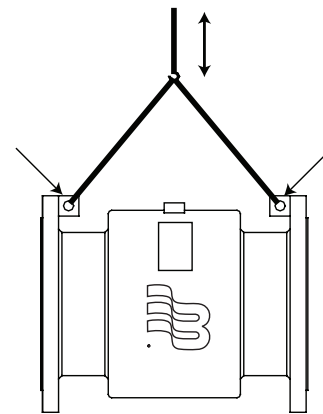

Use lifting lugs with 10-inch or larger meters.

Figure 1: Rigging large units

- Use the sling-rigged method to lift large detectors into a vertical position while they are still crated. Use this method to position large detectors vertically into pipelines.

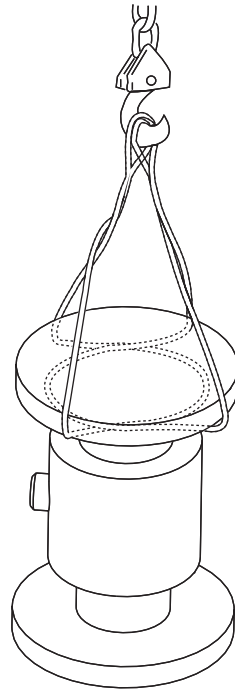
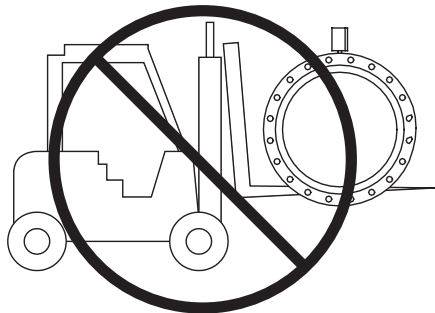
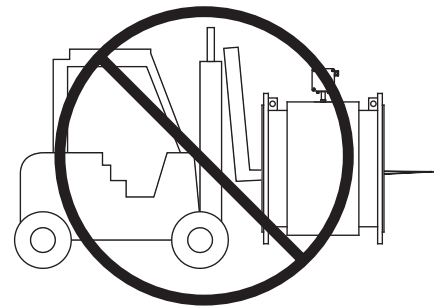

Figure 2: Sling-rigged lifting methods

- Do not lift a detector with a forklift by positioning the detector body on the forks, with the flanges extending beyond the lift. This could dent the housing or damage the internal coil assemblies.
- Never place forklift forks, rigging chains, straps, slings, hooks or other lifting devices inside or through the detector's flow tube to hoist the unit. This could damage the isolating liner.



Do not lift detector with forklift.



Do not lift or rig lifting devices through detector.

Figure 3: Lifting and rigging cautions

## SYSTEM DESCRIPTION

The Badger Meter model M5000 electromagnetic flow meter is intended for fluid metering in most industries including potable water, reclaimed water, food and beverage, pharmaceutical and chemical. The meter can measure all fluids with electric conductivity of at least 5  $\mu\text{S}/\text{cm}$  (20  $\mu\text{S}/\text{cm}$  for demineralized water) and is highly accurate. Measuring results depend on density, temperature and pressure.

The basic components of an electromagnetic flow meter are:

- The **detector**, which includes the flow tube, isolating liner and measuring electrodes.
- The **amplifier**, which is the electronic device responsible for the signal processing, flow calculation, display and output signals.

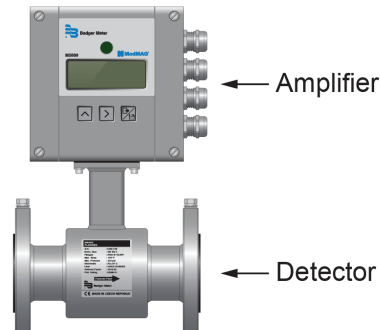

Figure 4: Amplifier and detector

The construction materials of the wetted parts (liner and electrodes) should be appropriate for the specifications on the intended type of service. We recommend that you review all of the compatibilities consistent with the specifications.

Each meter is factory tested and calibrated. A calibration certificate is included with each meter.

## OPERATING PRINCIPLE

In accordance with Faraday's induction principle, electric voltage is induced in a conductor moving through a magnetic field. In case of the electromagnetic flow measurement, the moving conductor is replaced by the flowing fluid. Two opposite measuring electrodes conduct the induced voltage which is proportional to flow velocity to the amplifier. Flow volume is calculated based on pipe diameter.

## AMPLIFIER MOUNTING CONFIGURATION OPTIONS

### Meter Mounted Configuration

The meter mount configuration has the amplifier mounted directly on the detector. This compact, self-contained configuration minimizes installation wiring.

### Remote Mount Configuration

The remote mount configuration places the amplifier at a location away from the fluid flow and detector. This is necessary in situations where process fluid temperature or the environment exceeds amplifier ratings.

The detector and amplifier are connected by wires, run through conduit, between junction boxes on the detector and the amplifier. The distance between the detector junction box and amplifier junction box can be up to 100 feet (30 meters). A remote mounting bracket is supplied.

### Submersible Option

If you are installing the meter in a vault, order the remote amplifier option. Do not install the amplifier inside a vault. We also recommend ordering the remote meter package with the submersible option (NEMA 6P/IP68) to eliminate any potential problems resulting from humidity or temporary flooding in the vault.

**NOTE:** NEMA 6P/IP68 enclosures are constructed for indoor or outdoor use to provide protection against access to hazardous parts, and to provide a degree of protection against ingress of solid foreign objects and water (hose directed water and the entry of water during prolonged submersion at a limited depth). They provide an additional level of protection against corrosion and are not damaged by the external formation of ice on the enclosure.



## METER LOCATION, ORIENTATION AND APPLICATIONS

The M5000 provides two amplifier mounting options: a meter mounted option and a remote option.

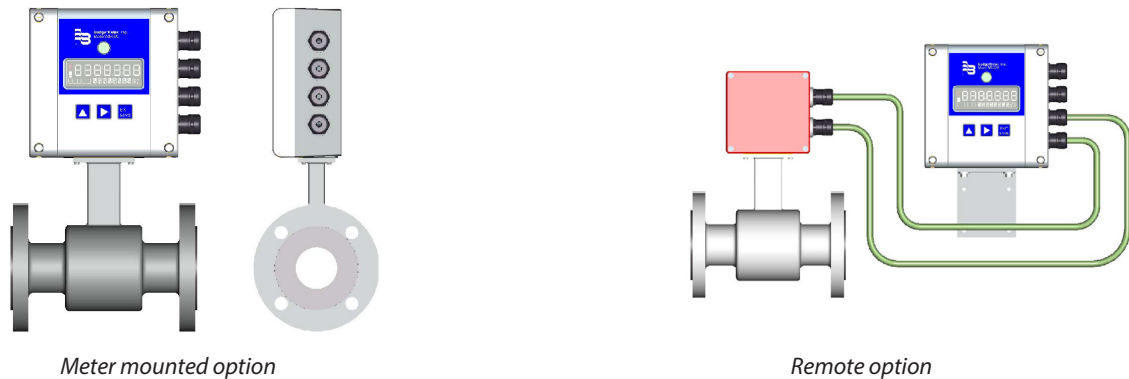

Figure 5: Amplifier mounting options

### Remote Option

Use a remote amplifier in the following situations:

- Detector protection class IP 68
- Detector to be mounted in a vault (see note on previous page)
- Fluid temperature is greater than 212° F (100° C)
- Strong vibrations at meter location

### Remote Amplifier Outdoor Location

The amplifier can be installed and operated outdoors. However, it must be protected from the elements, as follows:

- The ambient environment/temperature rating for the unit is -4...140° F (-20...60° C).
- If an indoor location is within 100 feet (30 meters) of the detector, consider increasing the cable length (up to 100 ft) and mounting the amplifier indoors.
- At minimum, fabricate a roof or shield over and/or around the amplifier to protect the LCD display screen from direct sunlight.
- Do not install the signal cable close to power cables, electric machines, and more.
- Secure the signal cables. Due to capacity changes, cable movements may result in incorrect measurements.

### Temperature Ranges

- To prevent the meter from any damage, strictly observe the amplifier's and detector's maximum temperature ranges.
- In regions with extremely high ambient temperatures, it is recommended to protect the detector.
- In cases where fluid temperature exceeds 212° F (100° C), use the remote amplifier option.

<b>Amplifier</b>	Ambient temperature	-4...140° F (-20...60° C)	
<b>Detector</b>	Fluid temperature	PTFE / PFA	-40...302° F (-40...150° C)
		Hard rubber	32...176° F (0...80° C)
		Soft rubber	32...176° F (0...80° C)

## Protection Class

The device has protection class IP 67, optional IP 68. In order to fulfill requirements in respect of the protection class, follow these guidelines:

- Body seals must be undamaged and in proper condition.
- All of the body screws must be firmly screwed.
- Outer diameters of the used wiring cables must correspond to cable inlets (for M20 Ø 7...12 mm). In cases where cable inlet is not used, put on a dummy plug.
- Tighten cable inlets.
- If possible, lead the cable downwards to avoid humidity going into cable inlet.
- We normally deliver the meter in accordance with protection class IP 67. If you require a higher protection class, use the remote version. If requested, we can also deliver the detector in IP 68.

## Pipelines and Fluid Flow

Take the following precautions during installation:

- Do not install the meter on pipes with extreme pipe vibrations. If pipes are vibrating, secure the piping with appropriate pipe supports in front of and behind the meter. If vibrations cannot be restrained, mount the amplifier in a remote location.
- Do not install the detector close to pipeline valves, fittings or impediments that can cause flow disturbances.
- For detectors with PTFE liners, do not install the detector on suction sides of pumps.
- Do not install the detector on outlet sides of piston or diaphragm pumps. Pulsating flow can affect meter performance.
- Avoid installing the detector near equipment that produces electrical interference such as electric motors, transformers, variable frequency and power cables.
- Verify that both ends of the signal cables are securely fastened.
- Place power cables and signal cables in separate conduits. Do not install the signal cable close to other sources of electricity, such as power cables or electric machines.
- Place the meter where there is enough access for installation and maintenance tasks.

## Meter Orientation

Mag meters can operate accurately in any pipeline orientation and can measure volumetric flow in forward and reverse directions, as long as the pipe is completely full.

**NOTE:** A "Forward Flow" direction arrow is printed on the detector label.

## Vertical Placement

Mag meters perform best when placed vertically, with liquid flowing upward and meter electrodes in a closed, full pipe.

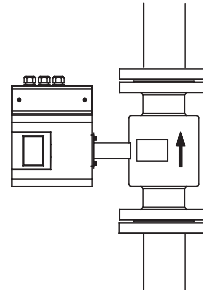

Figure 6: Vertical placement

Vertical placement allows the pipe to remain completely full, even in low flow, low pressure applications, and it prevents solids build-up, sediment deposit and accumulation on the liner and electrodes.

**NOTE:** Carefully observe the "Forward Flow" label on the meter body and install the meter accordingly. When installed vertically, rotate amplifier so that cable glands are facing down.

## Horizontal Placement

M5000 meters are equipped with an *Empty Pipe Detection* feature. If an empty pipe electrode mounted in the pipe is not covered by fluid for five seconds, the meter displays an Empty Pipe Detection condition. The meter sends out an error message and stops measuring flow. When the electrode is again covered with fluid, the error message disappears and the meter resumes measuring.

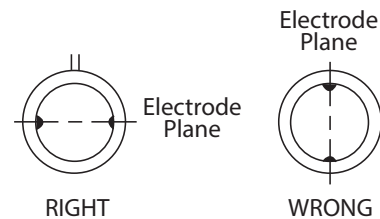

Figure 7: Horizontal placement

When installing the meter on a horizontal pipe, mount the detector to the pipe with the flow-measuring electrode axis in a horizontal plane (three and nine o'clock). This placement helps prevent solids build-up, sediment deposit and accumulation on the electrodes.

## Straight Pipe Requirements

Sufficient straight-pipe runs are required at the detector inlet and outlet for optimum meter accuracy and performance. An equivalent of 3...7 diameters of straight pipe is required on the inlet (upstream) side to provide a stable flow profile. Two diameters are required on the outlet (downstream) side.

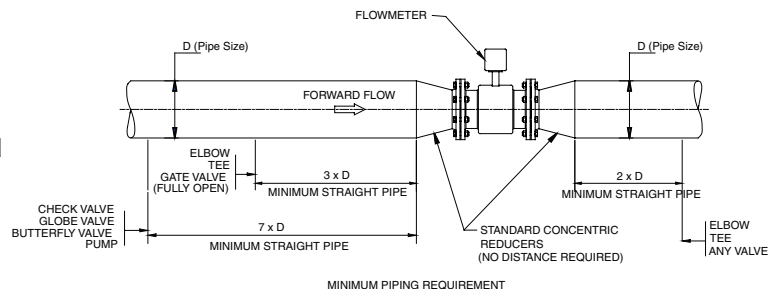

Figure 8: Straight pipe requirements

## Pipe Reducer Requirements

With pipe reducers, a smaller meter can be mounted in larger pipelines. This arrangement may increase low-flow accuracy. There are no special requirements for standard, concentric pipe reducers.

Custom fabricated pipe reducers must have a maximum slope angle of 8 degrees to minimize flow disturbances and excessive loss of head. If this is not possible, install the custom pipe reducers as if they were fittings and install the required amount of straight pipe.

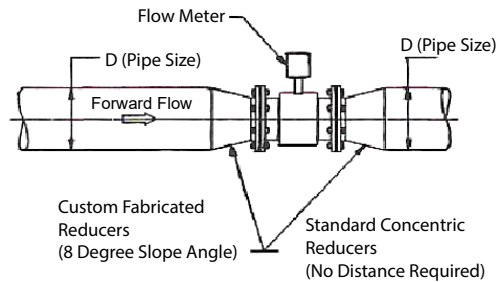

Figure 9: Pipe reducer requirements

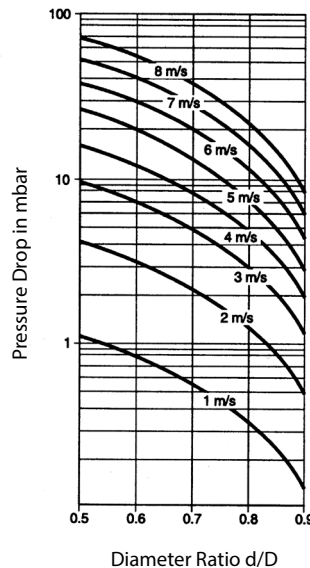

Figure 10: Pressure loss chart

## Chemical Injection Applications

For water line applications with a chemical injection point, install the meter upstream of the injection point. This eliminates any meter performance issues.

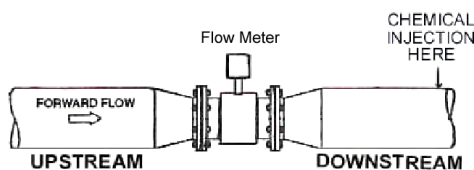

Figure 11: Chemical injection point downstream of meter

If a meter must be installed downstream of a chemical injection connection, the distance between the flange and the injection point should be between 50 and 100 feet (15 and 30 meters). The distance must be long enough to allow the water or chemical solution to reach the meter in a complete, homogeneous mixture.

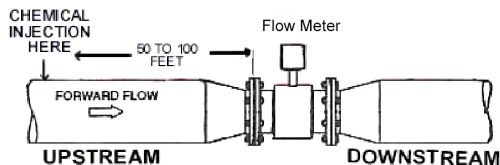

Figure 12: Chemical injection point upstream of meter

If the injection point is too close, the meter senses the two different conductivities for each liquid. This can cause inaccurate measurements. The injection method—spaced bursts, continuous stream of drips, liquid or gas—can also affect downstream readings by the meter.

## Partially-Filled Pipe Situations

In some locations, the process pipe may be momentarily only partially filled. Examples include: lack of back pressure, insufficient line pressure and gravity flow applications.

To eliminate these situations:

- Do not install the meter at the highest point of the pipeline.
- Do not install the meter in a vertical, downward flow section of pipe.
- Always position the ON/OFF valves on the downstream side of the meter.
- Turn ON *Empty Pipe* for applications or installations where the pipe is sometimes empty.
- Do not install the detector on the suction side of pumps. This could damage the liner (in particular PTFE liners).
- Do not install the detector on pipes with vibrations. If pipes are strongly vibrating, use a remote version.

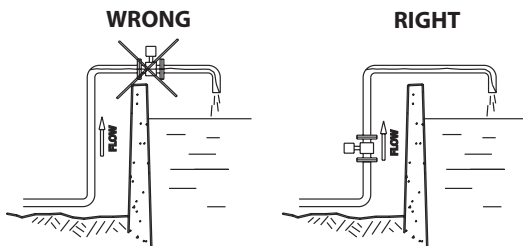
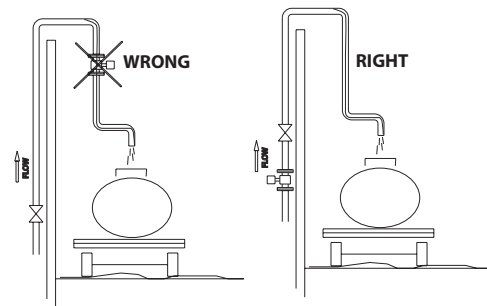

Figure 13: Incorrect meter placement



Do not install in a vertical, downward position.

Position "On/Off" valves on downstream side.

Figure 14: Position valves on downstream side

To minimize the possibility of partially-full pipe flows in horizontal, gravity or low pressure applications, create a pipe arrangement that allows the detector to remain full of liquid at all times.

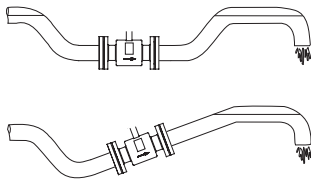

Figure 15: Pipe positioned to keep water in detector

## METER GASKETS AND GROUNDING

Consider gasket and grounding requirements when determining the meter location, orientation and application. Ground all units to eliminate risk of electric shock.

### ⚠ CAUTION

**FAILURE TO PROPERLY GROUND A UNIT MAY CAUSE DAMAGE TO THAT UNIT OR DATA STORED WITHIN IT.**

### Meter/Pipeline Connection Gaskets

Install gaskets (not provided) between the detector's isolating liner and the pipeline flange to ensure a proper and secure hydraulic seal. Use gaskets that are compatible with the fluid. Center each gasket on the flange to avoid flow restrictions or turbulence in the line.

During installation, do not use graphite or any electrically conductive sealing compound to hold the gaskets. This could compromise the accuracy of the measuring signal.

If you are using a grounding ring (as Badger Meter recommends) in the detector/pipeline connection, place the ring between two gaskets. (See ["Non-Conductive Pipe Grounding"](#) on page 15.)

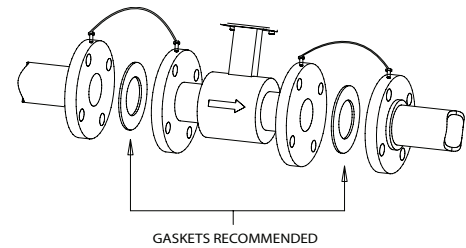

Figure 16: Meter/pipeline connection gaskets

### Meter Grounding

Process pipeline material can be either electrically conductive (metal) or not electrically conductive (made of or lined with PVC, fiberglass or concrete).

#### IMPORTANT

*It is essential that the mag meter amplifier's input ground (zero voltage reference) be electrically connected to the liquid media and to a good, solid earth ground reference.*

#### Potential Equalization

In order to obtain an accurate measurement, detector and fluid need to be on the same electric potential.

If flange or intermediate flange versions with additional grounding electrode are used, grounding is provided by the connected pipeline.

- If a type of meter with a flange connection cable (min. 4 mm<sup>2</sup>) between the grounding screw on the meter's flange and the counter flange is to be used in addition to the fixing screws, verify that the electric connection is complete.
- Color or corrosion on the counter flange may have a negative effect on the electric connection.

### Conductive Pipe Grounding

To achieve an adequate ground, the meter body **MUST** be electrically connected to the liquid media. The mag meter flanges are provided with grounding bolts for this purpose.

If the pipe material is electrically conductive, simply install grounding straps between these grounding bolts and the mating flanges.

These grounding straps must be copper wire, at least 12 AWG size. They must be connected on both sides (inlet and outlet) of the detector and to a local, earth ground.

To provide a good electrical connection at the mating flanges, Badger Meter recommends that you drill and tap the flanges and install a grounding screw (not provided).

## Non-Conductive Pipe Grounding

### IMPORTANT

If the process pipe is not electrically conductive (PVC, fiberglass, cement-lined pipes or any other non-conductive material) and the meter was not originally ordered with an optional grounding electrode, you must install a pair of grounding rings between the mating flanges at both ends of the meter. See the following illustration.

In this case, connect the grounding straps to both of the grounding rings and to a good, solid earth ground. Grounding rings are available in stainless steel. If your fluid is too aggressive for stainless steel, order a meter with the optional grounding electrode in a material compatible with the fluid.

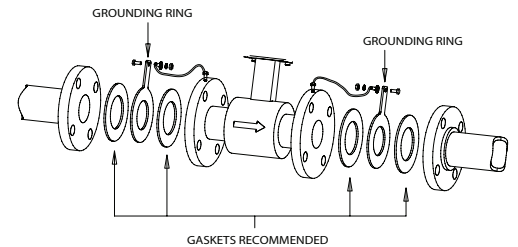

Figure 17: Non-conductive pipe grounding

## Pipelines with Cathodic Protection

For pipelines with cathodic protection, install the meter potential-free. No electric connection from the meter to the pipeline system may exist and the power supply is to be provided via isolating transformer.

### CAUTION

**USE GROUNDING ELECTRODES. INSTALL GROUNDING RINGS ISOLATED FROM THE PIPELINE.**

**OBSERVE NATIONAL RULES REGARDING POTENTIAL-FREE INSTALLATIONS.**

## Electrically Disturbed Environment

If the pipe material is in an electrically disturbed environment or if metallic pipelines that are not grounded are used, we recommend a grounding as shown in the following picture in order to make sure that measurement is not influenced.

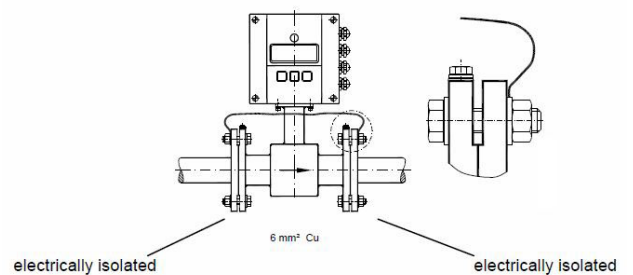

Figure 18: Potential-free installation

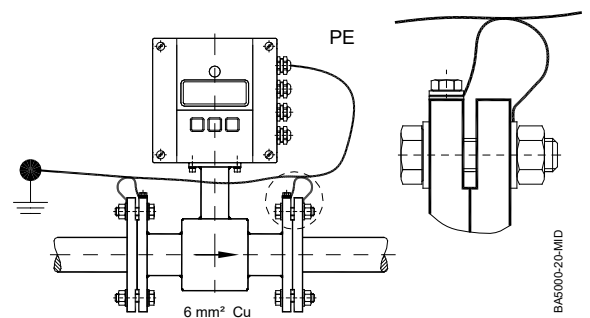

Figure 19: Grounding for electrically disturbed environment

## WIRING

### Wiring Safety

#### **WARNING**

- Disconnect power to the unit before attempting any connection or service.
- Do not bundle or route signal lines with power lines.
- Use twisted pair shielded wire for all output wiring.
- For the 4 × M20 cable inlets, only use flexible electric cables.
- Observe all applicable, local electrical codes.

### Opening the Cover

The M5000 amplifier's design lets you open the cover without completely removing it.

Follow these steps:

1. Completely remove the top two screws from the amplifier using a blade/slotted screwdriver.
2. Loosen both of the bottom screws so that the round head of each screw clears the top face of the cover.
3. Pull the cover down to the open position.



Figure 20: Remove two screws



Figure 21: Open the cover



## POWER

The M5000 can be powered with:

- Battery only (2 D-cells or 4 D-cells)
- 100...240V AC (with battery back-up)
- 9...36V DC (with battery back-up)

### Battery

Use a two D-cell battery pack for sizes 1/2...6 in. (DN 15...150) or a double two D-cell battery pack for sizes 8...24 in. (DN 200...600). For backup battery options, see "[Battery Backup](#)" on page 18.

The meter is delivered with the battery unplugged. It must be plugged in before using the meter. The connection jack is located by the symbol "BAT" on the board.

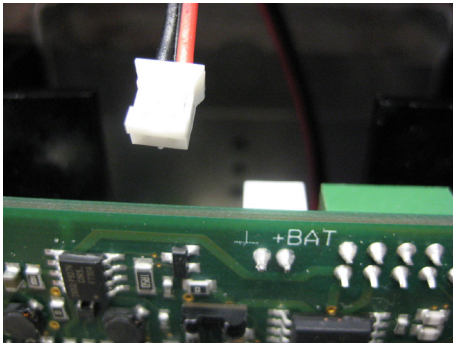

Figure 22: Battery connection

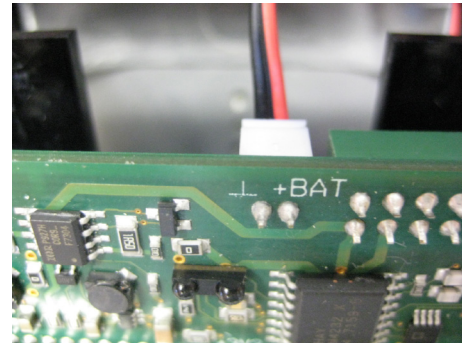

Figure 23: Battery plugged in

### Battery Life

**NOTE:** The battery life strongly depends on ambient temperature, sampling rate and the number of outputs used.

Standard Battery Pack	
Sampling	Expected Life
1 s	8 months
4 s	2.7 years
8 s	5.3 years
15 s	10 years

These calculations are for a standard battery pack, with two D-size batteries, with communication and outputs OFF, at a temperature of 77° F (25° C). See "[Battery Level Indicators](#)" on page 25.

### Battery Replacement

1. Go to *Main Menu > Misc > Battery > Change* and select the capacity of the battery pack to be installed (see label on the battery pack 19 Ah, 38 Ah or 70 Ah). Press **E** to quit. The display freezes (no reaction by pressing any button).
2. Open the cover.
3. Remove all connectors (detector and outputs).
4. Remove all 4 screws of the main board, remove the circuit board and disconnect the old battery.
5. Remove the old battery and wait about 2 minutes before replacing it with a new one (LCD display should be off).
6. Plug the battery connector into the back of the main board and reinstall the circuit board.
7. Replace all the plugs.
8. Close the cover tight.
9. Check time and date (*Main Menu > Misc > Time* and *Main Menu > Misc > Date DMY*).
10. Check capacity of battery (*Main Menu > Misc > Battery AH*). The first value is the used capacity, which should be 0.0. The second value is the capacity of the battery pack. *Battery AH* is a read-only parameter.

**NOTE:** Totalizers and configuration remain unaffected during battery replacement.

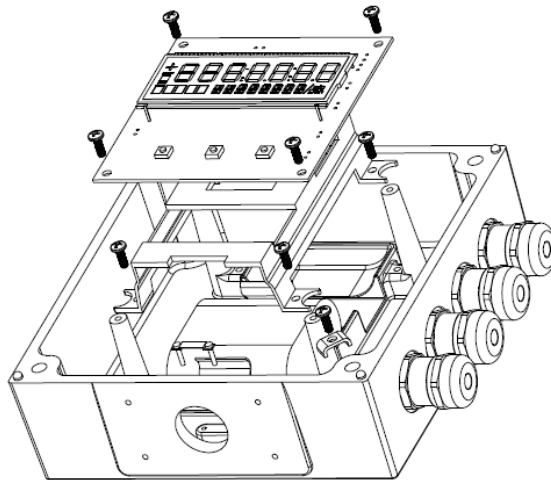

Figure 24: Amplifier housing components – exploded view

## Battery Backup

The backup battery option allows the meter to run using the backup battery power in case of power loss. The meter ships with an unplugged backup battery. Make sure that any power cables are of a sufficiently high current rating. If in doubt, contact your distributor.

### CAUTION

#### DO NOT INSTALL THE METER UNDER VOLTAGE

1. Connect the power supply according to the terminal marking.

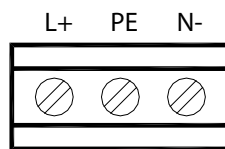

90...264V AC (50/60Hz)

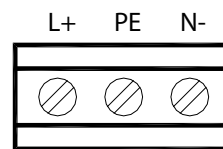

9...36V DC

**NOTE:** The safety fuse is soldered on the electronic board (1.6 A slow).

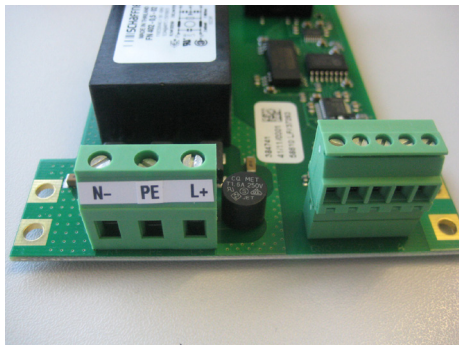

Figure 25: Power supply terminals

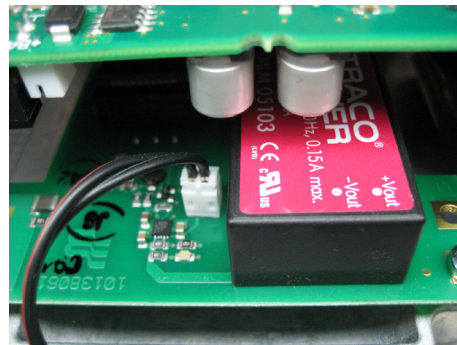

Figure 26: Backup battery location

2. Connect the battery to the connection socket on the power supply board. See [Figure 26](#).

## INSTALLATION

For detectors with PTFE liner, do not remove protective cap on the flange until shortly before installation.

### Remote Mount Installation

#### Mount Bracket to Amplifier

1. Align bracket-mounting holes with amplifier mounting holes.
2. Attach bracket to amplifier with supplied screws. Torque the screws to 80 inch-pounds.

#### Wiring Configuration

##### Connection on the amplifier

1. Open the cover of the amplifier.
2. Push both cables through two different cable glands as shown in [Figure 27](#).

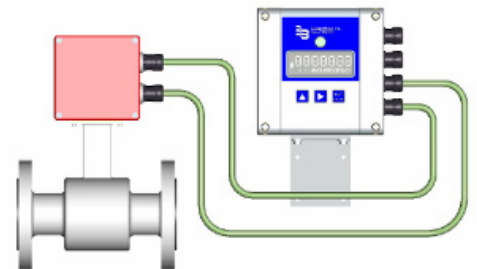

Figure 27: Cables in cable glands

3. The cable entry should be done as shown in [Figure 28](#).

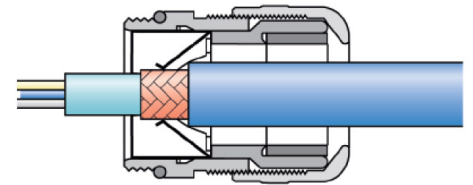

Figure 28: Cable entry

4. Connect the cables to the corresponding plugs on the left side of the board as shown in [Figure 29](#).
5. Close cover tight.

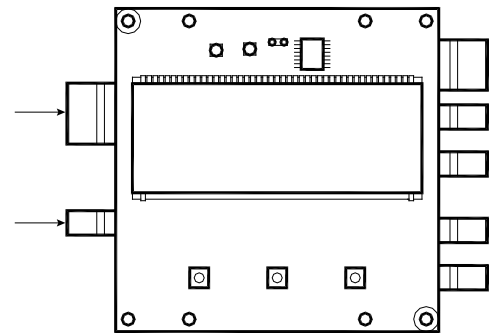

Figure 29: Cables to plugs

##### Connection on the detector

1. Loosen fixing screws of the connection cover and remove cover.
2. Push both cables through two different cable glands.
3. The cable entry should be done as shown in [Figure 30](#).

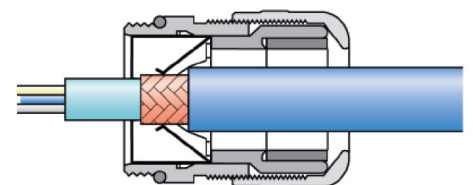

Figure 30: Cable entry

4. Connect the cables to the corresponding plugs on the left side of the board as shown in [Figure 31](#).
5. Close junction box cover again firmly.

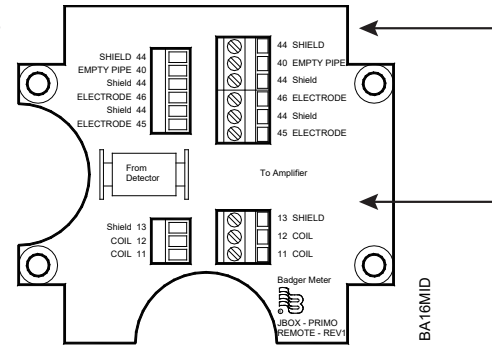

Figure 31: Cables to plugs

### Wiring for Remote Configuration

Remote style M5000 amplifier models can be ordered with standard cables measuring 15, 30, 50 and 100 feet (5, 10, 15, and 30 m).

Junction Box			
Terminal		Description	Wire Color
11	C1	Coil C1	Brown
12	C2	Coil C2	White
13		N/A	Not Used
40	EP	Empty pipe detection	Red
44*	⏏	Shielding electrode	—
44*	⏏	Shielding electrode	Green
45	E1	Electrode E1	White
46	E2	Electrode E2	Black

\*Connections with number 44 are on the same potential.

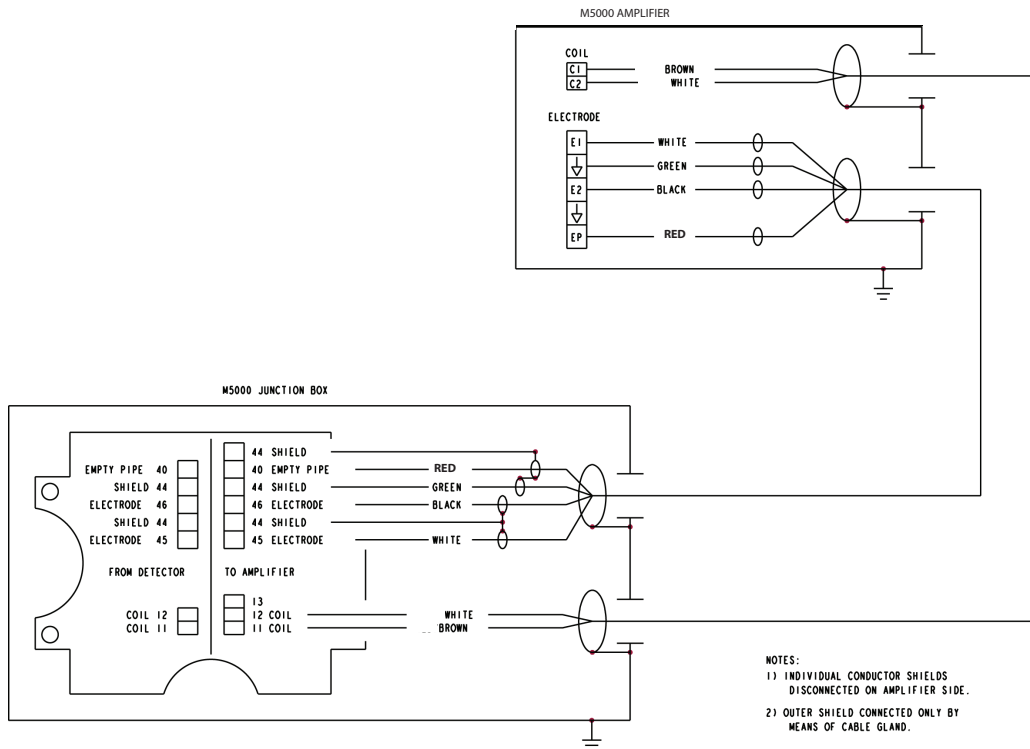
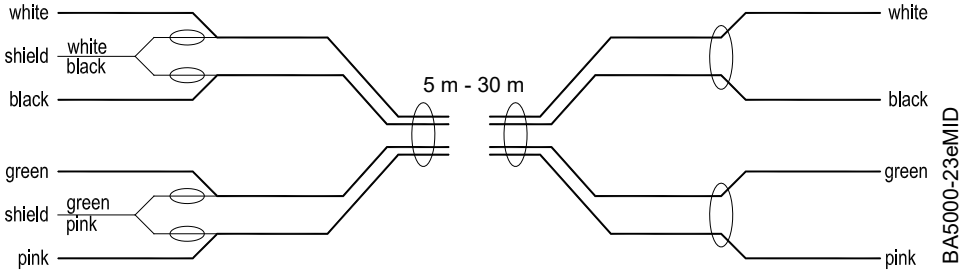

Figure 32: Wiring for remote configuration

### Signal Cable Specification

- Only use signal cables delivered by Badger Meter or corresponding cable in accordance with the following specification.
- Take maximum signal cable length between detector and amplifier into account (keep distance as low as possible).

Electrode Cable		
Distance	Type	Capacity
Maximum 30 m	RGB DY 5 × Kx 0.4/1.8	60 nF/km
Temperature range -10 bis +80° C		



Coil Cable		
Distance	Type	Resistance
Maximum 30 m	1 × (2 × 0.34 mm <sup>2</sup> )	< 115 Ω/km
PVC cable Typ Li2YCY (TP)		
Temperature range -5 bis +70° C		

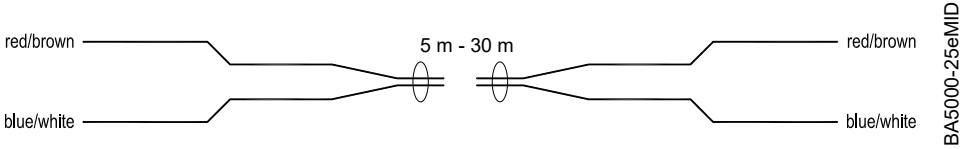

## CONFIGURING INPUT/OUTPUT (I/O)

This section describes wiring the following M5000 outputs:

- Digital outputs
- Communication

When the sensor and the amplifier have been wired, wire any outputs to the M5000 amplifier.

Follow all of the safety precautions and local code to prevent electrical shock and damage to the electronic components.

### Circuit Board Diagram

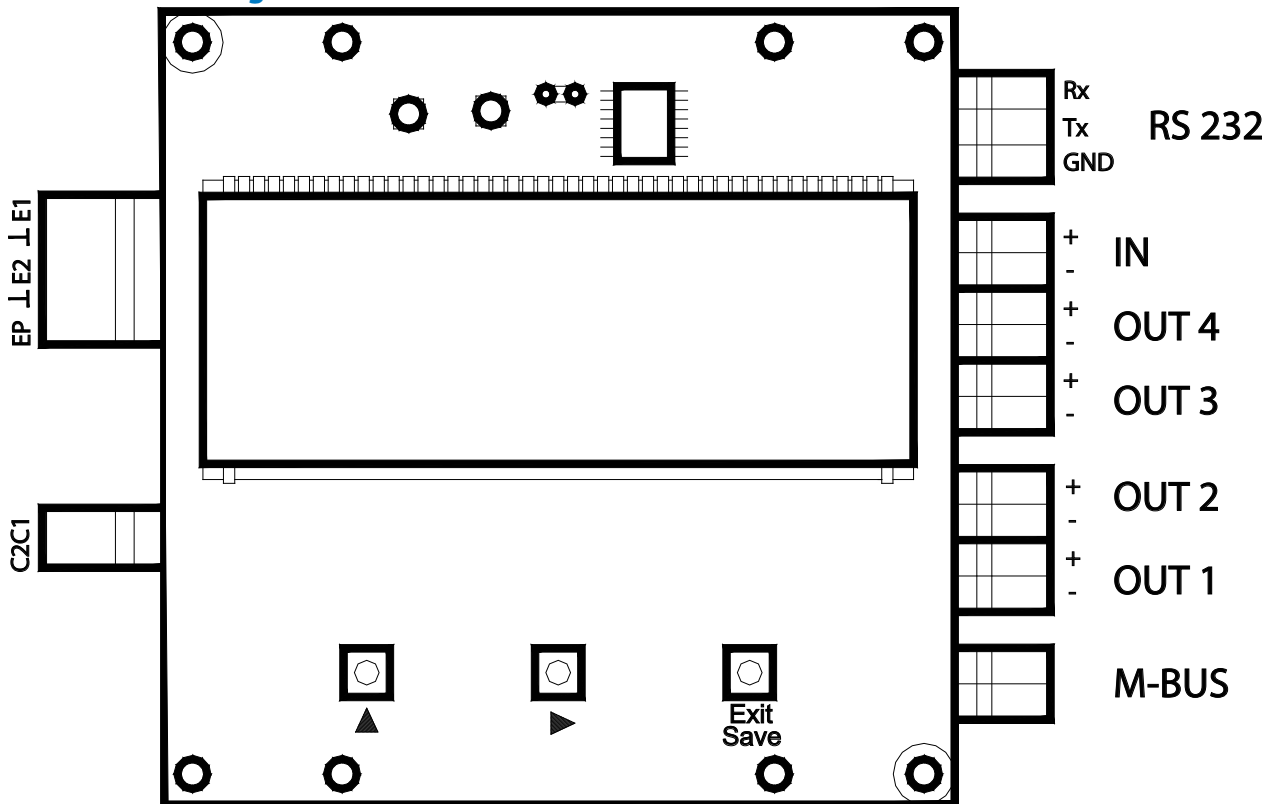

Figure 33: Configuring input/output

Input/Output	Description	Terminal
Output 1	Passive maximum 30V DC, 20 mA Maximum frequency 100 Hz	OUT1 (+) and (-)
Output 2	Passive maximum 30V DC, 20 mA Maximum frequency 100 Hz	OUT2 (+) and (-)
Output 3	Passive maximum 30V DC, 20 mA Maximum frequency 100 Hz	OUT3 (+) and (-)
Output 4	Passive maximum 30V DC, 20 mA Maximum frequency 100 Hz Can be used with digital input as an ADE interface.	OUT4 (+) and (-)
RS232	Modbus RTU	RxD, TxD, GND
IN	Digital input 3...35V DC	IN (+) and (-)
M-Bus	M-Bus interface	No polarity

**NOTE:** The M5000 meter also supports Modbus RTU RS485 communication. Modbus RTU communication options must be selected at time of order or can be ordered as a service part. See the "M5000 Modbus Communication Protocol Memory Map Application Data Sheet", available at [www.badgermeter.com](http://www.badgermeter.com).

### Jumper Location

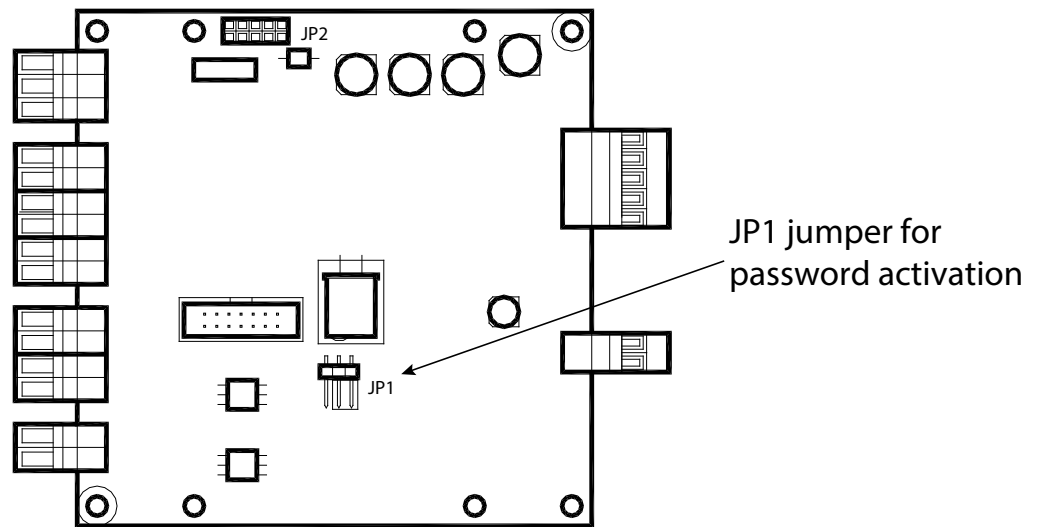

Figure 34: JP1 location

### Digital Output Wiring Diagrams

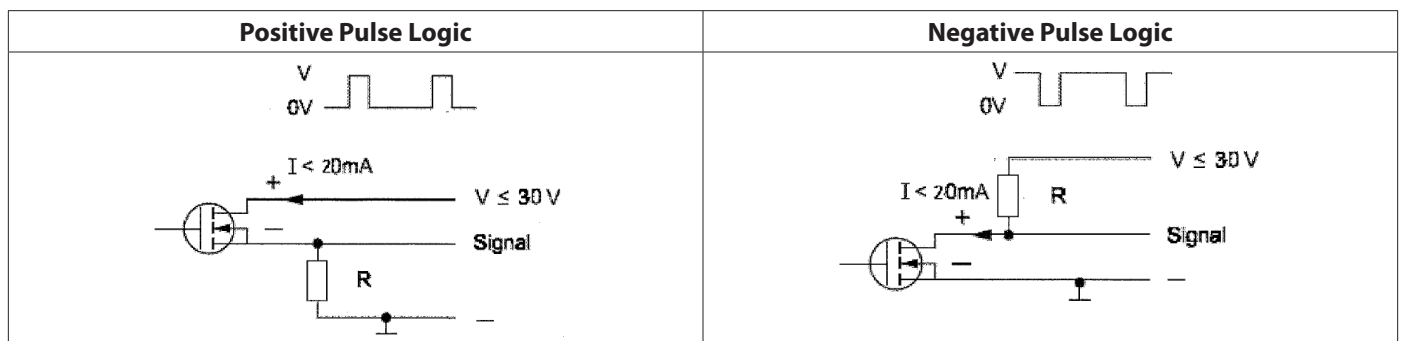

Figure 35: Digital output wiring diagram

### Digital Output Selections

Output 1	Output 2	Output 3	Output 4
Forward Pulse Output	Reverse Pulse Output	Flow direction (Forward vs. Reverse)	ADE
Flow Setpoint (0...100% of full scale, resolution 1%)		Flow Setpoint (0...100% of full scale, resolution 1%)	
Empty pipe alarm		Empty pipe alarm	
Error alarm		Error alarm	
Off			
Test			
Can be used with AMR when the pulse width is set to 50 milliseconds.		—	

Outputs are configurable for Pulses/Unit (PPU) and Pulse Width (PW). The PW is configurable from 5...500 milliseconds, with a frequency limit of 100 Hz. PPU displays using an automatically selected resolution.

The high/low flow alarm functionality is configurable for maximum and minimum setpoints as a percentage of full-scale flow. Configurable values are settable from 0...100% in 1% increments.

## USER INTERFACE

The M5000 amplifier is pre-programmed from the factory. No additional programming is necessary, however, for special features, the meter can be programmed for specific requirements.

### Function Buttons

All M5000 programming is accomplished using the three function buttons located on the front of the amplifier. Screen navigation and digit and parameter selection is performed by a combination of these three buttons.



The **up-arrow** button allows scrolling through nine menu screens. This button is also used to advance numerical digits to change values, such as frequency, period and EP level as well as toggle on-off conditions and flow directions.

The **right-arrow** button allows digit selection from left to right and allows selecting either the top row of the display or the bottom row (the bottom row is active when flashing).

The **EXIT SAVE** button allows the saving of changed values and conditions, toggling between the upper and lower display lines and returning to a previous menu.

### Access the Programming Menu

To access the measuring mode for parametering, please press the key **up-arrow** button as long as necessary until "Menue" is displayed on the second line.



Select Programming

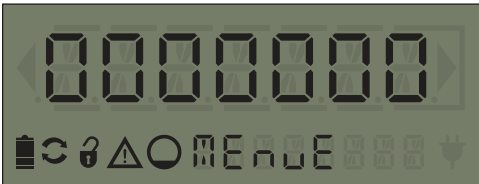

Now press **right-arrow** button to select this menu point.









## Display

The top row displays seven digits for specific values on each screen and the bottom row displays meter and register condition icons and current screen descriptions.





### Icons

-  Battery status
-  Communication interface is activated (RS232, IrDA, M-Bus)
-  Meter is unlocked
-  Error message
-  Empty pipe detection
-  Battery back-up (external power supply)

### Battery Level Indicators

The battery icon indicates three levels of capacity:

-  OK
-  Replacement of battery recommended
-  No measurement

## M5000 MAIN MENU PROGRAMMING OPTIONS

The following M5000 programming options are available from the *Main Menu*:

- *Meter Setup*
- *Measure*
- *In/Out*
- *Communication*
- *Battery*
- *Miscellaneous*
- *Information*
- *Pin*
- *Faults*

The applicable security level for each menu option is indicated as follows:

 Administrative

 Service

 User



Parameters indicated by the battery icon affect battery performance.

### Navigating the Initial Main Screens

From the main display, press **EXIT/SAVE** to go back to the *Flow Rate* screen or press the **UP** arrow to scroll through the following:

Option	Description
Flow screen	Displays flow rate in selected units (for example, Gallons or Cubic Feet)
m/s	Displays flow in meter/second (factory programmed)
Percent	Percent of full scale flow
T1+	Total forward flow (in bidirectional mode)
T1-	Total reverse flow (in bidirectional mode)
T1N	Total net flow (in bidirectional mode)
T2+	Total forward flow (in bidirectional mode, non-resettable)
T2-	Total reverse flow (in bidirectional mode, non-resettable)
T2N	Total net flow (in bidirectional mode, non-resettable)
Login	Login when security is active
Main Menu	Access to Main Menu

## Menu Structure

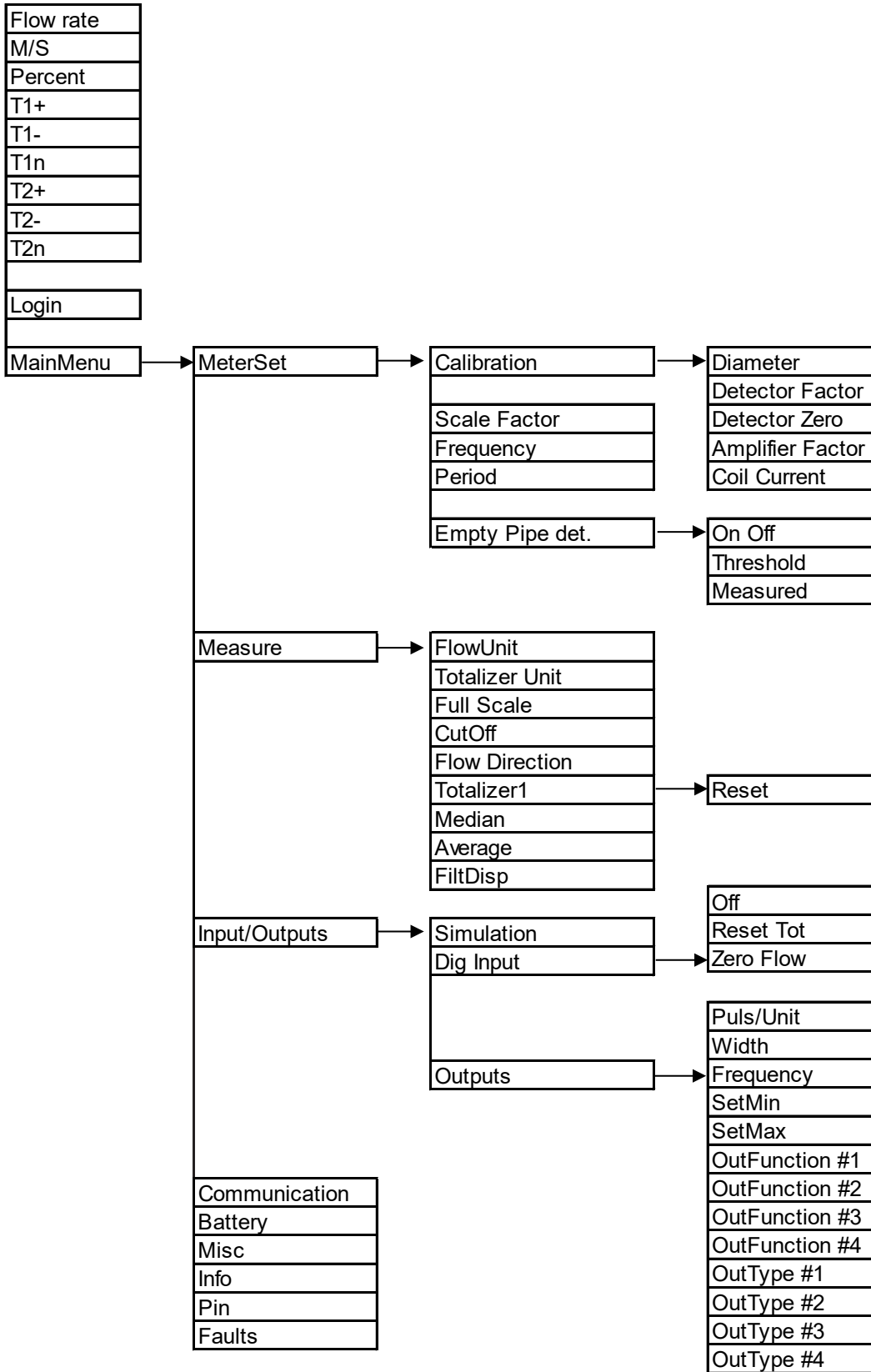

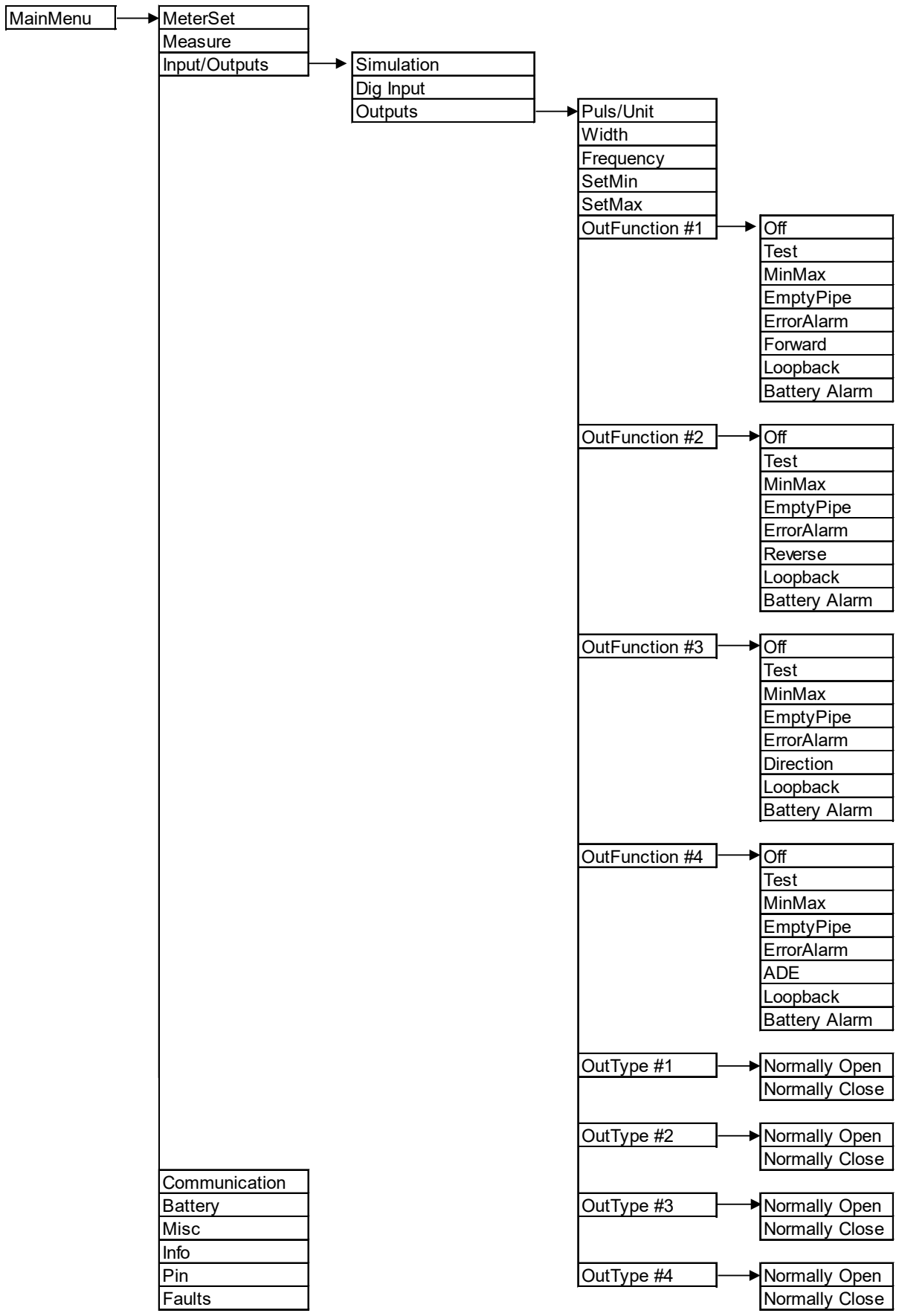

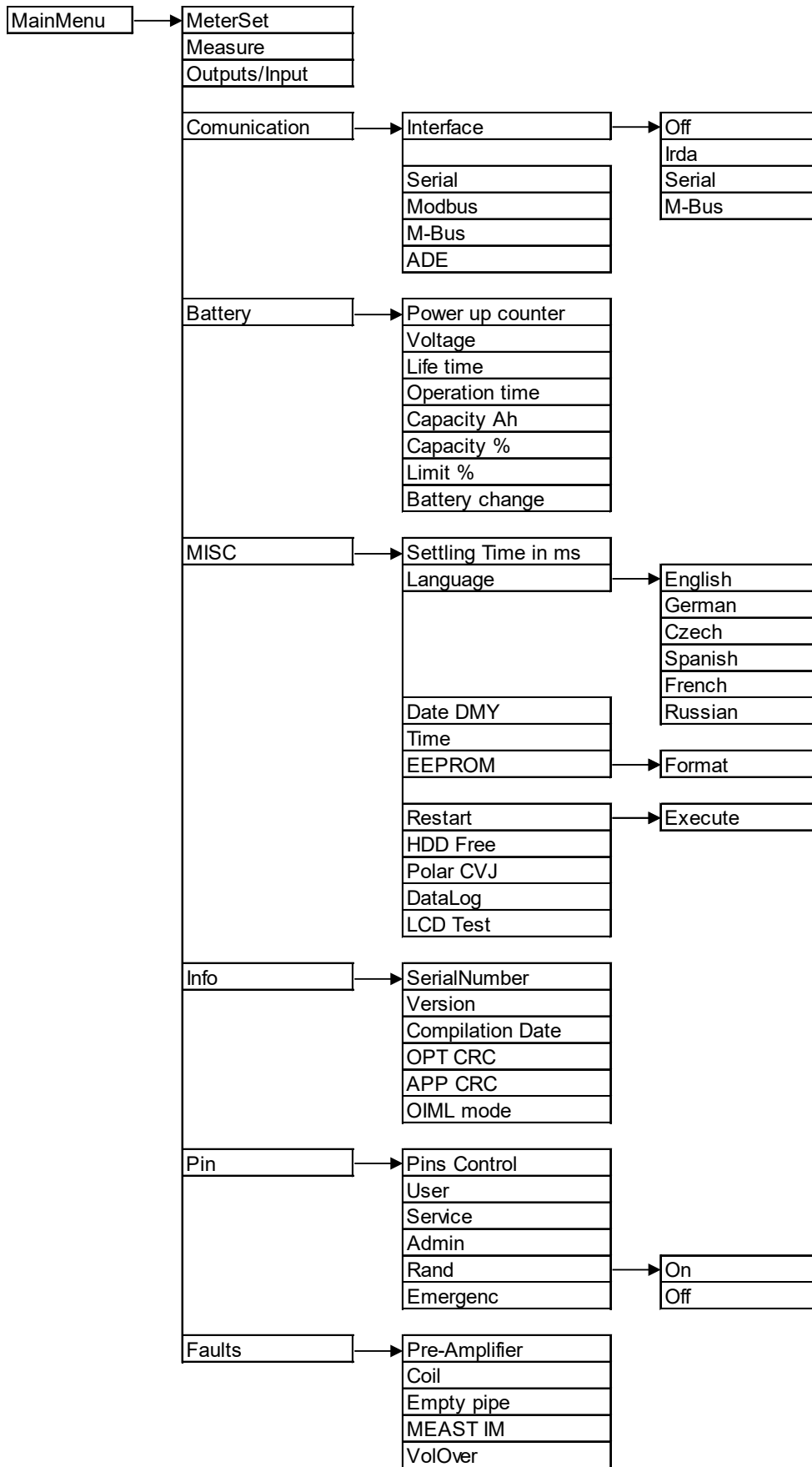















## PROGRAMMING MENUS

### Meter Setup Menu

<b>Meter Setup</b>		
<b>Calibration</b> [Diameter] 	<b>Diameter</b> [Diameter] 	Factory set. In the event the amplifier is replaced, verify that the pipe diameter matches the installed pipe size.
	<b>Detector Factor</b> [Det Fact] 	Factory set. Compensates for accuracy error as a result of the installed detector. In the event the amplifier is replaced, this parameter must be reprogrammed with the original detector factor.
	<b>Detector Zero</b> [Det Zero] 	Factory set. Compensates for accuracy error as a result of the installed detector. In the event the amplifier is replaced, this parameter must be reprogrammed with the original detector zero.
	<b>Amplifier Factor</b> [Amp Fact] Read only	Factory set and Read Only. Compensates for accuracy error as a result of the installed amplifier.
	<b>Coil Current</b> [Coil Cur] Read only	Factory set and Read Only. Compensates for accuracy error as a result of the installed amplifier.
<b>Scale Factor</b> [Scale] 	Changing the scale factor lets you adjust the meter's accuracy without disturbing parameters set by the factory. You can tune the meter to meet changing application requirements. Can be adjusted in the range 0.901...1.0999.	
<b>Power Line Frequency</b> [Freq HZ]	<b>60 Hz</b> 	Provides measuring immunity to industrial noise from a power supply feed. It is factory set to 60 Hz, which is the value used in the US.
	<b>50 Hz</b>	Optional setting. 50 Hz is the value used outside the US.
<b>Period</b> [Period s] 	This parameter configures the frequency to 0...63 seconds of sampled measurements. The adjustment can be done in steps of 1 second. The value 0 is only used for calibration (4 measurements per second). <b>NOTE:</b> Parameters indicated by the battery icon affect battery performance. Standard sampling period is 15 seconds.	
<b>Empty Pipe Detection</b>	<b>Empty Pipe ON/OFF</b> [On Off] 	When set to ON, an Empty Pipe condition indicates to the outputs that the meter is not completely filled. When set to OFF, empty pipe conditions are not detected.
	<b>Threshold</b> [Threshold] 	Factory set and adjusted to the conductivity of normal water.
	<b>Measure</b> [Measure] Read only	Measures the real empty pipe value, Read Only.











## Measure Menu





<b>Measure</b>																																									
<p><b>Flow Unit</b> [Flow Unit]</p> 	<p>Establishes the unit of measure for the flow rate and full scale flow. Changing this parameter readjusts the full scale flow parameter. For example, changing from GPM to GPS would change the full scale flow from 60 gal/min to 1 gal/s.</p> <table border="1" style="width: 100%; border-collapse: collapse;"> <thead> <tr> <th style="text-align: center;"><i>Display</i></th> <th style="text-align: center;"><i>Flow Unit</i></th> <th style="text-align: center;"><i>Display</i></th> <th style="text-align: center;"><i>Flow Unit</i></th> </tr> </thead> <tbody> <tr> <td>LPS</td> <td>Liters/Sec.</td> <td>GPS</td> <td>Gallons/Sec.</td> </tr> <tr> <td>LPM</td> <td>Liters/Min.</td> <td>GPM</td> <td>Gallons/Min.</td> </tr> <tr> <td>LPH</td> <td>Liters/Hour</td> <td>GPH</td> <td>Gallons/Hour</td> </tr> <tr> <td>M3S</td> <td>Cubic Meters/Sec.</td> <td>MGD</td> <td>MillionGallons/Day</td> </tr> <tr> <td>M3M</td> <td>Cubic Meters/Min.</td> <td>IGS</td> <td>ImperialGallons/Sec.</td> </tr> <tr> <td>M3H</td> <td>Cubic Meters/Hour</td> <td>IGM</td> <td>ImperialGallons/Min.</td> </tr> <tr> <td>F3S</td> <td>Cubic Feet/Sec.</td> <td>IGH</td> <td>ImperialGallons/Hour</td> </tr> <tr> <td>F3M</td> <td>Cubic Feet/Min.</td> <td>OPM</td> <td>Ounce/Min.</td> </tr> <tr> <td>F3H</td> <td>Cubic Feet/Hour</td> <td>BPM</td> <td>Barrel/Min.</td> </tr> </tbody> </table>	<i>Display</i>	<i>Flow Unit</i>	<i>Display</i>	<i>Flow Unit</i>	LPS	Liters/Sec.	GPS	Gallons/Sec.	LPM	Liters/Min.	GPM	Gallons/Min.	LPH	Liters/Hour	GPH	Gallons/Hour	M3S	Cubic Meters/Sec.	MGD	MillionGallons/Day	M3M	Cubic Meters/Min.	IGS	ImperialGallons/Sec.	M3H	Cubic Meters/Hour	IGM	ImperialGallons/Min.	F3S	Cubic Feet/Sec.	IGH	ImperialGallons/Hour	F3M	Cubic Feet/Min.	OPM	Ounce/Min.	F3H	Cubic Feet/Hour	BPM	Barrel/Min.
<i>Display</i>	<i>Flow Unit</i>	<i>Display</i>	<i>Flow Unit</i>																																						
LPS	Liters/Sec.	GPS	Gallons/Sec.																																						
LPM	Liters/Min.	GPM	Gallons/Min.																																						
LPH	Liters/Hour	GPH	Gallons/Hour																																						
M3S	Cubic Meters/Sec.	MGD	MillionGallons/Day																																						
M3M	Cubic Meters/Min.	IGS	ImperialGallons/Sec.																																						
M3H	Cubic Meters/Hour	IGM	ImperialGallons/Min.																																						
F3S	Cubic Feet/Sec.	IGH	ImperialGallons/Hour																																						
F3M	Cubic Feet/Min.	OPM	Ounce/Min.																																						
F3H	Cubic Feet/Hour	BPM	Barrel/Min.																																						
<p><b>Totalizer Unit</b> [Tot Unit]</p> 	<p>Establishes the units of measure for the totalizers.</p> <table border="1" style="width: 100%; border-collapse: collapse;"> <thead> <tr> <th style="text-align: center;"><i>Display</i></th> <th style="text-align: center;"><i>Totalizer Unit</i></th> </tr> </thead> <tbody> <tr> <td>L</td> <td>Liters</td> </tr> <tr> <td>HL</td> <td>Hectoliter</td> </tr> <tr> <td>M^3</td> <td>Cubic Meters</td> </tr> <tr> <td>CFt</td> <td>Cubic Feet</td> </tr> <tr> <td>USG</td> <td>US Gallons</td> </tr> <tr> <td>MG</td> <td>Million Gallons</td> </tr> <tr> <td>UKG</td> <td>Imperial Gallons</td> </tr> <tr> <td>Oz</td> <td>Fluid Ounces</td> </tr> <tr> <td>Aft</td> <td>Acre foot</td> </tr> <tr> <td>BBL</td> <td>Barrel (42 gallons)</td> </tr> </tbody> </table>	<i>Display</i>	<i>Totalizer Unit</i>	L	Liters	HL	Hectoliter	M^3	Cubic Meters	CFt	Cubic Feet	USG	US Gallons	MG	Million Gallons	UKG	Imperial Gallons	Oz	Fluid Ounces	Aft	Acre foot	BBL	Barrel (42 gallons)																		
<i>Display</i>	<i>Totalizer Unit</i>																																								
L	Liters																																								
HL	Hectoliter																																								
M^3	Cubic Meters																																								
CFt	Cubic Feet																																								
USG	US Gallons																																								
MG	Million Gallons																																								
UKG	Imperial Gallons																																								
Oz	Fluid Ounces																																								
Aft	Acre foot																																								
BBL	Barrel (42 gallons)																																								
<p><b>Full Scale Flow</b> [Full Sca]</p> 	<p>Sets the maximum flow the system is expected to measure. Influences other system parameters, including:</p> <ul style="list-style-type: none"> <li>• Low Flow Cutoff – Changes to full scale flow affect the measuring cut-off threshold of the meter</li> <li>• Alarm Outputs – Changes to full scale flow adjusts the thresholds for generating setpoint alarms</li> <li>• Pulse Outputs – Changes to full scale flow adjusts the pulse frequency and duty cycle</li> </ul> <p>Change the full scale flow based on the meter size and the application's requirements. Verify that the full scale flow falls within the meter's suggested flow range limits. Flow Range: 0.1...32.8 ft/s (0.03...10 m/s) The full scale flow is valid for both flow directions.</p> <p><b>NOTE:</b> If the flow rate exceeds the full scale setting by more than 25%, a FLOW_OVERLOAD_WARNING message indicates that the configured full scale range has been exceeded. The meter continues to measure. This affects the latency of the pulse outputs and may cause overflow.</p>																																								
<p><b>Low Flow Cutoff</b> [Cut Off]</p> 	<p>Defines the threshold at which flow measurement is forced to zero. The cutoff value can be set from 0...9.9% of the full scale flow. Increasing this threshold helps prevent false readings during "no flow" conditions possibly caused by pipe vibration or inherent system noise.</p>																																								

<b>Measure</b>	
<p><b>Flow Direction</b> [Bi-directional]</p> 	<p>Allows setting the meter to measure forward flow only (unidirectional) or both forward and reverse flow (bidirectional).</p> <p><b>Unidirectional</b> Flow is totalized in only one direction. The flow direction is indicated by the arrow printed on the detector label. Unidirectional measurements on the main display screen include: T1: Registers forward flow, resettable by menu or Modbus RTU. T2: Registers forward flow, non-resettable.</p> <p><b>Bidirectional</b> Flow is totalized in both directions. A change of flow direction can be indicated by the digital output. Bidirectional measurements on the main display screen include: T1+: Registers forward flow, resettable by menu or Modbus RTU T1-: Registers reverse flow, resettable by menu or Modbus RTU T1N: Registers total flow, T+ - T-, resettable by menu or Modbus RTU T2+: Registers forward flow, non-resettable T2-: Registers reverse flow, non-resettable T2N: Registers total flow, T+ - T-, non-resettable</p>
<p><b>T1 Reset</b> [T1]</p> 	<p>Allows the reset of totalizer T1.</p> <p><b>NOTE:</b> If the meter is used as a water meter according the European directive 2004/22/EC (MID MI-001) or OIML R49, then the totalizer T1 is non-resettable.</p>
<p><b>Median</b> [Median]</p>	<p>Can be set to ON or OFF. When set to ON, the median display filters out the flow rate fluctuations displayed on the LCD.</p>
<p><b>Average</b> [Average]</p>	<p>Known as a measurement averaging filter. The user can select how many flow rate measurements to be averaged together to calculate the current flow rate value. Dampens the rate of change of the flow rate. Moving average filter (MAV) smooth out short-term fluctuations. The value can be adjusted from 1 to 20 measuring periods.</p> <p>The delay is calculated: <math>\text{Delay [s]} = \text{MAV} \times T</math> The time T is given by the adjusted excitation frequency (period) of the meter. For example MAV = 2 and the excitation frequency (period) is T = 5 s means a delay of 10 s.</p>
<p><b>Filter Display</b> [FiltDisp]</p>	<p>Can be set from 0...99 seconds. The display updates less frequently, depending on how high the filter display is set.</p>







## Inputs/Outputs Menu



<b>Inputs/Outputs</b>							
<b>Flow Simulation</b> [Simulat] 	Provides output simulation based on a percentage of the full scale flow. Simulation does not accumulate the totalizers. The range of simulation includes –100...100% of the full scale flow. The parameter lets you set the range of simulation in increments of 50 (OFF, 0, 50, 100, –50, –100). The factory default is OFF.						
<b>Digital Input</b> [Input] 	<ul style="list-style-type: none"> <li>• Allows you to reset the T1 totalizer or interrupt flow measurement. Only the T1 can be reset.</li> <li>• Input switching is provided by applying an external voltage of 3...35V DC.</li> <li>• Use a “normally open” contact for operating.</li> </ul>						
<b>Digital Outputs</b> [Outputs] <i>(continued on next page)</i>	<table border="1" style="width: 100%; border-collapse: collapse;"> <tr> <td style="width: 15%; vertical-align: top;"> <b>Pulse/Unit</b>   </td> <td>                     Allows you to set how many pulses per unit of measure to transmit to remote applications. For example, assuming the unit of measure is gallons:                     <ul style="list-style-type: none"> <li>• Setting the Pulses/Unit to 1 (standard setting) transmits 1 pulse every gallon</li> <li>• Setting the Pulses/Unit to 0.01 transmits 1 pulse every 100 gallons</li> </ul>                     You must configure Pulses/Unit if the function of the selected output is to be forward or reverse .                      The parameter must be considered with the Pulse Width and Full Scale Flow parameters. The maximum pulse frequency is 100 Hz. The frequency is correlated with the flow rate. Violation of output frequency limits generates a PULSE_OVERLOAD_WARNING.                 </td> </tr> <tr> <td style="vertical-align: top;"> <b>Width</b>   </td> <td>                     Establishes the ON duration of the transmitted pulse. The configurable range is 0...500 ms. The factory default is 0 ms.                     <ul style="list-style-type: none"> <li>• Non-zero pulse width configuration – the OFF duration of the transmitted pulse is dependent on flow rate. The OFF duration is to be at least the configured ON duration. At full scale flow, the ON duration equals the Off duration. The maximum configurable output frequency is limited to 100 Hz.</li> <li>• The duty cycle of the transmitted pulse is at 50% of the output frequencies greater than 1 Hz.</li> </ul>                     The parameter must be considered with the Pulses/Unit and Full Scale Flow parameters. The maximum pulse frequency is 100 Hz. The frequency is correlated with the flow rate. Violation of output frequency limits generates a PULSE_OVERLOAD_WARNING.                 </td> </tr> <tr> <td style="vertical-align: top;"> <b>Power Line Frequency</b>   </td> <td>                     Provides measuring immunity to industrial noise from a power supply feed. Set the parameter to your nominal line frequency, typically 60 Hz.                 </td> </tr> </table>	<b>Pulse/Unit</b> 	Allows you to set how many pulses per unit of measure to transmit to remote applications. For example, assuming the unit of measure is gallons: <ul style="list-style-type: none"> <li>• Setting the Pulses/Unit to 1 (standard setting) transmits 1 pulse every gallon</li> <li>• Setting the Pulses/Unit to 0.01 transmits 1 pulse every 100 gallons</li> </ul> You must configure Pulses/Unit if the function of the selected output is to be forward or reverse . The parameter must be considered with the Pulse Width and Full Scale Flow parameters. The maximum pulse frequency is 100 Hz. The frequency is correlated with the flow rate. Violation of output frequency limits generates a PULSE_OVERLOAD_WARNING.	<b>Width</b> 	Establishes the ON duration of the transmitted pulse. The configurable range is 0...500 ms. The factory default is 0 ms. <ul style="list-style-type: none"> <li>• Non-zero pulse width configuration – the OFF duration of the transmitted pulse is dependent on flow rate. The OFF duration is to be at least the configured ON duration. At full scale flow, the ON duration equals the Off duration. The maximum configurable output frequency is limited to 100 Hz.</li> <li>• The duty cycle of the transmitted pulse is at 50% of the output frequencies greater than 1 Hz.</li> </ul> The parameter must be considered with the Pulses/Unit and Full Scale Flow parameters. The maximum pulse frequency is 100 Hz. The frequency is correlated with the flow rate. Violation of output frequency limits generates a PULSE_OVERLOAD_WARNING.	<b>Power Line Frequency</b> 	Provides measuring immunity to industrial noise from a power supply feed. Set the parameter to your nominal line frequency, typically 60 Hz.
<b>Pulse/Unit</b> 	Allows you to set how many pulses per unit of measure to transmit to remote applications. For example, assuming the unit of measure is gallons: <ul style="list-style-type: none"> <li>• Setting the Pulses/Unit to 1 (standard setting) transmits 1 pulse every gallon</li> <li>• Setting the Pulses/Unit to 0.01 transmits 1 pulse every 100 gallons</li> </ul> You must configure Pulses/Unit if the function of the selected output is to be forward or reverse . The parameter must be considered with the Pulse Width and Full Scale Flow parameters. The maximum pulse frequency is 100 Hz. The frequency is correlated with the flow rate. Violation of output frequency limits generates a PULSE_OVERLOAD_WARNING.						
<b>Width</b> 	Establishes the ON duration of the transmitted pulse. The configurable range is 0...500 ms. The factory default is 0 ms. <ul style="list-style-type: none"> <li>• Non-zero pulse width configuration – the OFF duration of the transmitted pulse is dependent on flow rate. The OFF duration is to be at least the configured ON duration. At full scale flow, the ON duration equals the Off duration. The maximum configurable output frequency is limited to 100 Hz.</li> <li>• The duty cycle of the transmitted pulse is at 50% of the output frequencies greater than 1 Hz.</li> </ul> The parameter must be considered with the Pulses/Unit and Full Scale Flow parameters. The maximum pulse frequency is 100 Hz. The frequency is correlated with the flow rate. Violation of output frequency limits generates a PULSE_OVERLOAD_WARNING.						
<b>Power Line Frequency</b> 	Provides measuring immunity to industrial noise from a power supply feed. Set the parameter to your nominal line frequency, typically 60 Hz.						

<b>Inputs/Outputs</b>																																																				
<b>Digital Outputs</b> <i>(continued)</i>	<b>Set Minimum</b> [Set Min] 	Establishes, as a percentage of full scale flow, the threshold at which the output alarm is activated. Flow rates below the threshold activate the output alarm.																																																		
	<b>Set Maximum</b> [Set Max] 	Establishes, as a percentage of full scale flow, the threshold at which the output alarm is activated. Flow rates above the threshold activate the output alarm.																																																		
	<b>Function</b> [Out 1 Func] [Out 2 Func] [Out 3 Func] [Out 4 Func] 	Provides configuration of the functional operation of the associated output. The following operations are supported: <table border="1" style="margin: 10px auto; width: 80%; border-collapse: collapse;"> <thead> <tr> <th>Function</th> <th>Dig1</th> <th>Dig2</th> <th>Dig3</th> <th>Dig4</th> </tr> </thead> <tbody> <tr> <td>Off</td> <td>X</td> <td>X</td> <td>X</td> <td></td> </tr> <tr> <td>Test</td> <td>X</td> <td>X</td> <td>X</td> <td></td> </tr> <tr> <td>MinMax</td> <td>X</td> <td>X</td> <td>X</td> <td></td> </tr> <tr> <td>Empty</td> <td>X</td> <td>X</td> <td>X</td> <td></td> </tr> <tr> <td>ErAlarm</td> <td>X</td> <td>X</td> <td>X</td> <td></td> </tr> <tr> <td>Forward</td> <td>X</td> <td></td> <td></td> <td></td> </tr> <tr> <td>Reverse</td> <td></td> <td>X</td> <td></td> <td></td> </tr> <tr> <td>Direct</td> <td></td> <td></td> <td>X</td> <td></td> </tr> <tr> <td>ADE</td> <td></td> <td></td> <td></td> <td>X</td> </tr> </tbody> </table> <ul style="list-style-type: none"> <li>Inactive [Off] means digital output is switched off. It is recommended to switch off the outputs in the menu "Output function" if not used. This increases the battery life time.</li> <li>Test [Test] triggers the output.</li> <li>Flow setpoint [MinMax] provides indication when flow rate exceeds thresholds defined by flow setpoints (set min, set max).</li> <li>Empty pipe alarm [Empty] provides indication when pipe is empty.</li> <li>Error alarm [ErAlarm] provides indication when meter has error condition.</li> <li>Forward pulse [Forward] generates pulses during forward flow conditions.</li> <li>Reverse pulse [Reverse] generates pulses during reverse flow conditions.</li> <li>Flow direction [Direct] provides indication on current flow direction.</li> <li>ADE [ADE] "Absolute Digital Encoder" for remote meter reading using ASCII communication protocol.</li> </ul>	Function	Dig1	Dig2	Dig3	Dig4	Off	X	X	X		Test	X	X	X		MinMax	X	X	X		Empty	X	X	X		ErAlarm	X	X	X		Forward	X				Reverse		X			Direct			X		ADE				X
	Function	Dig1	Dig2	Dig3	Dig4																																															
Off	X	X	X																																																	
Test	X	X	X																																																	
MinMax	X	X	X																																																	
Empty	X	X	X																																																	
ErAlarm	X	X	X																																																	
Forward	X																																																			
Reverse		X																																																		
Direct			X																																																	
ADE				X																																																
<b>Output Mode</b> [Out 1 Type] [Out 2 Type] [Out 3 Type] [Out 4 Type] 	Allows you to set the output switch to normally open or normally closed. If normally open is selected, the output switch is open (no current) when the output is inactive, and closed (current flows) when the output is active. If normally closed is selected, the output switch is closed (current flows) when the output is inactive, and open (no current) when the output is active.																																																			







## Communication Menu

Communication: Port Settings		
<b>Interface</b> [Interface] 	Provides communication port configuration. <ul style="list-style-type: none"> <li>• IrDA (Modbus RTU)</li> <li>• Serial (Modbus RTU)</li> </ul> <b>NOTE:</b> Modbus RTU is only for programming the meter or reading the internal data logger. Extended use, even in standby mode, uses power and can drain the battery quickly. <ul style="list-style-type: none"> <li>• M-Bus</li> <li>• OFF (turns off the serial interfaces). Serial interfaces left ON shorten the battery life.</li> </ul>	
<b>Serial</b> [Serial]	<b>Baud Rate</b> [Baudrate] 	Sets the baud rate. The following baud rates are supported: <ul style="list-style-type: none"> <li>• 9600 (Default)</li> <li>• 1200</li> <li>• 2400</li> </ul>
	<b>Parity</b> [Parity] 	Sets the parity. The following parities are supported: <ul style="list-style-type: none"> <li>• Even (Default)</li> <li>• Odd</li> <li>• Mark</li> </ul>
<b>Modbus</b> [Modbus]	<b>Address</b> 	Configures the Modbus address in the range of 1...247. See the "M-5000 Modbus Communication Protocol Memory Map" application data sheet (available at <a href="http://www.badgermeter.com">www.badgermeter.com</a> ) for Modbus register information.
<b>M-Bus</b> [M-Bus]	<b>Address</b> 	Configures the M-Bus® address in the range of 1...247.
<b>ADE</b>	<b>Control</b>	ON/OFF
	<b>Protocol</b> [Protocol]	V1 standard messages V2 extended messages
	<b>Dial</b> [Dial]	4...9
	<b>Resolution</b> [Resolution]	0.0001...10000

## Battery Menu

<b>PwrUpCnt</b> (Read Only)	(Power Up Counter) A diagnostic counter of how many times the meter has reset or been power cycled (for instance, battery removed and replaced).	
<b>Voltage</b> (Read Only)	Displays the current battery voltage.	
<b>Lifetime</b> (Read Only)	Displays the remaining battery life time in years depending on the currently selected parameters. <b>NOTE:</b> Battery life time is mainly influenced by the excitation frequency (period) and selected communication interfaces.	
<b>OnTime</b> (Read Only)	Diagnostic that refers to the amount of time the meter has been powered in terms of hours.	
<b>Capacity</b> [Bat Ah] (Read Only)	Displays the current battery capacity in Amp hours or Percent. <b>NOTE:</b> A new battery should be at or near maximum capacity.	
<b>Limit</b> 	<b>Options: 5, 10, 15, 20, 25, 30, OFF</b>	Sets the battery capacity remaining threshold that generates an output alarm when the remaining battery capacity drops below the threshold. Set to <i>OFF</i> if output alarm is not needed.
<b>Change</b> 	<b>Options: 19, 38, 70, Ah</b>	Allows the user to change the battery through a controlled process. The user selects the new battery pack capacity and then is required to replace the battery. While in entry mode, exit from this menu item is prohibited until after the battery is replaced. Additionally, this is the required process to save necessary measurement data to non-volatile memory while also resetting all battery configuration and diagnostic data (such as lifetime, capacity remaining, saved totalizers).

## Miscellaneous Menu

<b>Misc</b>	
<b>Settling</b> [Read Only]	The time the magnetic circuit takes to settle. An engineering diagnostic.
<b>Language</b> [Language]  <b>U</b>	Allows you to change the current language. English is the default setting. The following languages are supported: German (Deutsch), Czech (Cestina), Spanish (Español), French (Français), Russian (Россия), Italian (Italiano).
<b>Date</b> [Date DMY] [Read Only]  <b>S</b>	Real-time calendar. The day, month and year must be reprogrammed after the battery is replaced or powered off.
<b>Time</b> [Time]  <b>S</b>	Real-time clock. The hour, minute and second must be reprogrammed after the battery is replaced or powered off.
<b>EEPROM</b> [EEPROM]  <b>A</b>	Format the EEPROM to erase all log files. Totalizers and configuration remain unaffected during a format.
<b>Battery</b> [Battery]  <b>S</b>	Saves Totalizers to nonvolatile memory in preparation for battery replacement.
<b>Restart</b> [Restart]  <b>S</b>	Provides the ability to reset the meter electronics.
<b>HDD Free</b> [HDD Free] (Read only)  <b>S</b>	Indicates the amount of free flash memory space.
<b>Polarity</b> [Polar V] (Read only)	Measured electrode polarizing voltage (for service purposes).
<b>Datalogger</b> [DataLog]	The logging period can be adjusted to the following values: 1 min / 15 min / 1 h / 6 h / 12 h / 24 h. See the <i>Datalogging User Manual</i> for more information.
<b>LCD Test</b> [LCD Test]	After pressing <b>E</b> , all display segments appear for about 2 seconds.

## Information Menu

Info	
<b>Serial Number</b> [SerNum] (Read Only)	Serial number of the electronic board.
<b>Software Version</b> [Version] (Read Only)	Software version of the device.
<b>Compilation Date</b> [Compilat] (Read Only)	Date of the software version.
<b>OPT CRC</b> [OPT CRC] (Read Only)	Checksum of the software update.
<b>APP CRC</b> [APP CRC] (Read Only)	Checksum of the application.
<b>OIML Mode</b> [OIML mode] (Read Only)	If the meter is used as a water meter according to OIML R49 or MID, the mode has to be ON. In this case, all parameters are "read only".

## Faults Menu

Faults	
<b>Preamp</b>	The Faults menu displays the errors and the number of times they have occurred each hour. For an explanation of the error or how to fix it, see <a href="#">"Errors and Warnings" on page 43</a> .
<b>Coil</b>	
<b>Empty Pipe</b>	
<b>Measure Time</b>	
<b>Volume Overflow</b>	

## SECURITY

The M5000 security feature allows the option to restrict access to the meter by way of a 6-digit Personal Identification Number (PIN). The default password is 000000 if no other password is entered. Not all levels of access need to be set. If no PINs are set, any M5000 user has access to all functions but cannot change parameters.

**NOTE:** If the meter is used as a water meter according to the European directive 2004/22/EC (MID MI-001) or OIML R49, all parameters are locked and only readable. In this case, the password feature is not feasible.

### IMPORTANT

A new M5000 meter comes from the factory with the Security feature jumper on the underside of the electronics board in the *INACTIVE* position (with the jumper shorting the center and right pins). After you set a PIN, move the jumper to the *ACTIVE* position (with the jumper shorting the center and left pins) so you can use the Security functions. See the illustrations under "[Activating the Security Feature](#)" below. If you set a PIN for the Administration mode and then later decide you also need to set a User or Service pin, first move the jumper back to the *INACTIVE* position, then set another pin, then move it back to the *ACTIVE* position.

The system administrator can set up a single PIN for each of the three different levels of access:

- **Administration** – allows access to all M5000 menu configuration screens.
- **Service** – allows access to service-level and user-level menu configuration screens.
- **User** – allows access only to user-level menu configuration screens.

**NOTE:** For a lost PIN, contact Badger Meter Technical Support at 800-456-5023.

The security settings also apply to remote access. All remote writes via Modbus to the meter are blocked unless the user is remotely logged in.

### Setting a PIN

1. From the *Main Menu*, press the **right-arrow** button.
2. From the *Meter Setup* menu, press the **up-arrow** button until the *Pin* menu is displayed.
3. Press the **right-arrow** button to display the *PINS Control* menu.
4. Press the **right-arrow** button to flash ON or OFF.
5. With either ON or OFF flashing, press the **up-arrow** button to display ON.
6. Press the **EXIT SAVE** button to save the ON setting.
7. With the *Control* menu flashing, press the **up-arrow** button to display the desired security level (user, service, or admin).
8. With the desired security level flashing, press the **right-arrow** button to display the upper row of six zeros (digits).
9. Press the **up-arrow** button to change the first digit, followed by pressing the **right-arrow** button to select the next digit.
10. Press the **EXIT SAVE** button to save the PIN number for that security level.

### Activating the Security Feature

1. Unscrew and open the enclosure cover.
2. Unscrew and remove the 4 screws holding the circuit board.
3. Flip the circuit board so the back side faces up.
4. Locate the jumper at the bottom center of the board.
5. Move the jumper from the *INACTIVE* position (shorting the center and right pins) to the *ACTIVE* position (shorting the center and left pins).
6. Flip the circuit board so it faces up.
7. Secure the circuit board with 4 screws.
8. Close the enclosure cover and tighten the 4 screws.

The saved PIN number is the same PIN number used to log in to the amplifier.

**NOTE:** Be sure to log off when you have completed work with the M5000. Otherwise, a five-minute time delay occurs between the most recent activity and the time when the M5000 automatically logs off.

**INACTIVE  
Position**

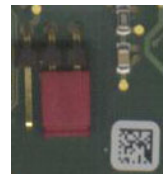

**ACTIVE  
Position**

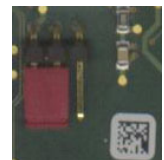

## Logging In





To change any parameter in the mag meter, the PIN entered must provide the proper security privilege required by the parameter.

To enter a PIN, go to the *Login* menu and enter the PIN for the required security level. Once you are properly logged in, the unlocked icon appears on the meter display. A **PIN Error** message displays if the incorrect PIN is entered.

## Logging Out

To log out, follow steps 1 through 8 under "*Setting a PIN*". At step 9, enter an invalid PIN, then press **EXIT SAVE**.

## PIN Menu

PIN	
<b>Control</b> 	Two options are available: <ul style="list-style-type: none"> <li>• ON (requires PIN configuration)</li> <li>• OFF</li> </ul>
<b>User</b> 	Users logged in with this PIN have access to all user levels. Users at this level do not have access to Service or Admin functions.
<b>Service</b> 	Users logged in with this PIN have access to both service and user-level procedures. Users at this level do not have access to Admin functions.
<b>Admin</b> 	Users logged in with this PIN have access to all procedures. Users at this level have full access to the meter.
<b>Random</b>	Generates a random number which is used when a PIN is lost. This number is needed for Badger Meter Tech Support to provide a Master PIN.
<b>Emergency</b>	Enter the Master PIN received from Badger Meter Technical Support to unlock the meter in case the Admin PIN has been lost.



## MAINTENANCE

Mandatory, routine or scheduled maintenance should not be required for the M5000 Electromagnetic Flow Meter electronics or flow tube after proper installation.

However, some occurrences may require personnel to perform the following:

- Flow tube and electrode cleaning
- Circuit board replacement

### **⚠ WARNING**

**DO NOT CLEAN COMPONENTS INSIDE THE AMPLIFIER OR JUNCTION BOX.**

### Cleaning the Flow Tube and Electrode

At times flow tube, electrodes, amplifier/junction box housings and the amplifier window may need cleaning, depending on process fluid properties, fluid flow rate and surrounding environment.

Clean the flow tube and electrodes by following the material handling and cleaning procedures documented in the Material Safety Data Sheet (MSDS) guidelines for the product(s) that were in contact with the flow tube and electrodes.

Should flow tube and/or electrode cleaning become necessary:

1. Disconnect detector from pipeline.
2. Clean electrodes according to MSDS guidelines.
3. Reconnect detector to pipeline.

### Replacing Circuit Board

If the circuit board is damaged, follow these instructions to replace it.

1. Unplug the electrode and coil plugs.
2. Unscrew and remove screws S1-S4.

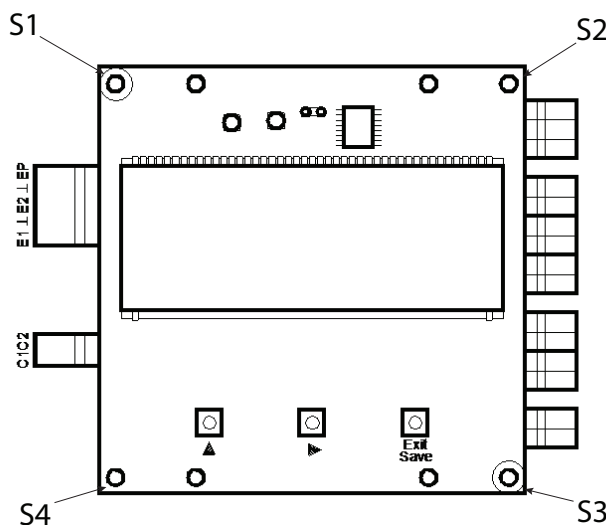

4. Remove the old circuit board.
5. Insert the new circuit board.
6. Secure it by fastening S1-S4 screws. Plug in the electrode and coil plugs.
7. If necessary, configure new circuit board related to the available meter (detector, size).

## TROUBLESHOOTING

The M5000 mag meter is designed for many years of optimal performance. However, should it malfunction, there are certain things that we recommend you check before contacting our Technical Support department or your local Badger Meter Representative.

**NOTE:** If the fluid measured has a high concentration of conductive solids, deposits may accumulate on the internal liner walls and electrodes. These deposits cause a reduction of the measuring output. Thus, Badger Meter recommends that you remove the meter and inspect the liner and electrodes after six months. If deposits are found, remove them with a soft brush. Repeat inspection process every six months or until an appropriate inspection cycle can be established for the specific application.

Other general conditions include:

Description	Possible Cause	Recommended Action
Flow is present but display is "0"	Disconnected signal cable	Check signal cable
	Detector mounted opposite of the main flow direction (see arrow on the nameplate)	Turn detector 180° or switch terminal E1 and E2 or reprogram to bidirectional mode
	Coil or electrode cables exchanged	Check cable connections for cross wiring
	Improper low flow cutoff or full scale flow	Replace configuration defaults
Inaccurate measuring	Improper calibration	Check the parameters (detector factor and size) according to supplied data sheet
	Wrong calibration parameter	
	Pipe not fully filled, or air in pipe	Check if meter is completely filled with fluid
	Invalid fluid conductivity	Purge line to eliminate air bubbles
	Invalid fluid mixture	
	Missing or insufficient grounding	Verify grounding and fix any problems
Blank display	Dead battery	Replace battery
Flow rate value known to be wrong	Detector factor	Check value on label
	Deposits on electrodes and/or liner	Check and remove deposits
	Incorrect pipe size programmed	Check size if necessary
Flow rate indication unstable	Cable issue	Make sure cable is shielded and not vibrating
	Grounding issue	Make sure meter is properly grounded to a good earth ground
	Partially full pipe	Make sure pipe is full of fluid
	Air in pipe	Make sure fluid does not contain air bubbles
	Invalid fluid conductivity	Make sure amplifier is not too close to sources of electrical interference
BEACON displays multiple estimated flow occurrences for meters connected to ORION® Cellular LTE endpoints	ORION Cellular LTE endpoints require additional resistance	Add a 15K resistor to the M5000 terminal block. See <a href="#">"Adding Resistor with ORION Cellular LTE" on page 45</a>

## Errors and Warnings

What You See	Why It Happened	How to Fix It
MEASURE_TIMEOUT	The board may be damaged.	Contact Badger Meter Technical Support.
COMMON_MODE_VOLTAGE_OVERLOAD	Common mode voltage is smaller than -2.0V or larger than +4.1V.	Make sure the meter is properly grounded.
	Empty detector.	Switch Empty Pipe detection ON.
	Dirty electrodes.	Clean the electrodes.
EMPTY_PIPE_WARNING	Measured impedance between the Empty Pipe electrode and the Ground exceeded the set value.	<ul style="list-style-type: none"> <li>Make sure the pipe is filled.</li> <li>Check Empty Pipe threshold. It should be 60000 Ω (corresponds with 20 μS/cm).</li> </ul>
	Empty detector.	
PULSE_OVERLOAD_WARNING	Overflow occurred on the flow output.	Lower the pulse number.
FLOW_OVERLOAD_WARNING	Flow exceeded the Full Scale of more than 100%.	Set the flow range properly.
LOW_POWER_WARNING	Battery voltage is smaller than 3.0V.	Consider replacing the battery.
EEPROM_ERROR	Configuration file is missing.	Replace the circuit board.
CONFIG_ERROR	Configuration file is corrupted.	Replace the circuit board.
PREAMPLIFIER_OVERLOAD	Input voltage exceeded the limits.	Maximum polarization is ± 227 mV; maximum power line noise is 10.6 mV; maximum useful signal is 10.7 mV.
	Empty detector.	Switch Empty Pipe detection ON.
	Dirty electrodes.	Clean the electrodes.
COIL_ERROR	Coil/sensor is not connected.	<ul style="list-style-type: none"> <li>Make sure wiring is properly connected to the amplifier.</li> <li>If that does not clear the alarm, contact Badger Meter Technical Support.</li> </ul>
	Coil shorted.	
	Issue with coil current.	

When one of the errors occurs, the meter stops measuring until the error disappears; then the meter resumes measuring.

### Repair of Faults

Disconnect all units from power supply and have it repaired by a qualified service person if any of the following occurs:

- Power cord or plug is damaged or frayed.
- Unit does not operate normally when operating instructions are followed.
- Unit is exposed to rain/water or liquid is spilled into it.
- Unit is dropped or damaged.
- Unit shows a change in performance, indicating a need for service.

## CONNECTING AN ORION RTR® ENDPOINT TO THE M5000 METER

**NOTE:** Connect the endpoint as described. If there is a reading on the M5000, program the endpoint to match that reading or reset the totalizer. The endpoint requires programming per the endpoint user manual.

### Wiring

To connect the RTR endpoint to Output #1 on the M5000, connect the red wire to the positive (+) terminal and the black and green wire to the negative (-) terminal.

To connect the RTR endpoint to Output #2 on the M5000, connect the red wire to the positive (+) terminal and the black and green wire to the negative (-) terminal.

### Programming

To program the M5000 meter for the endpoint to Output #1 (forward flow):

1. Navigate to *IN/OUT > Simulat > Outputs > Puls/unit*.
2. Use the arrows to change the values, then press **EXIT/SAVE**.
3. Repeat steps 1 and 2 for *Width, Out 1 Func and Out 1 Type*.

**NOTE:** For Output #2 (forward flow), use *Out 2 Func* and *Out 2 Type* instead.

## CONNECTING AN ORION ENCODER ENDPOINT TO THE M5000 METER

**NOTE:** Once connected, the endpoint automatically updates within one hour. You can force an update using the Endpoint Utility software. See the "ORION Endpoint Utility" user manual for programming information available at [www.badgermeter.com](http://www.badgermeter.com).

### Wiring

Connect the encoder endpoint to the meter:

Encoder Wire	M5000 Terminal
Red (Power/Clock)	Input +
Green (Data)	Out 4 +
Black (Ground)	Out 4 -

Connect a jumper wire from Out 4 negative (-) to INPUT negative (-).

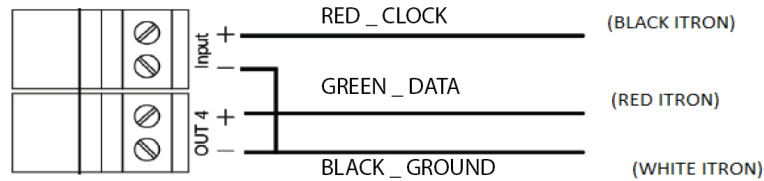

Figure 36: M5000 endpoint connection

### Adding Resistor with ORION Cellular LTE

When connected to an ORION Cellular LTE endpoint, additional resistance is required. Add a 15K resistor to the M5000 terminal block between Input + (red wire) and Out 4 + (green wire) as shown. The resistor is represented in red in [Figure 37](#).



Figure 37: ORION Cellular LTE endpoint connection with resistor

Order resistor kit P/N 69224-001 from Badger Meter.

### Programming

Changing the following settings automatically configures *Input* and *Output 4* for ADE.

To program the M5000 meter for the endpoint to Output #1 (forward flow):

1. Navigate to *COMMUNIC > INTERFAC > ADE > CONTROL*.
2. Use the arrows to change the values, then press **EXIT/SAVE**.
3. Repeat steps 1 and 2 for *Control, Protocol, Dials and Resolution* (the Resolution range is 0.0001...10,000).
4. Press **EXIT/SAVE**.

## SPECIFICATIONS

**NOTE:** Measurements in DN are for Nominal Diameter in mm.

### M5000 Amplifier

<b>Flow Range</b>	0.1...32.8 ft/s (0.03...10 m/s)	
<b>Accuracy</b>	± 0.4% of measured value ± 2 mm/s OIML/MID: 2...12 in. (DN50...300) with 0d up and 0d downstream ±1% ≥ 1.2 ft/s (0.35 m/s)	
<b>Repeatability</b>	± 0.1%	
<b>Ambient Temperature</b>	-4...140° F (-20...60° C)	
<b>Flow Direction</b>	Uni-directional or bi-directional. Two separate programmable totalizers for uni-directional measurement.	
<b>Digital Outputs (4)</b>	Galvanically isolated open collector, 30V DC maximum, 20 mA each, maximum output frequency at 100 Hz	
<b>Status Outputs</b>	ADE, High/low flow alarm (0...100% of flow), error alarm, empty pipe alarm, flow direction	
<b>Communication</b>	RS232, Modbus RTU, IrDA, M-Bus, RS 485 (optional), External AMR or GSM/GPRS module (optional)	
<b>Empty Pipe Detection</b>	Separate electrode, field-tunable for optimum performance based on specific application	
<b>Min-Max Flow Alarm</b>	Programmable outputs 0...100% of flow	
<b>Low Flow Cut-Off</b>	Programmable 0...10% of maximum flow	
<b>Galvanic Separation</b>	Functional 500 volts	
<b>Pulse Width</b>	Programmable 5...500 ms	
<b>Coil Power</b>	Pulsed DC	
<b>Sampling Rate</b>	Programmable from 1 to 63 seconds. Standard sampling period is 15 seconds.	
<b>Display</b>	Two lines x 15 characters (7 on top + 8 on bottom), LCD display	
<b>Programming</b>	Three external buttons	
<b>Units of Measure</b>	Gallons, ounces, MGD, liters, cubic meters, cubic feet, imperial gallon, barrel, hectoliter and acre feet	
<b>Battery Life</b>	<i>Standard:</i> 10 years with one battery pack; <i>optional:</i> up to 20 years with two battery packs for sizes 6 in. (DN 150) or smaller.	
<b>Power Supply</b>	<i>Standard:</i> Internal lithium batteries 3.6 volt, optional external battery pack <i>Optional:</i> battery back-up model (100...240V AC or 9...36V DC)	
<b>Processing</b>	Low power microcontroller (16 bit)	
<b>Amplifier Housing</b>	NEMA 4X (IP67, optional IP68), cast aluminum, powder-coated paint	
<b>Mounting</b>	Detector-mount or remote wall mount (bracket supplied)	
<b>Meter Enclosure Classification</b>	<i>Standard:</i> NEMA 4X (IP67); <i>Optional:</i> Submersible NEMA 6P IP68, remote amplifier required	
<b>Junction Box Enclosure Protection</b>	For remote amplifier option: Powder coated die-cast aluminum, NEMA 4 (IP67)	
<b>Approvals</b>	NSF/ANSI/CAN 61 and 372 Listed OIML R49-1 MID MI-001	Models with hard rubber liner 4 in. (DN 100) size and up; PTFE liner, all sizes.

### M5000 Amplifier Dimensions in Inches (Millimeters)

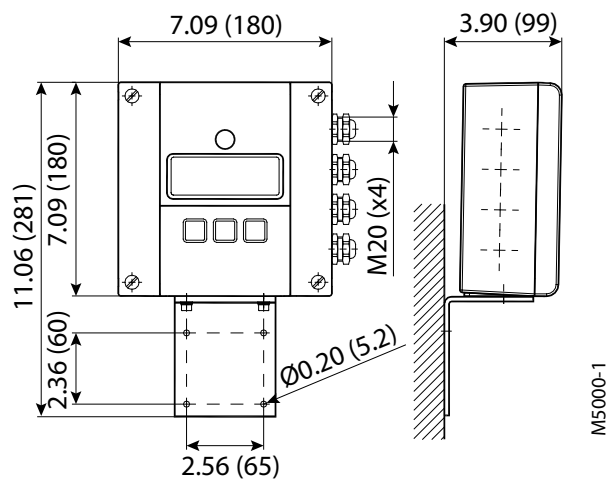

## Detector Type VI

<b>Size</b>	1/2...24 in. (DN 15...600)		
<b>Process Connection</b>	<b>Flange Type</b>	DIN, ANSI, JIS, AWWA and more	
	<b>Material</b>	Standard: carbon steel; optional: stainless steel 304/316	
<b>Pressure Limits</b>	Up to 1450 psi (100 bar) PED		
<b>Meter Enclosure Classification</b>	Standard: NEMA 4X (IP67); Optional: Submersible NEMA 6P IP68, remote amplifier required		
<b>Minimum Conductivity</b>	≥20 µS/cm		
<b>Liners</b>	<b>Material</b>	<b>Available for sizes</b>	<b>Fluid Temp for Remote Mount</b>
	PTFE	1/2...24 in. (DN 15...600)	302° F (150° C)
	Hard rubber	1...24 in. (DN 25...600)	178° F (80° C)
<b>Electrode Materials</b>	Standard: Hastelloy® C; optional: Tantalum, Platinum/Gold plated, Platinum/Rhodium, 316 stainless steel		
<b>Meter Housing Material</b>	Standard: Carbon steel painted; optional: Stainless steel 304/316 or painted in C5M		
<b>Optional Stainless Steel Grounding Rings</b>	<b>ANSI Flanges</b>		<b>All Other Flanges</b>
	Meter Size	Thickness (of 1 ring)	Meter Size
	1/2...1 in. (DN 15...25)	0.135 in. (3.42 mm)	1/2... 24 in. (DN 15...600)
	12...24 in. (DN 300...600)	0.187 in. (4.75 mm)	_____ 0.12 in. (3 mm)

### Remote Version in. (mm)

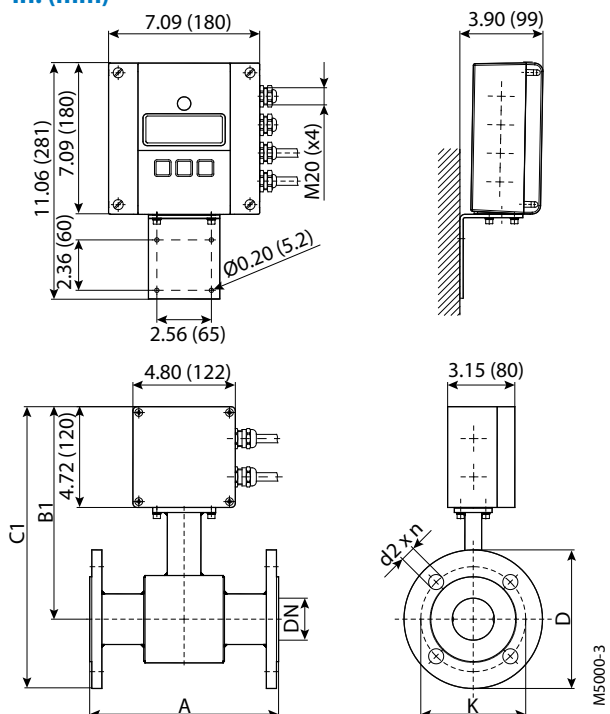

### Mounted Version in. (mm)

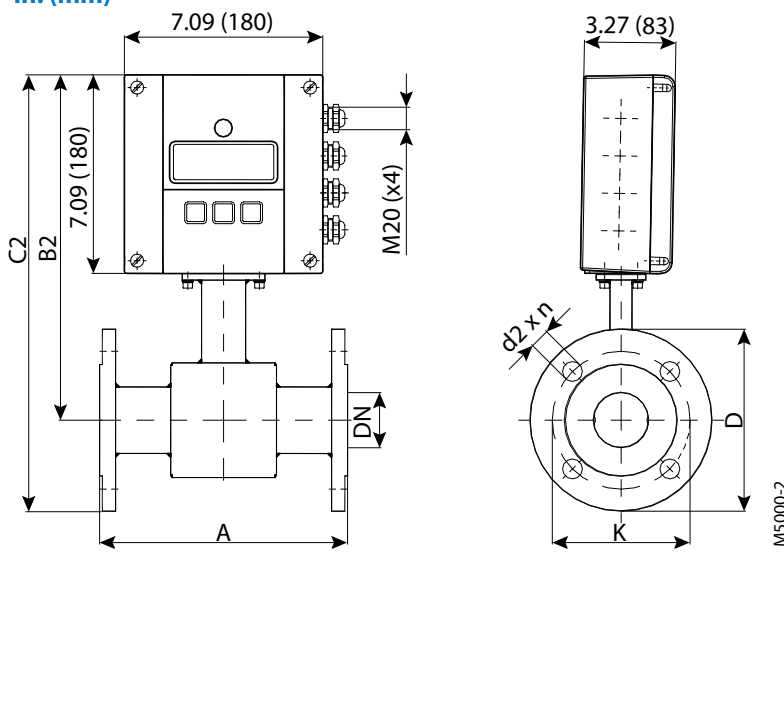

Size in. (DN)	A Std* in. (mm)	A ISO** in. (mm)	B1 in. (mm)	B2 in. (mm)	C1 in. (mm)	C2 in. (mm)	with ANSI-flanges			with DIN-flanges		
							ø D in. (mm)	ø K in. (mm)	ø d2xn in. (mm)	ø D in. (mm)	ø K in. (mm)	ø d2xn in. (mm)
1/2 (15)	6.7 (170)	7.87 (200)	9.37 (238)	11.73 (298)	13.9 (351)	13.4 (342)	3.5 (88.9)	2.37 (60.3)	0.63 x 4 (15.9 x 4)	3.75 (95)	2.56 (65)	0.55 x 4 (14 x 4)
3/4 (20)	6.7 (170)	7.87 (200)	9.37 (238)	11.73 (298)	14 (356)	13.6 (347)	3.9 (98.4)	2.75 (69.8)	0.63 x 4 (15.9 x 4)	4.13 (105)	2.95 (75)	0.55 x 4 (14 x 4)
1 (25)	8.9 (225)	7.87 (200)	9.37 (238)	11.73 (298)	14.2 (361)	13.8 (352)	4.3 (107.9)	3.13 (79.4)	0.63 x 4 (15.9 x 4)	4.53 (115)	3.35 (85)	0.55 x 4 (14 x 4)
1-1/4 (32)	8.9 (225)	7.87 (200)	9.96 (253)	12.32 (313)	15 (381)	14.6 (372)	4.6 (117.5)	3.50 (88.9)	0.63 x 4 (15.9 x 4)	5.51 (140)	3.94 (100)	0.71 x 4 (18 x 4)
1-1/2 (40)	8.9 (225)	7.87 (200)	9.96 (253)	12.32 (313)	15.2 (386)	14.8 (376)	5.0 (127)	3.87 (98.4)	0.63 x 4 (15.9 x 4)	5.91 (150)	4.33 (110)	0.71 x 4 (18 x 4)
2 (50)	8.9 (225)	7.87 (200)	9.96 (253)	12.32 (313)	15.7 (398)	15.3 (389)	6.0 (152.4)	4.75 (120.6)	0.75 x 4 (19 x 4)	6.50 (165)	4.92 (125)	0.71 x 4 (18 x 4)

Size in. (DN)	A Std* in. (mm)	A ISO** in. (mm)	B1 in. (mm)	B2 in. (mm)	C1 in. (mm)	C2 in. (mm)	with ANSI-flanges			with DIN-flanges		
							ø D in. (mm)	ø K in. (mm)	ø d2×n in. (mm)	ø D in. (mm)	ø K in. (mm)	ø d2×n in. (mm)
2-1/2 (65)	11.0 (280)	7.87 (200)	10.67 (271)	13.03 (331)	16.9 (429)	16.5 (420)	7.0 (177.8)	5.50 (139.7)	0.75 × 4 (19 × 4)	7.28 (185)	5.71 (145)	0.71 × 8 (18 × 8)
3 (80)	11.0 (280)	7.87 (200)	10.67 (271)	13.03 (331)	17.2 (435)	16.7 (426)	7.5 (190.5)	6.00 (152.4)	0.75 × 4 (19 × 4)	7.87 (200)	6.30 (160)	0.71 × 8 (18 × 8)
4 (100)	11.0 (280)	9.84 (250)	10.94 (278)	13.31 (338)	18.2 (461)	17.8 (452)	9.0 (228.6)	7.50 (190.5)	0.75 × 8 (19 × 8)	8.66 (220)	7.09 (180)	0.71 × 8 (18 × 8)
5 (125)	15.8 (400)	9.84 (250)	11.73 (298)	14.09 (358)	19.4 (493)	19 (484)	10.0 (254)	8.50 (215.9)	0.85 × 8 (22.2 × 8)	9.84 (250)	8.27 (210)	0.71 × 8 (18 × 8)
6 (150)	15.8 (400)	11.81 (300)	12.20 (310)	14.57 (370)	20.4 (519)	20 (510)	11.0 (279.4)	9.50 (241.3)	0.85 × 8 (22.2 × 8)	11.22 (285)	9.45 (240)	0.87 × 8 (22 × 8)
8 (200)	15.8 (400)	13.78 (350)	13.31 (338)	15.67 (398)	22.9 (583)	21.9 (558)	13.5 (342.9)	11.75 (298.4)	0.85 × 8 (22.2 × 8)	13.39 (340)	11.61 (295)	0.87 × 12 (22 × 12)
10 (250)	19.7 (500)	17.72 (450)	14.25 (362)	16.61 (422)	26.6 (676)	26.2 (677)	16.0 (406.4)	14.25 (361.9)	1.00 × 12 (25.4 × 12)	15.55 (395)	13.78 (350)	0.87 × 12 (22 × 12)
12 (300)	19.7 (500)	19.69 (500)	16.73 (425)	19.09 (485)	28.7 (729)	28.3 (720)	19.0 (482.6)	17.00 (431.8)	1.00 × 12 (25.4 × 12)	17.52 (445)	15.75 (400)	0.87 × 12 (22 × 12)
14 (350)	19.7 (500)	21.65 (550)	17.72 (450)	20.08 (510)	30.7 (779)	30.2 (768)	21.0 (533.4)	18.75 (476.2)	1.13 × 12 (28.6 × 12)	19.88 (505)	18.11 (460)	0.87 × 16 (22 × 16)
16 (400)	23.6 (600)	23.62 (600)	18.70 (475)	21.06 (535)	33.5 (851)	33.1 (842)	23.5 (596.9)	21.25 (539.7)	1.13 × 16 (28.6 × 16)	22.24 (565)	20.28 (515)	1.02 × 16 (26 × 16)
18 (450)	23.6 (600)	—	19.69 (500)	22.05 (560)	34.9 (885)	34.4 (876)	25.0 (635.0)	22.75 (577.8)	1.25 × 16 (31.7 × 16)	24.21 (615)	22.24 (565)	1.02 × 20 (26 × 20)
20 (500)	23.6 (600)	—	20.67 (525)	23.03 (585)	38 (964)	337.6 (955)	27.5 (698.5)	25.00 (635.0)	1.25 × 20 (31.7 × 20)	26.38 (670)	24.41 (620)	1.02 × 20 (26 × 20)
22 (550)	23.6 (600)	—	21.65 (550)	24.02 (610)	39.4 (1000)	39 (991)	29.5 (749.3)	27.25 (692.1)	1.37 × 20 (34.9 × 20)	—	—	—
24 (600)	23.6 (600)	—	23.15 (588)	25.51 (648)	42 (1066)	41.6 (1057)	32.0 (812.8)	29.50 (749.3)	1.37 × 20 (34.9 × 20)	30.71 (780)	28.54 (725)	1.18 × 20 (30 × 20)
Standard												
with ANSI-flanges		1/2...24 in.		Nominal Pressure 150 psi (10 bar)								
with DIN flanges		DN 15...200		Nominal Pressure 232 psi (16 bar)								
		DN 250...600		Nominal Pressure 150 psi (10 bar)								
Standard **ISO 20456												



### Error Limits

<b>Measuring range</b>	0.10...39.37 ft/s (0.03...12 m/s)
<b>Pulse output</b>	±0.4% of m.v. ±0.08 in./s (2 mm/s)
<b>Repeatability</b>	±0.1% of actual data

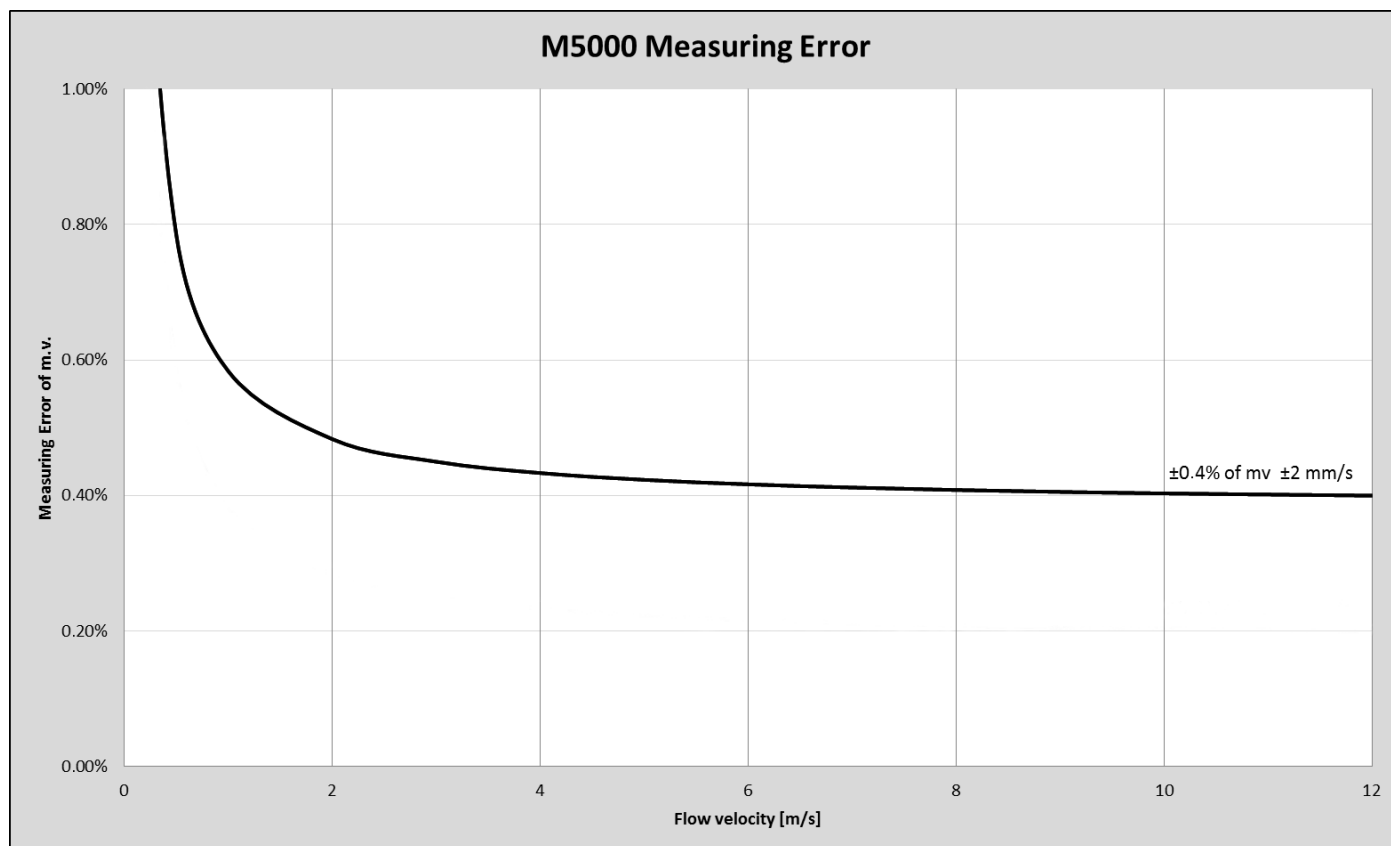

<b>Reference conditions</b>	
<b>Ambient and fluid temperature</b>	68° F (20° C)
<b>Electr. conductivity</b>	> 300 µS/cm
<b>Warm-up period</b>	60 min
<b>Mounting conditions</b>	> (10 DN) inlet pipe
	> (5 DN) outlet pipe
	Detector properly grounded and centered

## OIML APPROVED METER

The M5000 is type approved according to the international water meter standards OIML R49. The meter is approved as Class I and Class II for the detector sizes 2...12 inches (DN 50...300).

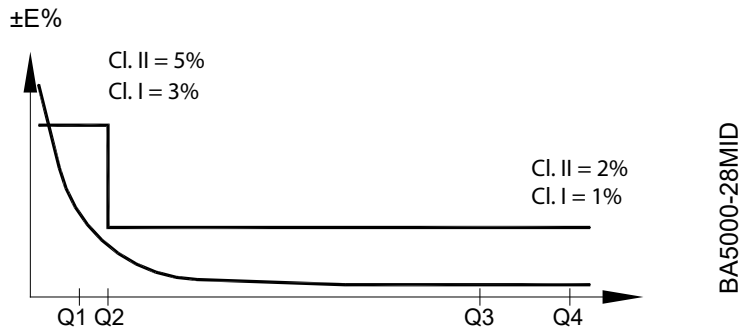

$Q2/Q1 = 1.6$  and  $Q4/Q3 = 1.25$

OIML R 49 specification for Class I

Size in. (DN)	2 (50)	2 1/2 (65)	3 (80)	4 (100)	5 (125)	6 (150)	8 (200)	10 (250)	12 (300)
R (Q3/Q1)	200	200	200	250	250	160	160	160	100
Q1 [m <sup>3</sup> /h]	0.315	0.5	0.8	1	1.6	3.94	6.25	10	15.63
Q2 [m <sup>3</sup> /h]	0.504	0.8	1.28	1.6	2.56	6,3	10	16	25
<b>Q3 [m<sup>3</sup>/h]</b>	<b>63</b>	<b>100</b>	<b>160</b>	<b>250</b>	<b>400</b>	<b>630</b>	<b>1000</b>	<b>1600</b>	<b>1600</b>
Q4 [m <sup>3</sup> /h]	78.75	125	200	312.5	500	787.5	1250	2000	2000
OIML R49 Class	1								

OIML R 49 specification for Class II

Size in. (DN)	6 (150)	8 (200)
R (Q3/Q1)	250	250
Q1 [m <sup>3</sup> /h]	2.52	4
Q2 [m <sup>3</sup> /h]	4.03	6.4
<b>Q3 [m<sup>3</sup>/h]</b>	<b>630</b>	<b>1000</b>
Q4 [m <sup>3</sup> /h]	787.5	1250
OIML R49 Class	2	

## MID Approved Meter (MI-001)

The M5000 is type approved according to Directive 2004/22/EC of the European Parliament and Council of March 31, 2004 Measuring Instruments (MID) Annex MI-001. The meter is approved for the detector sizes 2...12 inches (DN 50...300).

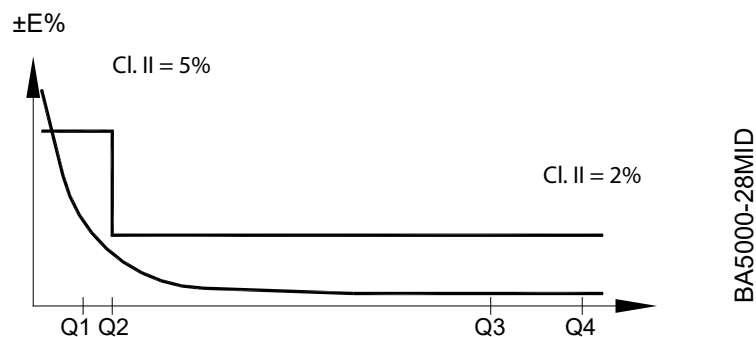

$Q2/Q1 = 1.6$  and  $Q4/Q3 = 1.25$

Size in. (DN)	2 (50)	2-1/2 (65)	3 (80)	4 (100)	5 (125)	6 (150)	8 (200)	10 (250)	12 (300)
R (Q3/Q1)	200	200	200	250	250	250	250	160	160
Q1 [m <sup>3</sup> /h]	0.315	0.5	0.8	1	1.6	2.52	4	10	15.63
Q2 [m <sup>3</sup> /h]	0.504	0.8	1,28	1.6	2.56	4.03	6.4	16	25
<b>Q3 [m<sup>3</sup>/h]</b>	<b>63</b>	<b>100</b>	<b>160</b>	<b>250</b>	<b>400</b>	<b>630</b>	<b>1000</b>	<b>1600</b>	<b>1600</b>
Q4 [m <sup>3</sup> /h]	78.75	125	200	312.5	500	787.5	1250	2000	2000

The conformity declaration of above certificate is according to module B (type approval) and D (quality insurance of production).

## REPLACEMENT PARTS

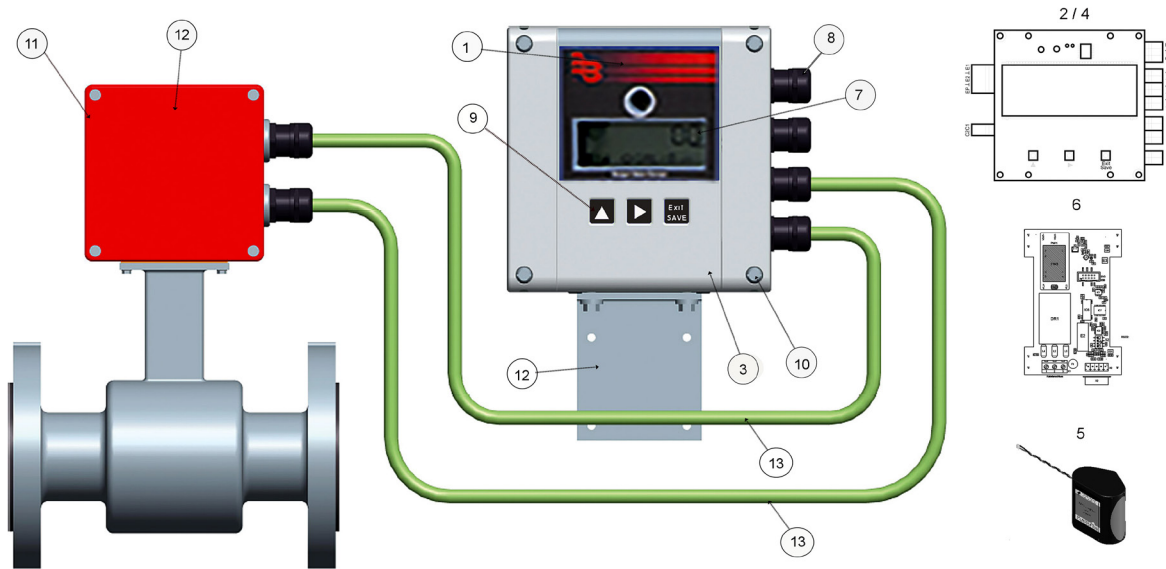

**NOTE:** For remote applications, two cables are required: An electrode cable and a coil cable.

Pos.	Description	North American Part no.	International Part no.		
1	Amplifier assembly complete				
	Complete without Batteries	—	592603		
	Complete with 2 D-cells	66902-003	592600		
	Complete with 4 D-cells	66902-004	592601		
2	PCB board assembly with amplifier cover, ADE and M-Bus	66902-007	384748		
	PCB board assembly with amplifier cover and RS485	66902-008	384759		
3	Housing / Cover (Complete)	66902-002	384735		
4	LCD display (only available with board)				
5	Battery pack 2 D-cells	66902-006	384776		
	Battery pack 4 D-cells	66902-005	384777		
6	Battery back-up board AC	—	384701		
	Battery back-up board DC	—	384741		
7	Display window	—	384709		
8	Cable gland	66862-001	384732		
9	Buttons kit black	—	384707		
10	Housing screws / Ball screws (Qty. 4)	66312-001	384607		
11	IP68 kit for remote version	—	383077		
12	Remote mounting kit less cable	63384-043	384870		
13	Remote mounting kit with cable				
		<b>North America</b>		<b>International</b>	
		<b>Electrode Cable</b>	<b>Coil Cable</b>	5 m	384871
	<b>A-Cable: 15 ft</b>	66897-001	66896-001	10 m	384872
	<b>B-Cable: 30 ft</b>	66897-002	66896-002	15 m	384873
	<b>C-Cable: 50 ft</b>	66897-003	66896-003	20 m	384874
	<b>D-Cable: 100 ft</b>	66897-004	66896-004	25 m	384875
	—		30 m	384876	

---

<b>Pos.</b>	<b>Description</b>	<b>North American Part no.</b>	<b>International Part no.</b>
	Data logging kit (required for firmware update)	67354-008	—
	Verification device	66849-001	—
—	PC programming kit via USB/RS232	—	592604
	PC programming kit via IrDA	—	592605
	Grounding ring kits (for specific sizes, refer to the parts price list or contact your customer service account representative)	63528-xxx	—

**INTENTIONAL BLANK PAGE**

**INTENTIONAL BLANK PAGE**

**Control. Manage. Optimize.**

ModMAG and ORION are registered trademarks of Badger Meter, Inc. Other trademarks appearing in this document are the property of their respective entities. Due to continuous research, product improvements and enhancements, Badger Meter reserves the right to change product or system specifications without notice, except to the extent an outstanding contractual obligation exists. © 2021 Badger Meter, Inc. All rights reserved.

[www.badgermeter.com](http://www.badgermeter.com)